

## MS32

Page 2-2



- Width 45 mm
- With thermal and magnetic releases
- Setting ranges 0.1 - 32 A (15 different choices)
- Short-circuit breaking capacity  $I_{cu}$  at 400 V: from 100 to 25 kA
- UL, EAC
- Accessories

## MS25

Page 2-19



- Width 45 mm
- With thermal and magnetic releases
- Setting ranges 0.1 - 25 A (13 different choices)
- Short-circuit breaking capacity  $I_{cu}$  at 400 V: from 50 to 4 kA
- UL, CSA, EAC
- Accessories

## MST25

Page 2-19



- Width 45 mm
- With a thermal release only
- Setting ranges 0.25 - 25 A (11 different choices)
- UL, CSA, EAC
- Accessories

MOTOR PROTECTION CIRCUIT BREAKERS ARE USED FOR START-UP AND PROTECTION OF ELECTRIC MOTORS (INDUSTRY, SMALL MACHINES, EXTERNAL USE, AGRICULTURAL MACHINES, COMPRESSORS, REPAIR SHOPS, ETC.).



MOTOR PROTECTION CIRCUIT BREAKERS ARE SPECIAL TYPE OF CIRCUIT BREAKERS DESIGNED FOR PROTECTION OF WIDE RANGE OF SINGLE-PHASE AND THREE-PHASE AC MOTORS AGAINST OVERLOAD AND SHORT CIRCUIT. THEY ARE USED IN INDUSTRY, SMALL MACHINES, AGRICULTURAL MACHINES, COMPRESSORS ETC.



## FOR MOTOR PROTECTION:

- All kind of AC induction motors
- For three-phase motors up to 22 kW

## PROTECTION OF OTHER LOADS:

- Various low-inductive loads
- Version for transformer protection MS32-TR

## OTHER BENEFITS:

- Manual control:
  - START, STOP, push-buttons - with a trip indication (i.e. push-buttons stay in the middle position)
- Automatic switch-off at over-current with thermal or magnetic release
- Control with under-voltage release or shunt release
- An auxiliary switch for side mounting or flush mounting used for indication of the switching state
- Indication of release with trip indicating auxiliary switch
- ON/OFF buttons positions unequivocally indicates switching position of main contacts
- Contact material :
  - resistant to contact welding
  - enables low contact heating
- Isolating distance between contacts: 4.5 mm per contact place
- Connection of a rigid or flexible conductor
- Assembly to 35 mm wide mounting rail in compliance with EN 60715
- Vertical or horizontal operational position

## ORDERING DATA

Motor protection circuit breakers MS32 up to 32 A .....	page 2-3
Accessories .....	page 2-4
Accessories - general .....	page 2-14
Example for Ordering data .....	page 2-3
Technical characteristics .....	page 2-15
Dimensions .....	page 2-25

# MOTOR PROTECTION CIRCUIT BREAKERS - MS32

2

Motor protection circuit-breakers areas of use

Type	Motor protection	Overload protection	Short-circuit protection	Single-phase consumers	Transformer protection
MS18	■	■	■	■	
MS32	■	■	■	■	
MS32-TR		■	■		■

## MOTOR PROTECTION CIRCUIT BREAKERS MS32

With overload and short-circuit release

AC-3 acc. to IEC/EN 60947-4-1

Type	Setting range (A)	Motor power (3-phase, 400 V) (kW)	Ordering No.	Weight (g)	Packaging (pcs)
MS32-0.16	0.1 ... 0.16		30.108.757	279	1
MS32-0.25	0.16 ... 0.25	0.06	30.108.758	279	1
MS32-0.4	0.25 ... 0.4	0.09	30.108.759	279	1
MS32-0.63	0.4 ... 0.63	0.12 ... 0.18	30.108.760	279	1
MS32-1	0.63 ... 1	0.18 ... 0.25	30.108.761	279	1
MS32-1.6	1 ... 1.6	0.37 ... 0.55	30.108.762	279	1
MS32-2.5	1.6 ... 2.5	0.75	30.108.763	279	1
MS32-4	2.5 ... 4	1.1 ... 1.5	30.108.764	279	1
MS32-6.3	4 ... 6.3	2.2	30.108.765	279	1
MS32-10	6.3 ... 10	3 ... 4	30.108.766	279	1
MS32-14	9 ... 14	5.5	30.108.767	279	1
MS32-18	13 ... 18	7.5	30.108.768	279	1
MS32-23	17 ... 23	9 ... 11	30.108.769	279	1
MS32-27	23 ... 27	11	30.108.770	279	1
MS32-32	25 ... 32	15	30.108.771	279	1



## CIRCUIT BREAKERS FOR TRANSFORMER PROTECTION MS32TR

With overload and short-circuit release

AC-3 acc. to IEC/EN 60947-4-1

Type	Setting range (A)	Ordering No.	Weight (g)	Packaging (pcs)
MS32TR-2.5	1.6 ... 2.5	30.109.359	279	1
MS32TR-4	2.5 ... 4	30.109.360	279	1
MS32TR-6.3	4 ... 6.3	30.109.361	279	1
MS32TR-10	6.3 ... 10	30.109.362	279	1
MS32TR-14	9 ... 14	30.109.363	279	1
MS32TR-18	13 ... 18	30.109.364	279	1
MS32TR-23	17 ... 23	30.109.365	279	1
MS32TR-27	23 ... 27	30.109.366	279	1
MS32TR-32	25 ... 32	30.109.367	279	1



## ORDERING DATA

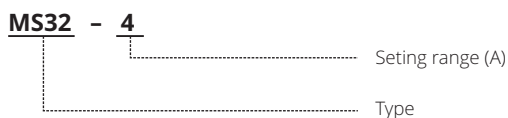

### EXAMPLE:

The same switch with under-voltage release for control voltage 380 V with an auxiliary switch with two NO contacts, built in the enclosure, with an emergency stop push-button and green signal lamp for 230 V:



MS32 - 4 / UR 380 / HS 20 / HO41 / NAT / SSz 230

ORDERING DATA

## MS32

### Auxiliary contact block HSV

AC-15, DC-13 acc. to IEC/EN 60947-5-1

Type	Number of contacts		Wiring diagram	Ordering No.	Weight (g)	Packaging (pcs)
	NO	NC				
HSV10	1	0		38.902.521	32	1
HSV01	0	1		38.902.520	32	1





2

- HSV contact changes position from its normal state when the MS32 MPCB is switched on.

### Trip-indicating contact block HRS

AC-15, DC-13 acc. to IEC/EN 60947-5-1



Type	Number of contacts		Wiring diagram	Ordering No.	Weight (g)	Packaging (pcs)
	NO	NC				
HRS10	1	0		38.902.523	32	1
HRS01	0	1		38.902.522	32	1



- HRS contact changes position from its normal state when the MS32/MS18 MPCB trips due to overload, short-circuit or manual depression of the TEST lever.

### Auxiliary contact block for lateral mounting HS

AC-15, DC-13 acc. to IEC/EN 60947-5-1

Type	Number of contacts		Wiring diagram	Ordering No.	Weight (g)	Packaging (pcs)
	NO	NC				
HS10	1	0		38.902.456	32	1
HS11	1	1		38.902.458	32	1
HS20	2	0		38.902.460	32	1



### Adapters for connection of MS32 with a contactor

Type	Used for	Ordering No.	Weight (g)	Packaging (pcs)
MSK07	K07	30.018.211	10	10
MSKNL9	KNL9 ... KNL18	30.018.212	10	10
MSKNL22	KNL22 ... KNL30	30.018.213	10	10



ORDERING DATA

# MOTOR PROTECTION CIRCUIT BREAKERS - ACCESSORIES

## MS32

### Under-voltage release UR

Voltage (V)*	Frequency (Hz)	Ordering No.	Weight (g)	Packaging (pcs)
24	50	38.902.534	62	1
24	60	38.902.535	62	1
110	50	38.902.941	62	1
110	60	38.902.536	62	1
230	50	38.902.461	62	1
230	60	38.902.943	62	1
240	50	38.902.524	62	1
240	60	38.902.537	62	1
400	50	38.902.634	62	1
400	60	38.902.947	62	1
415	50	38.902.533	62	1
415	60	38.902.949	62	1
480	50	38.902.951	62	1
480	60	38.902.538	62	1
500	50	38.902.952	62	1
500	60	38.902.939	62	1
600	50	38.902.954	62	1
600	60	38.902.539	62	1

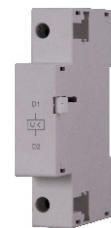

2

### Shunt release AR

Voltage (V)*	Frequency (Hz)	Ordering No.	Weight (g)	Packaging (pcs)
24	50	38.902.574	62	1
24	60	38.902.575	62	1
110	50	38.902.940	62	1
110	60	38.902.576	62	1
230	50	38.902.462	62	1
230	60	38.902.942	62	1
240	50	38.902.525	62	1
240	60	38.902.944	62	1
400	50	38.902.945	62	1
400	60	38.902.946	62	1
415	50	38.902.573	62	1
415	60	38.902.948	62	1
480	50	38.902.950	62	1
480	60	38.902.578	62	1
500	50	38.902.579	62	1
500	60	38.902.938	62	1
600	50	38.902.953	62	1
600	60	38.902.955	62	1



\* UR and AR releases for other control voltage/frequencies are on request.

### Enclosures for MS32

Type	Degree of protection	Ordering No.	Weight (g)	Packaging (pcs)
Enclosure HO-41	IP41	38.423.019	222	1
Enclosure HO-55	IP55	38.423.020	222	1
Frame FP-41	IP41	38.423.111	158	1
Frame FP-55	IP55	38.423.112	158	1
Front plate P-41	IP41	37.425.102	200	1
Front plate P-55	IP55	38.423.137	200	1



P-41/55



FP-41/55



HO-41/55

ORDERING DATA

# MOTOR PROTECTION CIRCUIT BREAKERS - ACCESSORIES

MS32

Accessories for enclosures HO-41/55, FP-41/55, P-41/55

Type	Voltage	Ordering No.	Weight (g)	Packaging (pcs)
Emergency stop push-button <b>E</b>	/	38.902.528	40	1
Emergency stop push-button with keylock <b>E-K</b>	/	38.902.530	40	1
Padlocking feature <b>HZ</b>	/	38.423.095	95	1
Push-button diaphragm <b>IP55</b>	/	38.423.113	12	1
Neutral link <b>NL</b>	/	38.552.076	525	25
Signal lamp <b>SSr</b> (Red)	250 V	623.000.131	175	25
	400 V	623.009.261		
Signal lamp <b>SSz</b> (Green)	250 V	623.009.257	175	25
	400 V	623.009.262		
Signal lamp <b>SSb</b> (Transparent)	250 V	623.009.256	175	25
	400 V	623.009.263		
Cable inlet M25 x 1.5	/	315.609.520	15	100



2

ORDERING DATA

## MS32

### Connection blocks

MSK07, MSKNL9 and MSKNL22 adapters are used for connecting a motor protection switch with a contactor forming a single-unit starter for quick assembly to a 35 mm wide mounting rail (EN 60715).

- **MSK07** - Adapter for connecting MS32 motor protection switch with K07 mini contactor
- **MSKNL9** - Adapter for connecting MS32 motor protection switch with KNL9-KNL18 contactor
- **MSKNL22** - Adapter for connecting MS32 motor protection switch with KNL22, KNL30 contactor

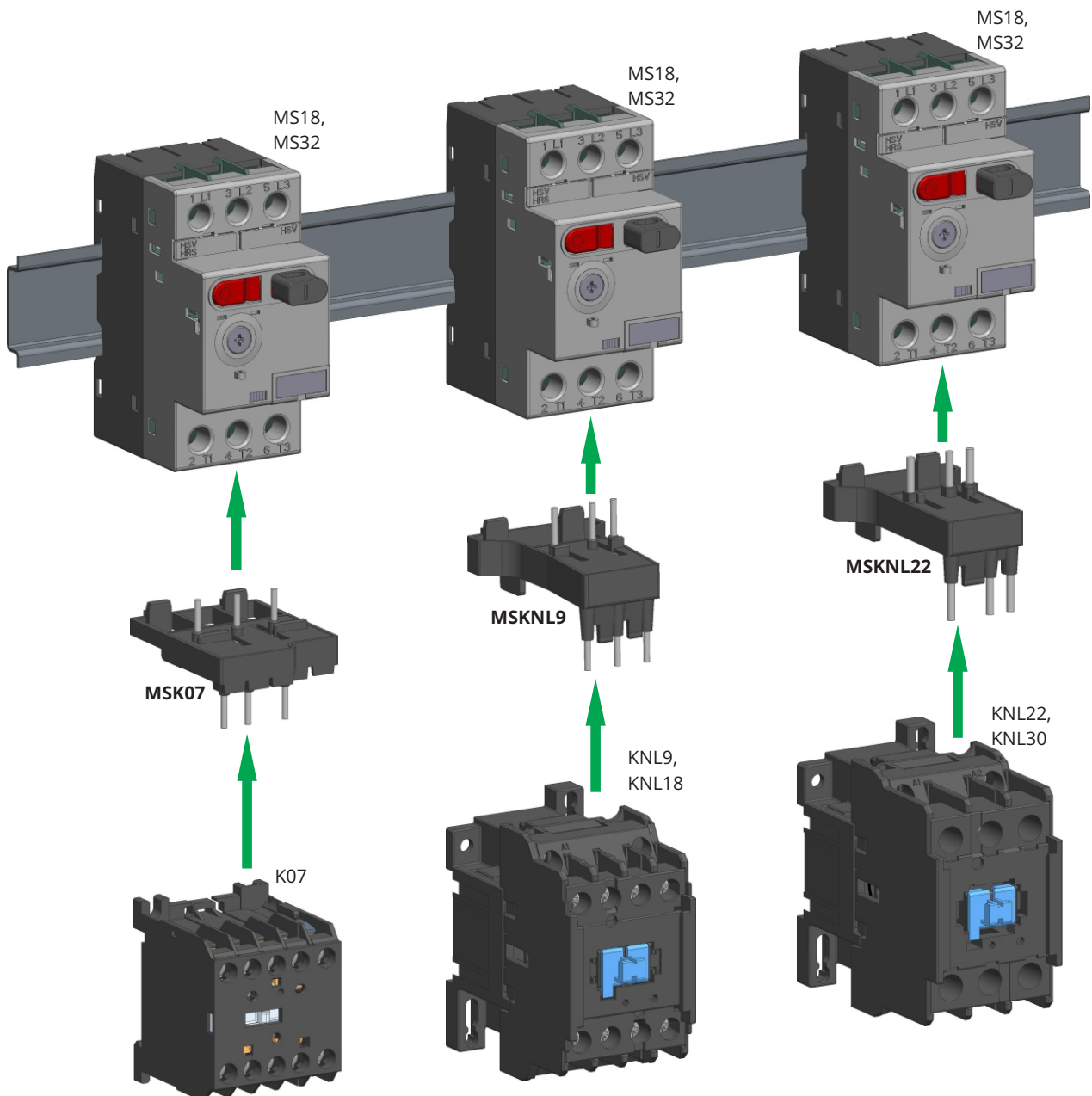



MOTOR PROTECTION CIRCUIT BREAKERS ARE SPECIAL TYPE OF CIRCUIT BREAKERS, DESIGNED FOR PROTECTION OF WIDE RANGE OF SINGLE-PHASE AND THREE-PHASE AC MOTORS AGAINST OVERLOAD AND SHORT CIRCUIT. THEY ARE USED IN INDUSTRY, SMALL MACHINES, AGRICULTURAL MACHINES, COMPRESSORS, ETC.



## FOR MOTOR PROTECTION:

- All kind of AC induction motors
- For three-phase motors up to 18.5 kW

## PROTECTION OF OTHER LOADS:

- Various low-inductive loads
- Version with a thermal overload release for single-phase consumers MST20
- Version with thermal and magnetic release for single-phase consumers Ms20
- Version for short-circuit protection MSZ25
- Version for transformer protection MS32-TR

## OTHER BENEFITS:

- Manual control:
  - START, STOP, push-buttons - Test of release function (TEST)
- Automatic switch-off at over-current with thermal or magnetic release
- Control with under-voltage release or shunt release
- An auxiliary switch for side mounting or flush mounting used for indication of the switching state
- Indication of release with trip indicating auxiliary switch
- ON/OFF buttons positions unequivocally indicates switching position of main contacts
- Contact material :
  - resistant to contact welding
  - enables low contact heating
- Isolating distance between contacts: 4.5 mm per contact place
- Connection of a rigid or flexible conductor
- Assembly to 35 mm wide mounting rail in compliance with EN 60715
- Vertical or horizontal operational position

## ORDERING DATA

Motor protection circuit breakers MS25 up to 25 A .....	page 2-9
Accessories .....	page 2-11
Accessories - general .....	page 2-14
Example for Ordering data .....	page 2-10
Technical characteristics .....	page 2-20
Dimensions .....	page 2-26



# MOTOR PROTECTION CIRCUIT BREAKERS - MS25

2

## Motor protection circuit-breakers areas of use

Type	Motor protection	Overload protection	Short-circuit protection	Single-phase consumers	Transformer protection
MS25	■	■	■	■	
MST25	■	■		■	
MS20	■	■	■	■	
MS25-TR		■	■		■
MSZ25			■	■	
MPE				■	

## MOTOR PROTECTION CIRCUIT BREAKERS MS25

With overload and short-circuit release

AC-3 acc. to IEC/EN 60947-4-1

Type	Setting range (A)	Motor power (3-phase, 400 V) (kW)	Ordering No.	Weight (g)	Packaging (pcs)
MS25-0.16	0.1 ... 0.16	0.02	30.107.955	252	1
MS25-0.25	0.16 ... 0.25	0.06	30.107.956	252	1
MS25-0.4	0.25 ... 0.4	0.09	30.107.957	252	1
MS25-0.63	0.4 ... 0.63	0.12	30.107.958	252	1
MS25-1	0.63 ... 1	0.18 ... 0.25	30.107.959	252	1
MS25-1.6	1 ... 1.6	0.37 ... 0.55	30.107.960	252	1
MS25-2.5	1.6 ... 2.5	0.75 ... 1.1	30.107.961	252	1
MS25-4	2.5 ... 4	1.1 ... 1.5	30.107.962	252	1
MS25-6.3	4 ... 6.3	2.2 ... 2.5	30.107.963	252	1
MS25-10	6.3 ... 10	3 ... 4	30.107.964	252	1
MS25-16	10 ... 16	5 ... 7.5	30.107.965	252	1
MS25-20	16 ... 20	9	30.107.966	252	1
MS25-25	20 ... 25	11 ... 12.5	30.107.967	252	1



## MOTOR PROTECTION CIRCUIT BREAKERS MST25

With overload release

AC-3 acc. to IEC/EN 60947-4-1

Type	Setting range (A)	Motor power (3-phase, 400 V) (kW)	Ordering No.	Weight (g)	Packaging (pcs)
MST25-0.4	0.25 ... 0.4	0.09	30.108.240	252	1
MST25-0.63	0.4 ... 0.63	0.12	30.108.241	252	1
MST25-1	0.63 ... 1	0.18 ... 0.25	30.108.242	252	1
MST25-1.6	1 ... 1.6	0.37 ... 0.55	30.108.243	252	1
MST25-2.5	1.6 ... 2.5	0.75 ... 1.1	30.108.244	252	1
MST25-4	2.5 ... 4	1.1 ... 1.5	30.108.245	252	1
MST25-6.3	4 ... 6.3	2.2 ... 2.5	30.108.246	252	1
MST25-10	6.3 ... 10	3 ... 4	30.108.247	252	1
MST25-16	10 ... 16	5 ... 7.5	30.108.248	252	1
MST25-20	16 ... 20	9	30.108.249	252	1
MST25-25	20 ... 25	11 ... 12.5	30.108.250	252	1



ORDERING DATA

# MOTOR PROTECTION CIRCUIT BREAKERS - MS25

## MOTOR PROTECTION CIRCUIT BREAKERS MS20

With overload and short-circuit release

AC-3 acc. to IEC/EN 60947-4-1

Type	Setting range (A)	Motor power (single-phase, 220-240 V) (kW)	Ordering No.	Weight (g)	Packaging (pcs)
MS20-0.16	0.1 ... 0.16	-	30.108.523	252	1
MS20-0.25	0.16 ... 0.25	-	30.108.524	252	1
MS20-0.4	0.25 ... 0.4	-	30.108.525	252	1
MS20-0.63	0.4 ... 0.63	-	30.108.526	252	1
MS20-1	0.63 ... 1	0.06 ... 0.09	30.108.527	252	1
MS20-1.6	1 ... 1.6	0.12	30.108.528	252	1
MS20-2.5	1.6 ... 2.5	0.18 ... 0.25	30.108.529	252	1
MS20-4	2.5 ... 4	0.37	30.108.513	252	1
MS20-6.3	4 ... 6.3	0.55 ... 0.75	30.108.514	252	1
MS20-10	6.3 ... 10	1.1 ... 1.5	30.108.515	252	1
MS20-16	10 ... 16	2.2	30.108.516	252	1
MS20-20	16 ... 20	3	30.108.517	252	1



## CIRCUIT BREAKERS FOR SINGLE-PHASE CONSUMERS MPE

With overload and short-circuit release

AC-3 acc. to IEC/EN 60947-4-1

Type	Setting range (A)	Motor power (3-phase, 400 V) (kW)	Ordering No.	Weight (g)	Packaging (pcs)
MPE	0.25	0.06	30.107.879	252	1



## CIRCUIT BREAKERS FOR SHORT-CIRCUIT PROTECTION MSZ25

With short-circuit release

Type	Setting range (A)	Motor power (3-phase, 400 V) (kW)	Ordering No.	Weight (g)	Packaging (pcs)
MSZ25-0.16	-	0.02	30.109.357	252	1
MSZ25-0.25	-	0.06	30.109.358	252	1



## CIRCUIT BREAKERS FOR TRANSFORMER PROTECTION MS25TR

With overload and short-circuit release

AC-6a acc. to IEC/EN 60947-4-1

Type	Setting range (A)	Ordering No.	Weight (g)	Packaging (pcs)
MS25TR-2.5	1.6 ... 2.5	30.109.368	252	1
MS25TR-4	2.5 ... 4	30.109.369	252	1
MS25TR-6.3	4 ... 6.3	30.109.370	252	1
MS25TR-10	6.3 ... 10	30.109.371	252	1
MS25TR-16	10 ... 16	30.109.372	252	1
MS25TR-20	16 ... 20	30.109.373	252	1
MS25TR-25	20 ... 25	30.109.374	252	1



## ORDERING DATA



### EXAMPLE:

The same switch with under-voltage release for control voltage 380 V with an auxiliary switch with two NO contacts, built in the enclosure, with an emergency stop push-button and green signal lamp for 230 V:

**MS25 - 4 / U 380 / PS 20 / O41 / NAT / SSz 230**

2

ORDERING DATA

# MOTOR PROTECTION CIRCUIT BREAKERS - ACCESSORIES

## MS25

### Auxiliary contact block for lateral mounting PS

Type	Number of contacts		Wiring diagram	Ordering No.	Weight (g)	Packaging (pcs)
	NO	NC				
PS01	0	1		38.901.670	35	1
PS10	1	0		38.901.669	35	1
PS11	1	1		38.901.501	35	1
PS20	2	0		38.901.500	35	1



2

### Under-voltage release U

Voltage (V)*	Frequency (Hz)	Ordering No.	Weight (g)	Packaging (pcs)
24	50	38.901.502	62	1
24	60	38.901.952	62	1
48	50	38.901.904	62	1
48	60	38.902.956	62	1
60	50	38.901.504	62	1
110	50	38.901.505	62	1
110	60	38.901.726	62	1
120	50	38.903.035	62	1
120	60	38.901.871	62	1
230	50	38.901.506	62	1
230	60	38.902.958	62	1
400	50	38.901.508	62	1
400	60	38.902.960	62	1
415	50	38.902.962	62	1
415	60	38.902.964	62	1
480	50	38.902.966	62	1
480	60	38.901.863	62	1
500	50	38.902.968	62	1
500	60	38.902.970	62	1
600	50	38.902.972	62	1
600	60	38.901.870	62	1



### Shunt release A

Voltage (V)*	Frequency (Hz)	Ordering No.	Weight (g)	Packaging (pcs)
24	50	38.901.510	62	1
24	60	38.901.953	62	1
48	50	38.901.905	62	1
48	60	38.902.957	62	1
110	50	38.901.513	62	1
110	60	38.901.727	62	1
120	50	38.901.973	62	1
120	60	38.901.871	62	1
230	50	38.901.514	62	1
230	60	38.902.959	62	1
400	50	38.901.516	62	1
400	60	38.902.961	62	1
415	50	38.902.963	62	1
415	60	38.902.965	62	1
480	50	38.902.967	62	1
480	60	38.901.864	62	1
500	50	38.902.969	62	1
500	60	38.902.971	62	1
600	50	38.902.973	62	1
600	60	38.901.872	62	1

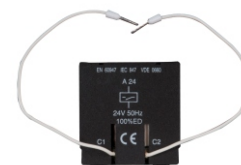

\* U and A releases for other control voltage/frequencies are on request.

ORDERING DATA

# MOTOR PROTECTION CIRCUIT BREAKERS - ACCESSORIES

## MS25

### Trip-indicating auxiliary contact block RS

Type	Number of contacts		Wiring diagram	Ordering No.	Weight (g)	Packaging (pcs)
	NO	NC				
RS01	0	1		38.902.149	35	1
RS10	1	0		38.902.150	35	1



2

- RS contact changes position from its normal state when the MS25 MPCB trips due to overload, short-circuit or the manual depression of the TEST lever.

### Adapters for connection of MS25 with a contactor

Type	Conductor length (mm)	Conductor cross-section (mm <sup>2</sup> )	Thermal current (A)	Ordering No.	Weight (g)	Packaging (pcs)
DST-U-2.5	40	2.5	20	665.200.020	12	10
DST-U-4	40	4	35	665.200.021	16	10
DST-U-2.5 L	70	2.5	20	665.200.022	14	10



### Enclosures for MS25

Type	Degree of protection	Ordering No.	Weight (g)	Packaging (pcs)
Enclosure O-41	IP41	38.422.509	222	1
Enclosure O-55	IP55	38.422.510	222	1
Front plate CP-41	IP41	38.422.035	150	1
Front plate CP-55	IP55	38.421.994	150	1



CP-41/55



O-41/55

ORDERING DATA

# MOTOR PROTECTION CIRCUIT BREAKERS - ACCESSORIES

MS25

Accessories for enclosures O-41/55 and CP-41/55

Type	Voltage	Ordering No.	Weight (g)	Packaging (pcs)
Emergency stop push-button <b>NAT</b>	/	38.901.665	40	1
Emergency stop push-button with keylock <b>NAT-K</b>	/	38.902.488	40	1
Padlocking feature <b>Z</b>	/	38.901.632	95	1
Push-button diaphragm IP55	/	38.422.130	12	1
Neutral link <b>NL</b>	/	38.552.076	525	25
Signal lamp <b>SSr</b> (Red)	250 V	623.000.131	175	25
	400 V	623.009.261		
Signal lamp <b>SSz</b> (Green)	250 V	623.009.257	175	25
	400 V	623.009.262		
Signal lamp <b>SSb</b> (Transparent)	250 V	623.009.256	175	25
	400 V	623.009.263		
Cable inlet M25 x 1.5	/	315.609.520	15	100



2

ORDERING DATA

## MS32, MS25

### Connection blocks MSS-3L

Type	Number of MPCB	Length (mm)	Ordering No.	Weight (g)	Packaging (pcs)
MSS-3L-M2-45	2	80	655.200.001	26	10
MSS-3L-M3-45	3	125	655.200.002	48	10
MSS-3L-M4-45	4	170	655.200.003	68	10
MSS-3L-M5-45	5	215	655.200.004	90	10
MSS-3L-M2 + Hi-45 + 9	2	90	655.200.005	30	10
MSS-3L-M3 + Hi-45 + 9	3	145	655.200.006	54	10
MSS-3L-M4 + Hi-45 + 9	4	200	655.200.007	78	10
MSS-3L-M5 + Hi-45 + 9	5	250	655.200.008	111	10



2

### MSS-3L-MX-45 CONNECTION BLOCKS

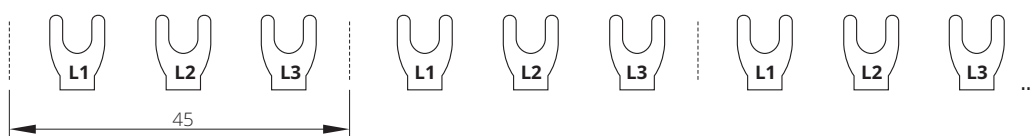

### MSS-3L-MX-45 + 9 CONNECTION BLOCKS (FOR MPCB WITH SIDE-MOUNTED ACCESSORIES)

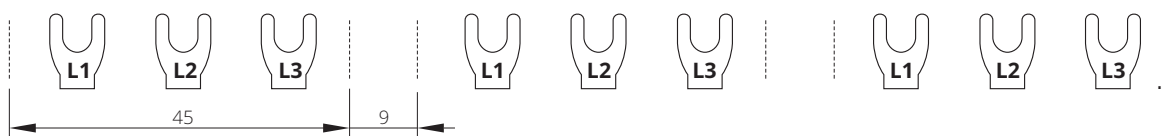

### Supply block (25 mm<sup>2</sup>)

Type	Ordering No.	Weight (g)	Packaging (pcs)
ESB-S/V-MS	655.200.009	40	10

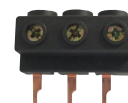

### Protection for connection cable

Type	Ordering No.	Weight (g)	Packaging (pcs)
BS-MS 0	655.200.010	2	10



ORDERING DATA

# MOTOR PROTECTION CIRCUIT BREAKERS - MS32

2

	Symbol	Unit	MS32
Type			MS32
Use			motor protection
Standards			IEC/EN 60947-2, IEC/EN 60947-4-1, IEC/EN 60204, UL 60947 CSA 22.2 No. 14
Approvals			CE, UL, CSA, EAC
Climatic class			Constant damp heat acc. to IEC 60068-2-78 Cyclic damp heat acc. to IEC 60068-2-30
Degree of protection			IP20, after terminals covering IP40
Mounting			35 mm DIN rail (EN 60715)
Mounting position			any
Ambient temperature		°C	-25 ... +60
Storage temperature		°C	-25 ... +70
Temperature range of thermal compensation		°C	-5 ... +40
Maximum altitude (MSL) *		m	2000
Mechanical endurance		op. c.	100,000
Electrical endurance		op. c.	100,000 (AC-3), 20,000 (DC-5)
Trip class acc. to IEC 60947-4-1			10
Utilization category acc. to IEC 60947-4-1			AC-3
Utilization category acc. to IEC 60947-2			A
Max. switching frequency		op. c./h	25
Shock resistance acc. to IEC 68-2-27		g	20
Vibration resistance acc. to IEC 68-2-6		g	5 (at f= 5 ... 150 Hz)
Oversvoltage category			III
Pollution degree			3
Rated insulation voltage	$U_i$	V	690
Rated impulse withstand voltage	$U_{imp}$	kV	6
Weight		g	279
Terminal capacity:			
rigid	S	mm <sup>2</sup>	1 ... 10
flexible			1 ... 6
flexible with end sleeve			0.75 ... 6
Conductor insulation stripping length		mm	10
Screw			M3
Screw type			PZ2, with self-lifting clamp protected from falling out
Tightening torque		Nm	2.0
Nominal current	$I_n$	A	0.16, 0.25, 0.4, 0.63, 1, 1.6, 2.5, 6.3, 10, 14, 18, 23, 27, 32
Current setting	$I_T$	A	0.1-0.16, 0.16-0.25, 0.25-0.4, 0.4-0.63, 0.63-1, 1-1.6, 1.6-2.5, 2.4-4, 4-6.3, 6.3-10, 9-14, 13-18, 17-23, 20-27, 25-32
Nominal current range	$I_n$	A	0.16 ... 32
Nominal frequency	f	Hz	50/60
Max. operational voltage	$U_e$	V	690
Thermal current	$I_{th}$	A	32
Max. motor current AC-3		A	32
Number of all poles			3
Number of protected poles			3
Contact gap (per pole)		mm	9.2
Release type			thermal-magnetic
Operating current of thermal overload release			$1.05 I_n < I \leq 1.2 I_n$
Operating current of magnetic release (fixed)			$12 I_n \pm 20\%$
Sensitivity to phase failure			yes
Power dissipation at $I_n$ (all poles)		W	6 ... 7.5
MTTF - Mean time to failure		h	1666
$MTTF = 1/\lambda = B10/(0.1 n_{op})$			
MTTF <sub>d</sub> - Mean time to failure dangerous		h	5000
$MTTF_d = 1/\lambda_d = B10_d/(0.1 n_{op})$			
B10 - Number of operating cycles until 10 % of devices fail		op.	20,000
B10 <sub>d</sub> - Number of operating cycles until 10 % of device dangerous		op.	60,000
$B10_d = B10/\text{ratio of dangerous failures}$			
$\lambda$ - Failure rate		1/h	$6 \times 10^{-4}$
$\lambda = (0,1 n_{op})/B10$			
$\lambda$ - Failure rate dangerous		1/h	$2 \times 10^{-4}$
$\lambda_d = (0,1 n_{op})/B10_d$			
Ratio of dangerous failures		%	33
$n_{op}$ - Operating cycles (operating cycles/h)		op./h	120

\* NOTE: Above 2000 m voltages  $U_i$  and  $U_e$  are reduced by 2% for every 100 m and current  $I_n$  by 2% for every 500 m.

TECHNICAL DATA

# MOTOR PROTECTION CIRCUIT BREAKERS - MS32

2

## Switch selection for motor protection

Standard motor powers						Setting range
Single-phase	Three-phase					
220 V 230 V 240 V	220 V 230 V 240 V	380 V 400 V 415 V	440 V	550 V	660 V 690 V	A
kW						
		0.06	0.06	0.06 ... 0.9	0.06 ... 0.12	0.1 ... 0.16
	0.06	0.09	0.12	0.09 ... 0.12	0.18	0.16 ... 0.25
	0.09	0.12 ... 0.18	0.18	0.18	0.25	0.25 ... 0.4
0.06 ... 0.09	0.09 ... 0.12	0.18 ... 0.25	0.25 ... 0.37	0.25 ... 0.37	0.37 ... 0.55	0.4 ... 0.63
0.12	0.18 ... 0.25	0.37 ... 0.55	0.37 ... 0.55	0.55 ... 0.75	0.75 ... 1.1	0.63 ... 1
0.18 ... 0.25	0.37	0.75	0.75 ... 1.1	1.1	1.5	1 ... 1.6
0.37	0.55 ... 0.75	1.1 ... 1.5	1.5	1.5 ... 2.2	2.2 ... 3	1.6 ... 2.5
0.55 ... 0.75	1.1 ... 1.5	2.2	2.2 ... 3	2.2 ... 3	4	2.5 ... 4
1.1 ... 1.5	1.5 ... 2.2	3 ... 4	4	4 ... 5.5	5.5 ... 7.5	4 ... 6.3
2.2	2.2 ... 3	5.5	5.5 ... 7.5	5.5 ... 7.5	9 ... 11	6.3 ... 10
3	4	7.5	7.5 ... 9	9 ... 11	15	9 ... 14
	5.5	9 ... 11	11	11	15	13 ... 18
	5.5 ... 7.5	11	11	15	18.5 ... 22	17 ... 23
	7.5	15	15	18.5	22	20 ... 27
						25 ... 32

MS32 motor protection switches, rated ultimate and service short-circuit breaking capacity  $I_{cu}$  and  $I_{cs}$  and max. back-up fuses if short circuit current  $I_{cp}$  exceeds  $I_{cu}$

Type	Operating current of short-circuit release (A)	Rated ultimate short-circuit breaking capacity $I_{cu}$ , $I_{cs}$ (kA)								Max. back-up fuse, if $I_{cp} > I_{cu}$ (gL) (kA)			
		230 V		400 V		500 V		690 V		230 V	400 V	500 V	690 V
		$I_{cu}$	$I_{cs}$	$I_{cu}$	$I_{cs}$	$I_{cu}$	$I_{cs}$	$I_{cu}$	$I_{cs}$				
MS32 - 0.16	2	100	100	100	100	100	100	100	100	No back-up fuse required			
MS32 - 0.25	3	100	100	100	100	100	100	100	100				
MS32 - 0.4	5	100	100	100	100	100	100	100	100				
MS32 - 0.63	8	100	100	100	100	100	100	100	100				
MS32 - 1	13	100	100	100	100	100	100	100	100				
MS32 - 1.6	22	100	100	100	100	100	100	100	100				
MS32 - 2.5	33	100	100	100	100	100	100	5	5				16
MS32 - 4	55	100	100	100	100	100	100	3	3				25
MS32 - 6.3	75	100	100	100	100	6	4.5	3	2			35	35
MS32 - 10	126	100	100	100	100	6	4.5	3	2			50	35
MS32 - 14	170	25	12.5	25	12.5	6	4.5	3	2	80	63	50	50
MS32 - 18	230	25	12.5	25	12.5	6	4.5	3	2	80	63	50	50
MS32 - 23	270	25	12.5	25	12.5	4	3	3	2	80	63	50	50
MS32 - 27	360	25	12.5	25	12.5	4	3	3	2	80	63	50	50
MS32 - 32	400	25	12.5	25	12.5	4	3	3	2	80	63	50	50

TECHNICAL DATA



## Tripping characteristics

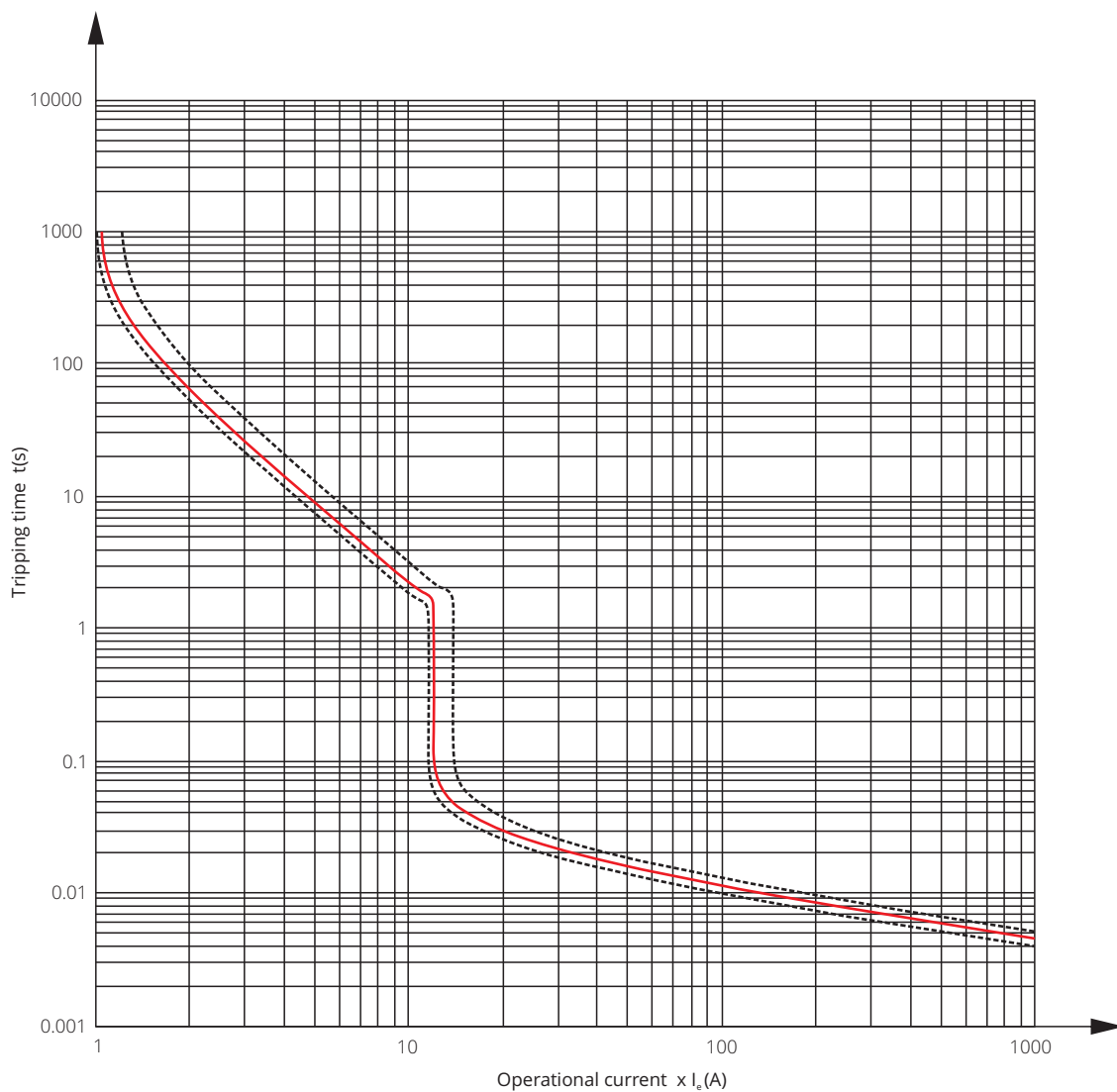

## Mounting positions of accessories

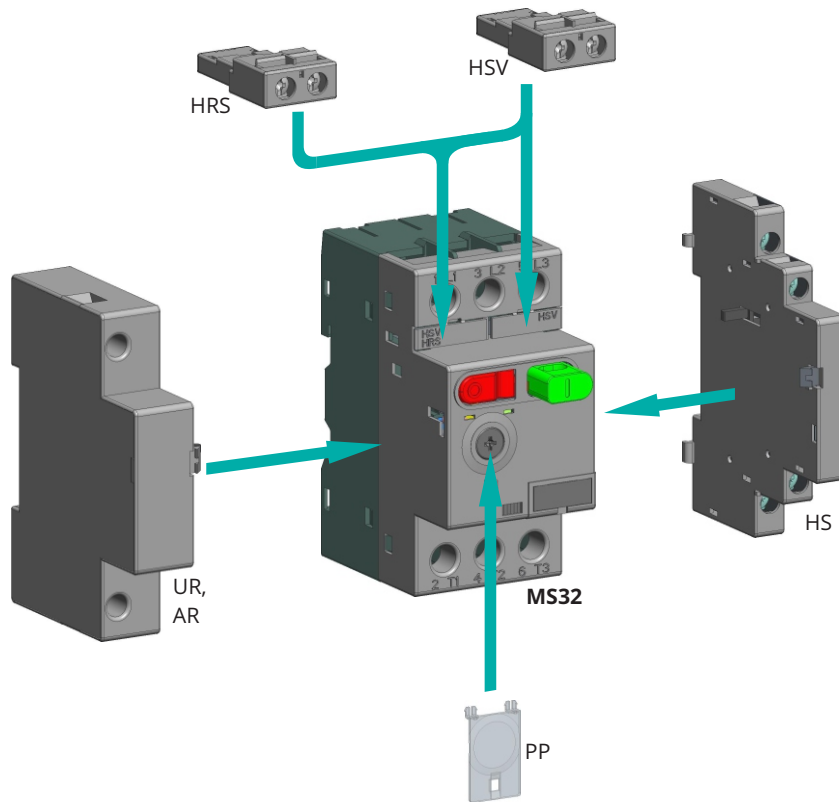

## MS32

### Auxiliary switch for side mounting HS

Type	Symbol	Unit	HS
Standards			IEC 60947-5-1, UL 60947-5-1
Approvals			CE, UL, EAC
Rated impulse voltage	$U_{imp}$	V	6 kV
Rated insulation voltage	$U_i$	V	500
Thermal current	$I_{th}$	A	5
Rated operational current AC-15 (240 V)	$I_e$	A	1.5
Rated operational current DC-13 (250 V)	$I_e$	A	0.1
Contact rating code designation for AC/DC			B300 / R300
Mechanical endurance		op. c.	100.000
Electrical endurance		op. c.	100.000
Terminal capacity	S	mm <sup>2</sup>	0.75 ... 2.5
Conductor insulation stripping length		mm	8
Screw type			M3,5
Screw head			PZ1
Tightening torque		Nm	1

### Auxiliary contact block HSV, Trip indicating contact block HRS

Type	Symbol	Unit	HRS, HSV
Standards			IEC 60947-5-1, UL 60947-5-1
Approvals			CE, UL, EAC
Rated impulse voltage	$U_{imp}$	V	6
Rated insulation voltage	$U_i$	V	300
Thermal current	$I_{th}$	A	1
Rated operational current AC-15 (240 V)	$I_e$	A	3
Rated operational current DC-13 (125 V)	$I_e$	A	0.22
Contact rating code designation for AC/DC			B300 / R300
Mechanical endurance		op. c.	100.000
Electrical endurance		op. c.	100.000
Terminal capacity	S	mm <sup>2</sup>	0.75 ... 2.5
Conductor insulation stripping length		mm	8
Screw type			M3,5
Screw head			PZ1
Tightening torque		Nm	0.6

### Under-voltage release UR, Shunt release AR

Type	Symbol	Unit	UR, AR
Standards			IEC/EN 60947-1, UL 60947-1
Approvals	$U_c$	V	CE, UL, EAC
Control voltages (AC)	$U_c$	V	24, 110, 230, 240, 400, 415, 480, 500, 600
Rated frequency	f	Hz	50/60
Pick-up voltage		$\times U_c$	< 0.85 $\leq 0.7$
Drop-out voltage			0.7 ... 0.35                      0.7 ... 0.15
Power consumption switch-on operation		VA/W	7.9 / 3.9
operation			3.3 / 0.9
Duty cycle	$t_{ON}/t_{OFF}$	%	100
Noise level		dB	$\leq 35$
Mechanical and electrical endurance		op.	min. 10.000
Terminal capacity		mm <sup>2</sup>	0.75 ... 2.5
Conductor insulation stripping length		mm	11
Screw type			M3,5
Screw head			PZ2
Tightening torque		Nm	1

# MOTOR PROTECTION CIRCUIT BREAKERS - MS25

2

		Symbol	Unit	MS25	MST25	MS20	MPE	MSZ25	MS25TR	
GENERAL	Type									
	Use			motor protection		single-phase consumer	single-phase AC motors with built-in thermal switch	short-circuit protection	transformer protection	
	Standards			IEC/EN 60947-4-1, IEC/EN 60947-2, IEC/EN 60204, UL 60947, CSA 22.2 No. 14		IEC/EN 60947-2, IEC/EN 60947-4-1	IEC/EN 60947-2, IEC/EN 60947-4-1	IEC/EN 60947-2	IEC/EN 60947-2	
	Approvals			CE, UL, EAC		CE, EAC	CE	CE	CE	
	Climatic class			Constant damp heat acc. to IEC 60068-2-78 Cyclic damp heat acc. to IEC 60068-2-30						
	Degree of protection			IP20, after terminals covering IP40						
	Mounting			35 mm DIN rail (EN 60715)						
	Mounting position			any						
	Ambient temperature		°C	-25 ... +60						
	Storage temperature		°C	-25 ... +70						
	Temperature range of thermal compensation		°C	-5 ... +40						
	Maximum altitude (MSL) *		m	2000						
	Mechanical endurance		op. c.	100.000						
	Electrical endurance		op. c.	100.000 (AC-3), 20.000 (DC-5)			100.000 (AC-3)		100.000 (AC-3), 20.000 (DC-5)	
	Trip class acc. to IEC 60947-4-1			10A	10A	10A	10A	/	10A	
	Utilization category acc. to IEC 60947-4-1			AC-3, DC-5	AC-3, DC-5	AC-3, DC-5	AC-3	AC-3, DC-5	AC-3, DC-5	
	Utilization category acc. to IEC 60947-2			A						
	Max. switching frequency		op. c./h	25						
	Shock resistance acc. to IEC 68-2-27		g	20						
	Vibration resistance acc. to IEC 68-2-6		g	5 (at f= 5 ... 150 Hz)						
	Overvoltage category			III						
	Pollution degree			3						
	Rated insulation voltage	$U_i$	V	690	400	690	250	400	690	
	Rated impulse withstand voltage	$U_{imp}$	kV	6						
	Weight		g	252						
MAIN CIRCUIT	Terminal capacity:									
	rigid	S	mm <sup>2</sup>	1 ... 6						
	flexible			1 ... 4						
	flexible with end sleeve			0.75 ... 4						
	Conductor insulation stripping length		mm	10						
	Screw			M3						
	Screw type			PZ2, with self-lifting clamp protected from falling out						
	Tightening torque		Nm	1,8						
	Nominal current	$I_n$	A	0,16, 0,25, 0,4, 0,63, 1, 1,6, 2,5, 4, 6,3, 10, 16, 20, 25	0,4, 0,63, 1, 1,6, 2,5, 4, 6,3, 10, 16, 20, 25	0,16, 0,25, 0,4, 0,63, 1, 1,6, 2,5, 4, 6,3, 10, 16, 20, 25		0,4 ... 10	0,16, 0,25	2,5, 4, 6,3, 10, 16, 20, 25
	Current setting	$I_T$	A	0,1-0,16, 0,16-0,25, 0,25-0,4, 0,4-0,63, 0,63-1, 1-1,6, 1,6-2,5, 2,5-4, 4-6,3, 6,3-10, 10-16, 16-20, 20-25	0,25-0,4, 0,4-0,63, 0,63-1, 1-1,6, 1,6-2,5, 2,5-4, 4-6,3, 6,3-10, 10-16, 16-20, 20-25	0,1-0,16, 0,16-0,25, 0,25-0,4, 0,4-0,63, 0,63-1, 1-1,6, 1,6-2,5, 2,5-4, 4-6,3, 6,3-10, 10-16, 16-20, 20-25		fixed	fixed	2,5, 4, 6,3, 6,3-10, 10-16, 16, 20, 20-25
	Nominal current range	$I_n$	A	0,16 ... 25	0,4 ... 25	0,16 ... 20		0,4 ... 10	0,16 ... 0,25	2,5 ... 25
	Nominal frequency	f	Hz	50/60						
	Max. operational voltage	$U_e$	V	690	400	690	250	400	690	
	Thermal current	$I_{th}$	A	25**	25**	20**	10	0,25	25	
	Max. motor current AC-3		A	25	25	20	/	/	/	
	Max. motor current DC-5 (max. 250 V DC, all poles in series)		A	25	25	20	0,25	0,25	25	
	Number of all poles			3	3	1	1	3	3	
	Number of protected poles			3	3	1	1	3	3	
	Contact gap (per pole)		mm	9,5						
	Release type			thermal-magnetic	thermal	thermal-magnetic	thermal-magnetic	thermal	thermal-magnetic	
Operating current of thermal overload release			$1,05 I_n < I \leq 1,2 I_n$	$1,05 I_n < I \leq 1,2 I_n$	$1,05 I_n < I \leq 1,2 I_n$	/	/	$1,05 I_n < I \leq 1,2 I_n$		
Operating current of magnetic release (fixed)			$12 I_n \pm 20 \%$	$12 I_n \pm 20 \%$	$12 I_n \pm 20 \%$	$12 I_n \pm 20 \%$	$12 I_n \pm 20 \%$	$17 I_n \pm 20 \%$		
Sensitivity to phase failure			yes	yes	/	/	/	yes		
Power dissipation at $I_n$ (all poles)		W	6 ... 7,5	6 ... 7,5	4 ... 5	2 ... 2,5	≈ 0,5	6 ... 7,5		

**NOTE:**

\* Above 2000 m voltages  $U_i$  and  $U_e$  are reduced by 2% for every 100 m and current  $I_n$  by 2% for every 500 m.

\*\* Maximum number of MPCBs mounted close together: 3

TECHNICAL DATA

# MOTOR PROTECTION CIRCUIT BREAKERS - MS25

2

SAFETY	Type	Symbol	Unit	MS25	MST25	MS20	MPE	MSZ25	MS25TR	
	MTTF - Mean time to failure $MTTF = 1/\lambda = B10/(0.1 n_{op})$		h				1666			
	MTTF <sub>d</sub> - Mean time to failure dangerous $MTTF_d = 1/\lambda_d = B10_d/(0.1 n_{op})$		h				5000			
	B10 - Number of operating cycles until 10 % of devices fail		op.				20.000			
	B10 <sub>d</sub> - Number of operating cycles until 10 % of device dangerous $B10_d = B10/\text{ratio of dangerous failures}$		op.				60.000			
	$\lambda$ - Failure rate $\lambda = (0,1 n_{op})/B10$		1/h				$6 \times 10^{-4}$			
	$\lambda$ - Failure rate dangerous $\lambda_d = (0,1 n_{op})/B10_d$		1/h				$2 \times 10^{-4}$			
	Ratio of dangerous failures		%				33			
	$n_{op}$ - Operating cycles (operating cycles/h)		op./h				120			

## Switch selection for motor protection

Standard motor powers						Setting range
Single-phase	Three-phase					
220 V 230 V 240 V	220 V 230 V 240 V	380 V 400 V	440 V	550 V	660 V 690 V	A
kW						
		0.02			0.06	0.1 ... 0.16
		0.06	0.06	0.06	0.09	0.16 ... 0.25
	0.06	0.09	0.12	0.12	0.18	0.25 ... 0.4
	0.09	0.12	0.18	0.25	0.25	0.4 ... 0.63
0.06 ... 0.09	0.09 ... 0.12	0.18 ... 0.25	0.25	0.37	0.37 ... 0.55	0.63 ... 1
0.12	0.18 ... 0.25	0.37 ... 0.55	0.37 ... 0.55	0.55 ... 0.8	0.75 ... 1.1	1 ... 1.6
0.18 ... 0.25	0.37	0.75 ... 1.1	0.75 ... 1.1	1.1	1.5	1.6 ... 2.5
0.37	0.55 ... 0.75	1.1 ... 1.5	1.5	1.5 ... 2.2	2.2 ... 3	2.5 ... 4
0.55 ... 0.75	1.1 ... 1.5	2.2 ... 2.5	2.2 ... 3	3	4	4 ... 6.3
1.1 ... 1.5	1.5 ... 2.5	3 ... 4	4 ... 5	4 ... 5.5	5.5 ... 7.5	6.3 ... 10
2.2	3 ... 4	5 ... 7.5	5.5 ... 9	7.5 ... 9	11	10 ... 16
3	5.5	9	11	11 ... 12.5	15	16 ... 20
	5.5 ... 7.5	11 ... 12.5	12.5	15	18.5	20 ... 25

MS25 motor protection switches, rated ultimate and service short-circuit breaking capacity  $I_{cu}$  and  $I_{cs}$  and max. back-up fuses if short circuit current  $I_{cp}$  exceeds  $I_{cu}$

Type	Operating current of short-circuit release (A)	Rated ultimate short-circuit breaking capacity $I_{cu}$ , $I_{cs}$ (kA)				Max. back-up fuse, if $I_{cp} > I_{cu}$ (gL) (kA)			
		230 V $I_{cu}$	400 V $I_{cu}$	500 V $I_{cu}$	690 V $I_{cu}$	230 V	400 V	500 V	690 V
MS25 - 0.16	2	50	50	50	50	No back-up fuse required			
MS25 - 0.25	3	50	50	50	50				
MS25 - 0.4	5	50	50	50	50				
MS25 - 0.63	8	50	50	50	50				
MS25 - 1	13	50	50	50	50				
MS25 - 1.6	22	50	50	50	50				
MS25 - 2.5	33	50	50	3	2.5			25	20
MS25 - 4	55	50	50	3	2.5			35	25
MS25 - 6.3	84	50	50	3	2.5			50	35
MS25 - 10	126	50	6	3	2.5		80	50	35
MS25 - 16	170	6	4	2.5	2	80	80	63	35
MS25 - 20	230	6	4	2.5	2	80	80	63	50
MS25 - 25	270	6	4	2.5	2	80	80	63	50

TECHNICAL DATA

## Tripping characteristics

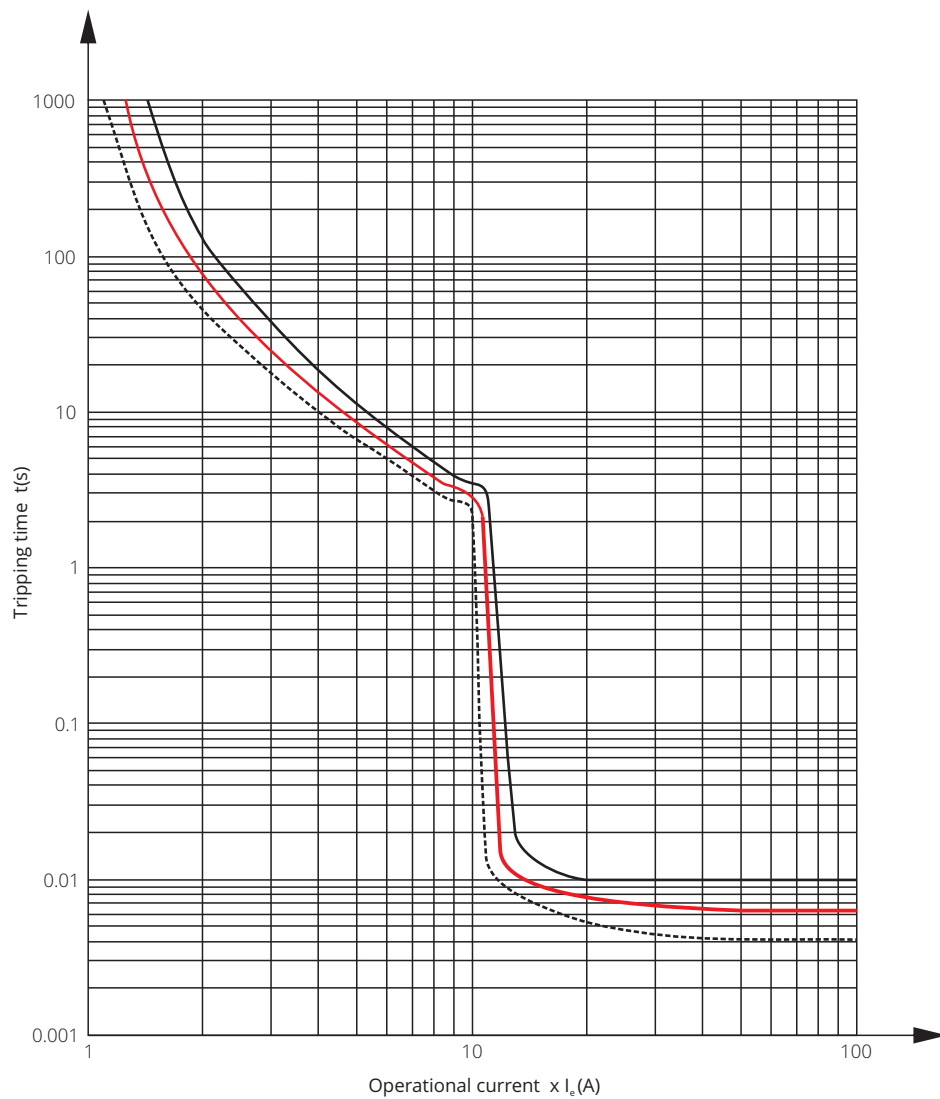

## Mounting positions of accessories

2

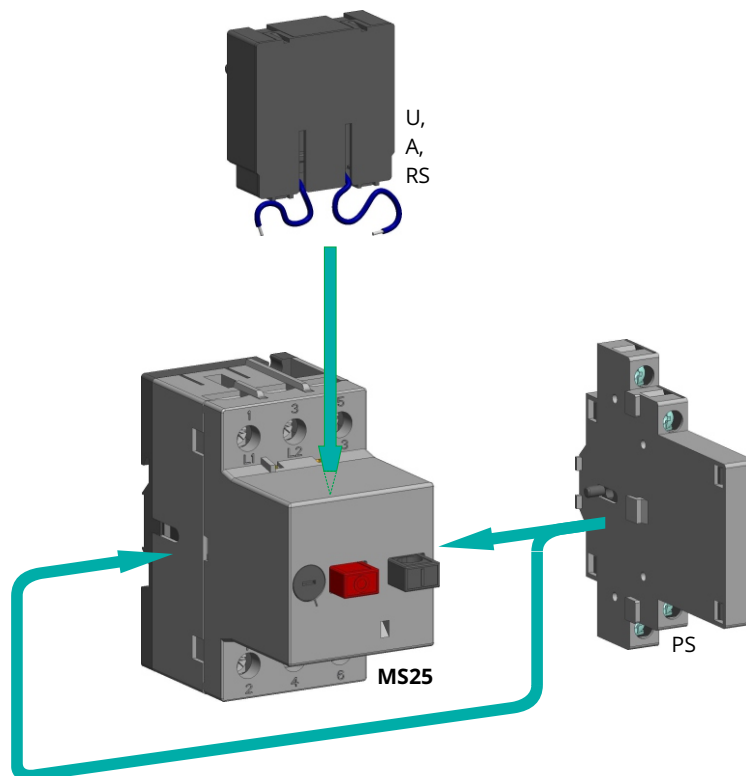

## MS25

### Auxiliary switch for lateral mounting PS

Type	Symbol	Unit	PS
Standards			IEC 60947-5-1, UL 60947-5-1
Approvals			CE, UL, EAC
Rated impulse voltage	$U_{imp}$	kV	6
Rated insulation voltage	$U_i$	V	500
Thermal current	$I_{th}$	A	6
Rated operational current AC-15			
230 V	$I_e$	A	3.5
400 V			2
500 V			1.5
Mechanical endurance		op. c.	100.000
Terminal capacity	S	mm <sup>2</sup>	0.75 ... 2.5
Conductor insulation stripping length		mm	8
Screw type			M3.5
Screw head			PZ1
Tightening torque		Nm	1

### Trip-indicating auxiliary switch RS

Type	Symbol	Unit	RS
Standards			IEC 60947-5-1, UL 60947-5-1
Approvals			CE, UL, EAC
Rated impulse voltage	$U_{imp}$	kV	6
Rated insulation voltage	$U_i$	V	500
Thermal current	$I_{th}$	A	6
Rated operational current AC-15			
230 V	$I_e$	A	3.5
400 V			2
500 V			1.5
Mechanical endurance		op. c.	100.000

### Under-voltage release U, Shunt release A

Type	Symbol	Unit	U, A
Standard			IEC 60947-5-1, UL 60947-5-1
Approvals			CE, UL, EAC
Control voltages (AC)	$U_c$	V	24, 48, 110, 120, 230, 400, 415, 480, 500, 600
Rated frequency	f	Hz	50/60
Pick-up voltage		x $U_c$	≤ 0.85
Drop-out voltage			0.7 ... 0.35
Power consumption switch-on operation		VA/W	7.5 / 4.3
operation			3.8 / 1.3
Duty cycle	$t_{ON}/t_{OFF}$	%	100
Noise level		dB	≤ 35
Mechanical and electrical endurance		op. c.	100.000



# MOTOR PROTECTION CIRCUIT BREAKERS - MS32

MS32

Auxiliary switch HS

Under-voltage release UR  
Shunt release AR

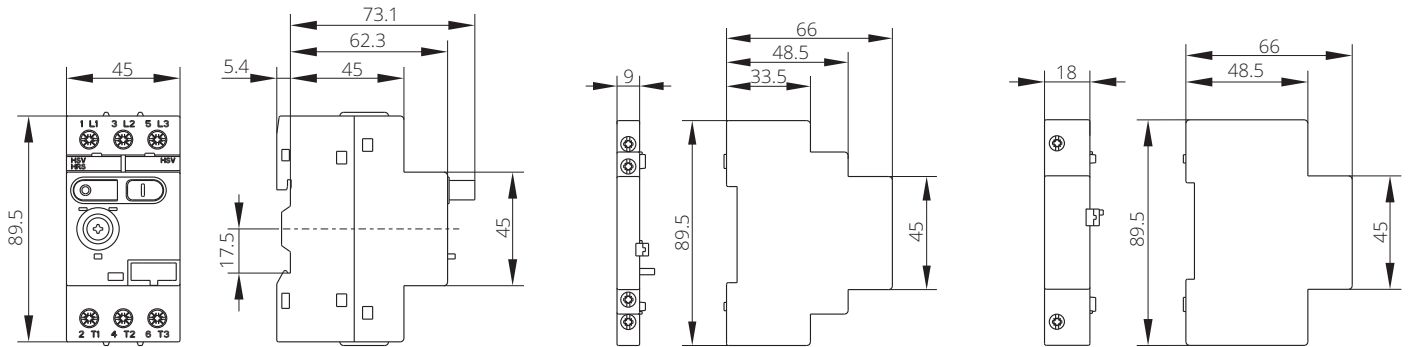

FP-41/55

HO-41/55

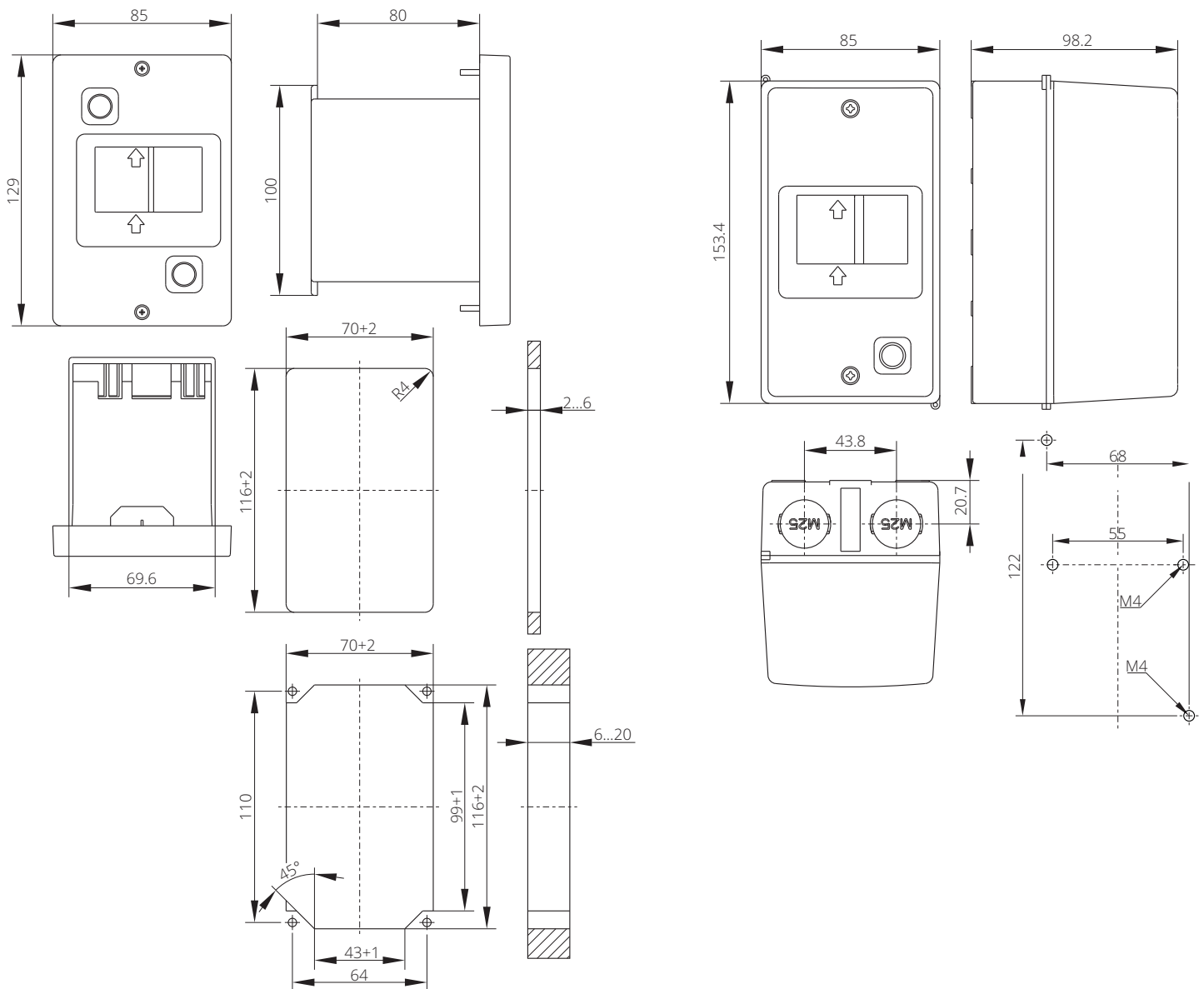

DIMENSIONS

# MOTOR PROTECTION CIRCUIT BREAKERS - MS25

MS25

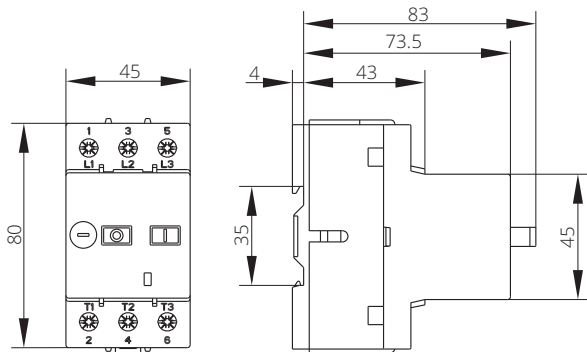

Auxiliary switch PS

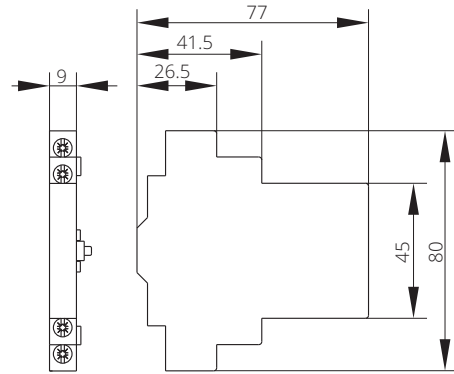

2

O-41/55

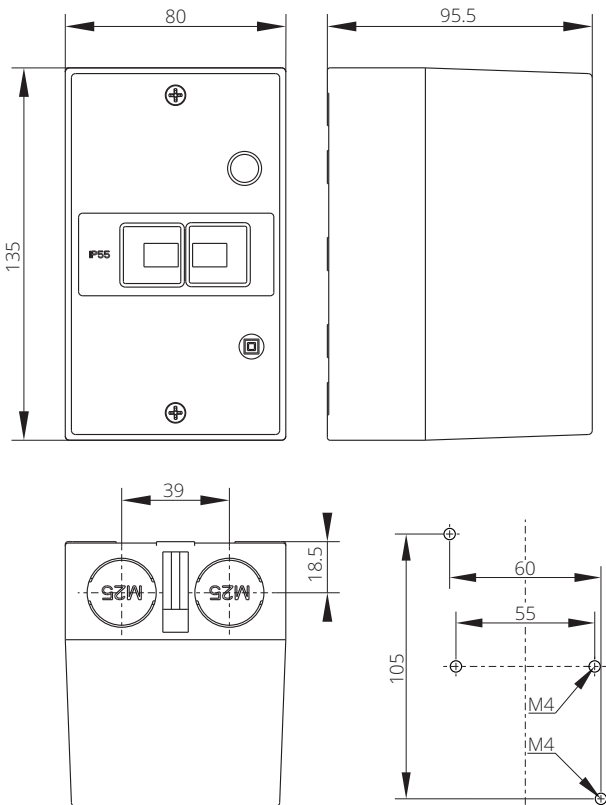

CP-41/55

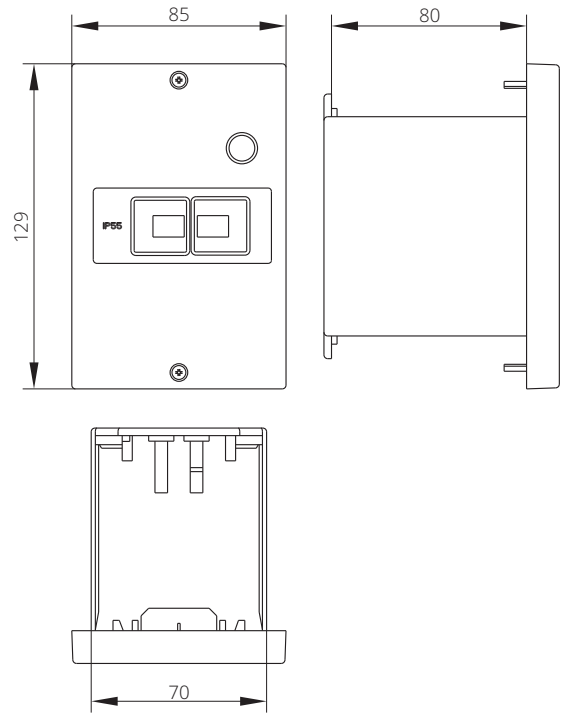

DIMENSIONS