

## RADIO INTERFERENCE SUPPRESSION CAPACITORS AND FILTERS

### COMPONENTS FOR RADIO-INTERFERENCE SUPPRESSION

- **RELEVANT FOR** ELECTRONIC, AUDIO AND VIDEO DEVICES, CHARGERS, MEASUREMENT INSTRUMENTS, ELECTRICAL HAND TOOLS, ELECTRICAL HOME APPLIANCES AND MACHINES

### FILTERS FOR RADIO-INTERFERENCE SUPPRESSION

- **RELEVANT FOR** HOME APPLIANCES, ELECTRICAL HAND TOOLS AND DC ELECTROMOTORS

## GENERAL INFORMATION ON ISKRA CAPACITORS FOR RADIO INTERFERENCE SUPPRESSION COMPONENTS

### ■ GENERAL INFORMATION

3

## RADIO INTERFERENCE SUPPRESSION COMPONENTS

TYPE	RATED VOLTAGE	CLASS	CONSTRUCTION OF CAPACITORS	PAGE
■ <b>KNB153x</b>	275 V AC, 300 V AC	<b>X2</b>	METALLIZED POLYPROPYLENE FILM CAPACITOR	12
■ <b>KNB156x</b>	275 V AC, 300 V AC	<b>X2</b>	METALLIZED POLYPROPYLENE FILM CAPACITOR	17
■ <b>KNB158x</b>	305 V AC, 310 V AC	<b>X2</b>	METALLIZED POLYPROPYLENE FILM CAPACITOR	26
■ <b>KNR153x</b>	275 V AC	<b>X2</b>	METALLIZED POLYPROPYLENE FILM CAPACITOR WITH RESISTOR (RC UNIT)	28
■ <b>KNB252x</b>	275 V AC, 300 V AC	<b>Y2</b>	METALLIZED POLYPROPYLENE FILM CAPACITOR	30
■ <b>KNB253x</b>	440 V AC	<b>Y1</b>	METALLIZED POLYPROPYLENE FILM CAPACITOR	32
■ <b>KNB154x</b>	440 V AC	<b>X1</b>	METALLIZED POLYPROPYLENE FILM CAPACITOR	34
■ <b>KNB155x</b>	310 V AC	<b>X1</b>	METALLIZED POLYPROPYLENE FILM CAPACITOR	36
■ <b>KNB753x</b>	275 V AC	<b>X2Y2</b>	METALLIZED POLYPROPYLENE FILM CAPACITOR	38
■ <b>KPB23xx</b>	275 V AC	<b>X1</b>	IMPREGNATED PAPER CAPACITOR	39
■ <b>KPR23xx</b>	275 V AC	<b>X1</b>	IMPREGNATED PAPER CAPACITOR WITH RESISITOR (RC UNIT)	40
■ <b>KPB53xx</b>	275 V AC	<b>Y2</b>	IMPREGNATED PAPER CAPACITOR	41
■ <b>KPB70xx</b>	250 V AC, 275 V AC	<b>X1Y2</b>	IMPREGNATED PAPER CAPACITOR	42
■ <b>KPB7077</b>	275 V AC	<b>X1Y2</b>	IMPREGNATED PAPER CAPACITOR	43
■ <b>KPB73xx</b>	250 V AC, 275 V AC	<b>X1Y2</b>	IMPREGNATED PAPER CAPACITOR	44
■ <b>KPB7325</b>	275 V AC	<b>X1Y2</b>	IMPREGNATED PAPER CAPACITOR	46
■ <b>KPB7341</b>	275 V AC	<b>X1Y2</b>	IMPREGNATED PAPER CAPACITOR	47
■ <b>KPB7426</b>	275 V AC	<b>X1Y2</b>	IMPREGNATED PAPER CAPACITOR	48
■ <b>KNB7425</b>	275 V AC	<b>X1Y2</b>	METALLIZED POLYPROPYLENE FILM CAPACITOR	49
■ <b>KPB83xx</b>	275 V AC	<b>X1Y2</b>	IMPREGNATED PAPER CAPACITOR	50
■ <b>KPL3008</b>	275 V AC	<b>X1Y2</b>	IMPREGNATED PAPER CAPACITOR (LC FILTER)	51
■ <b>KPL3009</b>	275 V AC	<b>X1Y2</b>	IMPREGNATED PAPER CAPACITOR (LC FILTER)	53
■ <b>KPL3023</b>	275 V AC	<b>X1Y2</b>	IMPREGNATED PAPER CAPACITOR (LC FILTER)	55
■ <b>KPL3024</b>	275 V AC	<b>X1Y2</b>	IMPREGNATED PAPER CAPACITOR (LC FILTER)	57
■ <b>KPL3508</b>	275 V AC	<b>X1Y2</b>	IMPREGNATED PAPER CAPACITOR (LC FILTER)	59
■ <b>KPL3523</b>	250 V AC, 275 V AC	<b>X1Y2</b>	IMPREGNATED PAPER CAPACITOR (LC FILTER)	62
■ <b>KPL3524</b>	250 V AC, 275 V AC	<b>X1Y2</b>	IMPREGNATED PAPER CAPACITOR (LC FILTER)	65
■ <b>KPL3300</b>	250 V AC, 275 V AC	<b>X1Y2</b>	IMPREGNATED PAPER CAPACITOR (LC FILTER)	68
■ <b>KNL3524</b>	250 V AC	<b>X1Y2</b>	METALLIZED POLYPROPYLENE FILM CAPACITOR (LC FILTER)	69

## ORIGIN AND SPREADING OF INTERFERENCE

THERE ARE TWO MAIN SOURCES OF RADIO INTERFERENCE:

- DEVICES, WHICH DUE TO THEIR CONSTRUCTION PRODUCE RF ENERGY. THESE INCLUDE GENERATORS FOR USE IN INDUSTRY, MEDICINE AND SCIENCE, AS WELL AS OSCILLATORS, RADIO AND TV RECEIVERS ETC.
- DEVICES, WHICH PRODUCE A WIDE SPECTRUM OF FREQUENCIES DUE TO RAPID VARIATIONS IN ELECTRICAL CURRENT INTENSITY. THESE INCLUDE DEVICES WITH SWITCHING COMPONENTS, THYRISTORS, TRIACS, COMMUTATORS AND SIMILAR.

INTERFERENCE FROM SOURCE TO RECEIVER IS SPREAD IN THREE WAYS: ALONG CONDUCTORS, BY COUPLING AND BY RADIATION. TO FREQUENCIES OF 30 MHz APPROXIMATELY, INTERFERENCE IS SPREAD MAINLY ALONG THE INSTALLED ELECTRICAL CONDUCTORS. IN THIS RANGE INDUCTIVE AND CAPACITIVE COUPLING ALSO OCCURS BETWEEN THE CONDUCTORS AND OTHER METAL PARTS OF THE DEVICES ACTING AS SUPPORTS OF INTERFERENCE TRANSFER.

FREQUENCIES HIGHER THAN 30 MHz ARE SPREAD BY RADIATION SINCE INTERFERENCE SOURCE DIMENSIONS AND TERMINAL CONDUCTORS ARE IN ORDER OF SIZE TO THE WAVE LENGTH OF THE RADIATED INTERFERENCE. THE METAL PARTS THEREFORE, ACT AS ANTENNAS.

THE DEVICE CONNECTED TO THE MAINS SUPPLY PRODUCES TWO KINDS OF INTERFERENCE CURRENTS, RUNNING ALONG CONDUCTORS AS SEEN IN FIGURE 1.

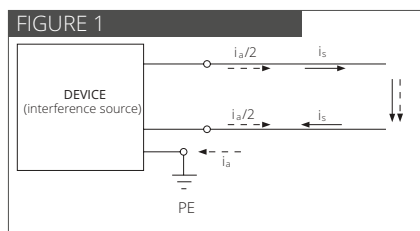

SYMMETRICAL INTERFERENCE CURRENT RUNS IN DIFFERENT DIRECTIONS IN THE PHASE AND NEUTRAL CONDUCTORS.

ASYMMETRICAL CURRENT RUNS IN THE SAME DIRECTION IN BOTH CONDUCTORS AND ENDS IN THE DEVICE VIA THE EARTHING CONNECTION. AN EARTHING CONNECTION CAN EITHER BE AN EARTHING CONDUCTOR OR CAPACITANCE BETWEEN THE DEVICE AND THE SURROUNDING. INTERFERENCE ON LONG OR MEDIUM RADIO WAVES IS GENERALLY GREATER IF THE DEVICE IS EARTHED. IN THIS CASE IMPEDANCE TO THE SURROUNDING IS SHORT CIRCUITED AND THE ASYMMETRICAL INTERFERENCE CURRENT INCREASES.

TWO TYPES OF INTERFERENCE APPEAR ACCORDING TO DURATION TIME; CONTINUOUS INTERFERENCE AND DISCONTINUOUS INTERFERENCE. THE LATTER OCCURS AS IMPULSES WITH LESS EFFECT THAN CONTINUOUS INTERFERENCE. THEY ARE TREATED AND SUPPRESSED FROM CONTINUOUS INTERFERENCE SEPARATELY. EXACT DEFINITIONS ARE GIVEN IN THE REGULATIONS E.G. CISPR PUBL.11, CISPR PUBL.14, EN 55011; EN 55014.

# GENERAL INFORMATION

## MAXIMUM PERMITTED INTERFERENCE LIMITS

IN ORDER TO GUARANTEE GOOD OPERATION OF COMMUNICATIONAL AND OTHER EQUIPMENT, RADIO INTERFERENCE MUST BE TOLERABLY LIMITED. INTERFERENCE PRODUCED FROM THE SOURCE ARE MEASURED AS FOLLOWS:

- UP TO FREQUENCY 30 MHZ, INTERFERENCE VOLTAGES ARE MEASURED WHICH SPREAD ALONG THE TERMINAL IN THE SUPPLY NETWORK,
- ABOVE 30 MHZ, STRENGTH OF RADIATED FIELD OR RADIATED POWER ON THE TERMINAL IN THE SUPPLY NETWORK IS MEASURED.

PERMITTED LEVELS OF INTERFERENCE ARE GIVEN IN THE NATIONAL AND INTERNATIONAL REGULATIONS. RECOMMENDATIONS GIVEN BY CISPR (COMITE INTERNATIONAL SPECIAL DE PERTURBATION RADIOELECTRIQUES) ARE AS FOLLOWS: CISPR PUBL.11, CISPR PUBL.14, EN 55011; EN 55014; ETC.

OPERATIONAL METHODS DURING MEASUREMENT ARE PRESCRIBED WITH INDIVIDUAL STIPULATIONS AND ARE GIVEN IN THE RECOMMENDATIONS OF THE CISPR PUBL. 14.

## THE INTERFERENCE SUPPRESSION

TWO METHODS:

- REDUCING INTERFERENCE ORIGIN,
- TAKING STEPS TO PREVENT INTERFERENCE FROM SPREADING FROM THE DEVICE OF ORIGIN.

SPREADING OF INTERFERENCE IS GENERALLY SUPPRESSED BY SUPPRESSION COMPONENTS CONNECTED TO THE TERMINAL OF THE POWER SOURCE OF THE DEVICE (NETWORK, BATTERY ...) AND IN CERTAIN CASES, ON THE SOURCE OF INTERFERENCE ON THE DEVICE (BRUSHES OF THE MOTOR, SWITCHES, RELAYS ...) OR BY SHIELDING THE DEVICE.

AS SUPPRESSION COMPONENTS USE IS MADE OF CAPACITORS, CHOKES, FILTER SETS CONSISTING OF CAPACITORS, CHOKES AND RESISTORS.

## CAPACITORS AND FILTERS FOR RADIO INTERFERENCE SUPPRESSION

REQUIREMENTS FOR CAPACITORS AND FILTERS FOR RADIO INTERFERENCE SUPPRESSION ARE GIVEN IN NATIONAL AND INTERNATIONAL STANDARDS:

- IEC 60384-14
- UL 60384-14
- CSA 60384-14

## DEFINITIONS TAKEN FROM STANDARDS

### CLASS X CAPACITORS

CLASS X CAPACITORS ARE SUITABLE FOR APPLICATIONS WHERE THERE IS NO DANGER OF ELECTRICAL SHOCK IN CASE OF BREAKDOWN. CLASS X CAPACITORS ARE DIVIDED INTO TWO SUBCLASSES (SEE TABLE 1) ACCORDING TO THE PEAK VOLTAGES OF THE PULSES TO WHICH THEY ARE EXPOSED DURING OPERATION IN ADDITION TO THE LINE VOLTAGE. SUCH IMPULSES CAN BE CAUSED BY LIGHTNING IN OVERHEAD LINES, SWITCHING OPERATIONS IN NEIGHBOURING EQUIPMENT OR IN THE EQUIPMENT WHICH IS SHIELDED BY THE CAPACITOR.

TABLE 1

SUB-CLASS	PEAK PULSE VOLTAGE IN SERVICE	APPLICATION	PEAK VALUE OF THE URGE VOLTAGE TO BE ADDED BEFORE ENDURANCE TEST
<b>X1</b>	> 2.5 kV ≤ 4.0 kV	USE WITH HIGH PEAK-VOLTAGES	FOR $C_R \leq 1.0 \mu\text{F}$ : $U_p = 4.0 \text{ kV}$ FOR $C_R > 1.0 \mu\text{F}$ : $U_p = (4/\sqrt{C_R}) \text{ kV}$
<b>X2</b>	≤ 2.5 kV	GENERAL REQUIREMENTS	FOR $C_R \leq 1.0 \mu\text{F}$ : $U_p = 2.5 \text{ kV}$ FOR $C_R > 1.0 \mu\text{F}$ : $U_p = (2.5/\sqrt{C_R}) \text{ kV}$

### CLASS Y CAPACITORS

CLASS Y CAPACITORS ARE SUITABLE FOR APPLICATIONS WHERE THE BREAKDOWN OF THE CAPACITOR CAN LEAD TO A DANGEROUS ELECTRIC SHOCK. CLASS Y CAPACITORS ARE SUBDIVIDED INTO THREE SUBCLASSES Y1, Y2, Y4 SHOWN IN TABLE 2:

TABLE 2

SUB-CLASS	TYPE OF THE BY-PASS INSULATION	RATED VOLTAGE RANGE	PEAK IMPULSE VOLTAGE BEFORE ENDURANCE TEST
<b>Y1</b>	DOUBLE OR REINFORCED INSULATION	≤ 500 V	8.0 kV
<b>Y2</b>	BASIC OR SUPPLEMENTARY INSULATION	≥ 150 V ≤ 300 V	5.0 kV
<b>Y4</b>	BASIC OR SUPPLEMENTARY INSULATION	< 150 V	2.5 kV

#### NOTE:

THE INCREASED ELECTRICAL AND MECHANICAL SAFETY IS SUPPOSED TO RULE OUT SHORT CIRCUITS IN THE CAPACITOR; THE CURRENT FLOWING THROUGH THE CAPACITOR WHEN USING ALTERNATING VOLTAGE AND THE ENERGY CONTENT OF THE CAPACITOR WHEN USING DIRECT VOLTAGE, IS SUPPOSED TO BE REDUCED TO A SAFE LEVEL BY LIMITING THE CAPACITY.

Y CAPACITORS, BY FULFILLING THEIR TECHNICAL PURPOSE IN ELECTRICAL EQUIPMENT, MACHINES AND INSTALLATIONS, BRIDGE OVER THE PLANT/INDUSTRIAL INSULATION WHOSE SAFETY TOGETHER WITH ADDITIONAL PRECAUTIONARY MEASURES WILL AVERT DANGERS FOR HUMANS AND ANIMALS.

## BIPOLAR CAPACITORS

A CAPACITOR WITH 2 CONNECTIONS FOR SUPPRESSION OF ELECTROMAGNETIC INTERFERENCE, SEE FIG. 2.

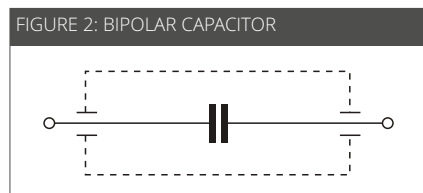

## RC COMBINATION

AN RC COMBINATION IN SERIES MOUNTING IS A FUNCTIONAL UNIT OF CLASS X OR Y, RESISTOR AND CAPACITOR MOUNTED IN SERIES, SEE FIG. 3.

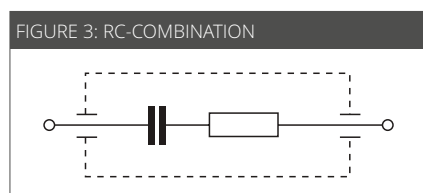

## FOUR-POLAR CAPACITORS

FOUR-POLAR CAPACITORS (FEED THROUGH CAPACITORS/NON-COAXIAL) HAVE, FOR AT LEAST ONE COATING, TWO ELECTROMAGNETICALLY MOSTLY DE-COUPLED FEEDING LINES WHICH SUPPLY THE ELECTRICAL CURRENT.

THE ACTIVE CURRENT EITHER FLOWS THROUGH THE ELECTRODES OR IS CONDUCTED AROUND THEM.

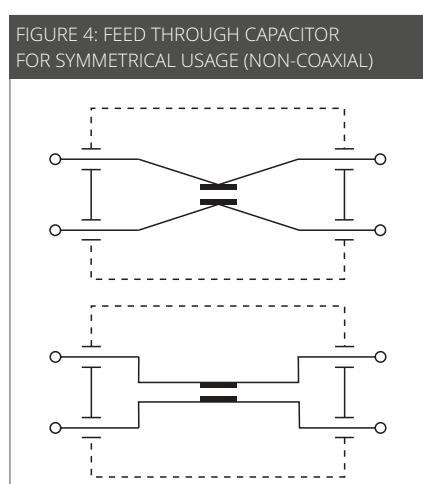

# GENERAL INFORMATION

## BYPASS CAPACITORS

BYPASS CAPACITORS BRANCH OFF HIGH FREQUENCY CURRENTS. THERE ARE THREE MODELS IN USE:

- SINGLE,
- DELTA,
- T-CONTROLS.

THE SINGLE CAPACITOR CONSISTS OF A CAPACITOR IN A METAL HOUSING TO WHICH A CONNECTION IS FASTENED ACCORDING TO FIG. 5A.

THE DELTA CONSTRUCTION CONSISTS OF ONE X-, AND TWO Y2 CAPACITORS WHICH ARE CONNECTED IN A TRIANGLE AS IN FIG. 5B.

THE T CONSTRUCTION CONSISTS OF THREE CAPACITORS C A, C B AND C C - CONNECTED IN T-SHAPE AS IN FIG. 5C.

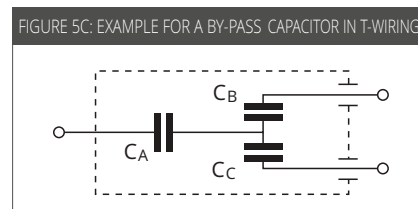
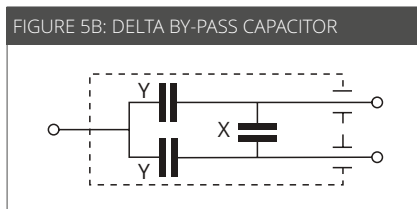
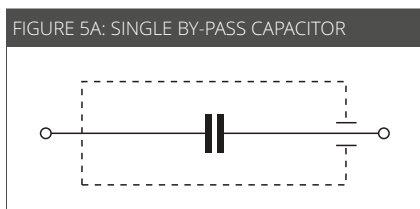

## RATED VOLTAGE

THE RATED VOLTAGE IS EITHER THE RMS-VALUE OF THE OPERATING VOLTAGE AT RATED FREQUENCY OR THE OPERATING DIRECT CURRENT VOLTAGE WHICH IS ALLOWED BETWEEN THE CONNECTIONS OF THE CAPACITOR IN THE TOTAL TEMPERATURE RANGE BETWEEN THE UPPER AND LOWER CATEGORY TEMPERATURES.

### NOTE:

THE RATED VOLTAGE OF RADIO INTERFERENCE SUPPRESSION CAPACITORS IS GENERALLY CHOSEN AS EQUAL TO OR GREATER THAN THE RATED VOLTAGE OF THE NETWORK WHICH IS USED. IT HAS TO BE TAKEN INTO ACCOUNT THAT THE VOLTAGE OF THE NETWORK MAY TEMPORARILY BE AS MUCH AS 10 % ABOVE THE RATED VOLTAGE.

## RATED FREQUENCY

THE RATED FREQUENCY IS THE RATED SUPPLY FREQUENCY FOR WHICH THE CAPACITOR IS DESIGNED, BY WHICH IT IS DESCRIBED AND TO WHICH OTHER RATED VALUES RELATE.

## SURGE VOLTAGE

A SURGE VOLTAGE IS AN A-PERIODIC SINGLE VOLTAGE OF A CERTAIN PROFILE AS DESCRIBED IN IEC 60060-1.

## RATED CURRENT

THE RATED CURRENT OF THE FEED-THROUGH CONDUCTOR IS THE MAXIMUM ALLOWABLE CURRENT WHICH FLOWS DURING THE RATED TEMPERATURE IN THE FEED-THROUGH CONDUCTOR OF THE CAPACITOR.

### NOTE:

THE CURRENT OF THE CONDUCTOR IS GENERALLY DETERMINED BY THE RATED CURRENT OF THE SCREENED EQUIPMENT. IN SPECIAL CASES THE HIGH FREQUENCY INTERFERING CURRENT ALSO HAS TO BE TAKEN INTO ACCOUNT.

# GENERAL INFORMATION

## RATED CAPACITANCE

THE RATED CAPACITANCE OF THE CAPACITOR IS THE CAPACITANCE VALUE WHICH CHARACTERIES ITS RATING FOR A TEMPERATURE OF 23 °C AND AFTER WHICH IT IS NAMED.

## INSULATION RESISTANCE

THE INSULATION RESISTANCE IS THE RATIO OF THE APPLIED DC VOLTAGE TO THE CURRENT FLOWING AFTER A STIPULATED TIME INTERVAL.

## TIME CONSTANT

THE SELF-DISCHARGING TIME CONSTANT OF THE CAPACITOR IN SECONDS IS THE PRODUCT OF THE INSULATION RESISTANCE IN  $M\Omega$  AND THE CAPACITANCE IN  $\mu F$ .

## DISSIPATION FACTOR

THE DISSIPATION FACTOR TAN DELTA IS THE RATIO OF THE EFFECTIVE OUTPUT TO THE WATTLES POWER OF THE CAPACITOR AT SINUSOIDAL VOLTAGE OF A DESIGNATED FREQUENCY.

## INSERTION LOSS

THE INSERTION LOSS IS THE RATIO OF THE VOLTAGES BOTH BEFORE AND AFTER THE INSERTION OF THE ATTENUATOR MEASURED AT THE CONNECTIONS.

### NOTE:

IF THE INSERTION LOSS IS MEASURED IN DECIBELS, THE VALUE WILL BE THE VOLTAGE RATIO LOGARITHMISED TO THE BASIS 10 MULTIPLIED BY 20.

## CATEGORY TEMPERATURE RANGE

THE RANGE OF THE AMBIENT TEMPERATURES WHERE THE CAPACITOR MAY BE CONTINUOUSLY OPERATED BASED ON ITS DESIGN IS DEFINED BY THE TEMPERATURE LIMITS OF THE CORRESPONDING CATEGORY.

## UPPER CATEGORY TEMPERATURE

THE UPPER CATEGORY TEMPERATURE IS THE MAXIMUM SURFACE TEMPERATURE FOR CONTINUOUS OPERATION FOR WHICH THE CAPACITOR IS DESIGNED.

### NOTE:

FOR FEED-THROUGH CAPACITORS AND RC-COMBINATIONS THE TEMPERATURE OF THE OUTER SURFACE MAY BE INFLUENCED BY THE OPERATING CURRENT PASSING THROUGH AND CAUSING INTERNAL HEATING. THE CAPACITOR CONNECTIONS ARE REGARDED AS PART OF THE OUTER SURFACE.

## LOWER CATEGORY TEMPERATURE

THE LOWER CATEGORY TEMPERATURE IS THE LOWEST TEMPERATURE OF THE OUTER SURFACE DURING CONTINUOUS OPERATION FOR WHICH THE CAPACITOR IS DESIGNED.



# GENERAL INFORMATION

## CLIMATIC CATEGORY

THE CLIMATIC CATEGORY DEFINES THE LOWER RATED TEMPERATURE/THE UPPER RATED TEMPERATURE/THE HUMIDITY CLASS.

## PASSIVE FLAMMABILITY

THE ABILITY OF THE CAPACITOR TO BURN WITH A FLAME AS A CONSEQUENCE OF THE APPLICATION OF AN EXTERNAL SOURCE OF HEAT. THE CAPACITOR OF FILTER SUPPRESSES RF BY REPRESENTING AN INPENDANCE FOR THE HIGHER FREQUENCIES WHICH GENERALLY DROP WITH FREQUENCY INCREASE. BY INCORPORATING THE CAPACITOR IN-PARALLEL WITH THE INTERFERENCE SOURCE, INTERFERENCES ARE MORE OR LESS SHORT CIRCUITED. A CAPACITOR INCORPORATED IN-PARALLEL WITH POWER SOURCE TERMINAL, SUPPRESSES SYMMETRICAL INTERFERENCES, AND BETWEEN A POWER CONDUCTOR TERMINAL AND THE CASING OR EARTH IT SUPPRESSES ASYMMETRICAL INTERFERENCES. IMPEDANCE THEORETICALLY DROPS LINEARLY WITH FREQUENCY. DUE TO SHIELD INDUCTANCE OF THE CAPACITOR THE CAPACITOR HAS ITS OWN RESONANT FREQUENCY. ABOVE THIS FREQUENCY THE CAPACITOR IS NO SELF-SUPPRESSING COMPONENT FOR INTERFERENCE. THE VALUE OF FREQUENCY IS DECIDEDLY INFLUENCED BY THE INDUCTANCE OF THE CAPACITOR TERMINALS.

THUS WITH TWO-TERMINAL CAPACITORS ITS OWN RESONANT FREQUENCY IS LOWERED AND THE SUPPRESSION RANGE IS REDUCED. FOR FOUR-TERMINAL CAPACITORS THE INDUCTANCE OF CONDUCTORS HAS NO IMPORTANCE SINCE THEY ARE CONNECTED IN SERIES WITH THE CAPACITOR FROM THE T UNIT. FOUR-TERMINAL CAPACITORS CAN BE USED FOR HIGHER FREQUENCIES THAN TWO-TERMINAL ONES. THEREFORE THE MAIN CHARACTERISTIC OF THE TWO-TERMINAL CAPACITOR IS ITS OWN RESONANT FREQUENCY AND FOR THE FOUR-TERMINAL CAPACITOR THE INSERTION LOSS. MINIMUM RESONANT FREQUENCY AND MINIMUM INSERTION LOSS ARE REGULATED BY CERTAIN NATIONAL STANDARDS (VDE 0565-1; 0565-3). THE FILTERS CONSIST OF A COMBINATION OF INDUCTIVE AND CAPACITIVE COMPONENTS. THEY ARE USED ESPECIALLY WHERE GREATER SUPPRESSION IS REQUIRED. THEIR CHARACTERISTIC IS INSERTION LOSS. THEY ARE DEVELOPED FOR INDIVIDUAL REQUEST DEPENDING ON LEVEL OF INTERFERENCE, FREQUENCY RANGE AND REQUIRED SUPPRESSION, ALL OF WHICH CAN BE DIFFERENT TO THAT REGULATED BY STANDARDS.

## IMPORTANT NOTES

### SPECIAL WORKING CONDITIONS FOR METALLIZED CAPACITORS

THE CAPACITORS ARE INTENDED FOR USE AS ELECTROMAGNETIC INTERFERENCE SUPPRESSIONS IN AC 50HZ/60HZ APPLICATIONS. FOR ALL OTHER APPLICATIONS PLEASE CONSULTS OUR COMPANY BEFORE. WE DO NOT GUARANTEE OR TAKE ANY RESPONSIBILITY FOR INAPPROPRIATE PRODUCTION PROCESSING OR USE FOR INAPPROPRIATE APPLICATIONS.

CAPACITORS MUST NOT BE USED IN VERY HUMID AND WARM AMBIENT. IN SUCH CASE THE CAPACITOR MIGHT ABSORB HUMIDITY AND THIS CAN CHANGE THE CHARACTERISTIC OF THE CAPACITORS.

### LIMITED PRODUCT LIABILITY

ISKRA CAN NOT TAKE A RESPONSIBILITY FOR PRODUCTS WITH BRAND MARK ISKRA WHICH WERE DELIVERED TO CUSTOMERS THROUGH THE THIRD PARTY FOR USE IN IMPROPER APPLICATIONS WITHOUT ANY KNOWLEDGE OF ISKRA FOR WHAT PURPOSE OR APPLICATION THE PRODUCTS WILL BE USED.

THEREFORE WE STRONGLY RECOMMEND CONTACTING US FOR ANY EXPLANATION OR SERVICE REGARDING TO OUR PRODUCTS AND THEIR APPLICATIONS FOR OTHER USE.

ISKRA IS EITHER UNFAMILIAR WITH INDIVIDUAL CUSTOMER APPLICATION OR LESS FAMILIAR WITH THEM THAN THE CUSTOMER THEMSELVES. FOR THESE REASONS, IT ALWAYS ULTIMATELY INCUMBENT ON THE CUSTOMER TO CHECK AND DECIDE WHETHER AN ISKRA PRODUCT WITH THE PROPERTIES DESCRIBED IN THE PRODUCT SPECIFICATION IS SUITABLE FOR USE IN A PARTICULAR CUSTOMER APPLICATION.

# GENERAL INFORMATION

## ORDERING FOR INTERFERENCE SUPPRESSION COMPONENTS

WHEN ORDERING, THE FOLLOWING DATA SHOULD BE GIVEN:

- TYPE OF CAPACITOR OR FILTER
- CAPACITANCE
- VOLTAGE
- INDUCTANCE (FOR FILTERS)
- REQUIREMENT FOR DISCHARGING RESISTOR
- TERMINAL DIMENSIONS
- CURRENT (FOR FILTERS AND FOUR TERMINAL CAPACITORS)
- SPECIAL REQUIREMENTS FOR CONNECTING COMPONENTS
- VERSION (M- MINIATURE, CD - CUSTOM DESIGN, HF - HALOGEN-FREE)

### AN EXAMPLE FOR CAPACITOR:

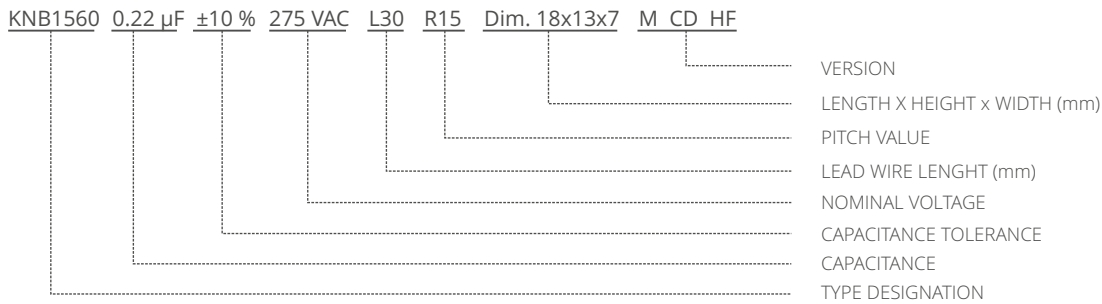

### AN EXAMPLE FOR FILTER:

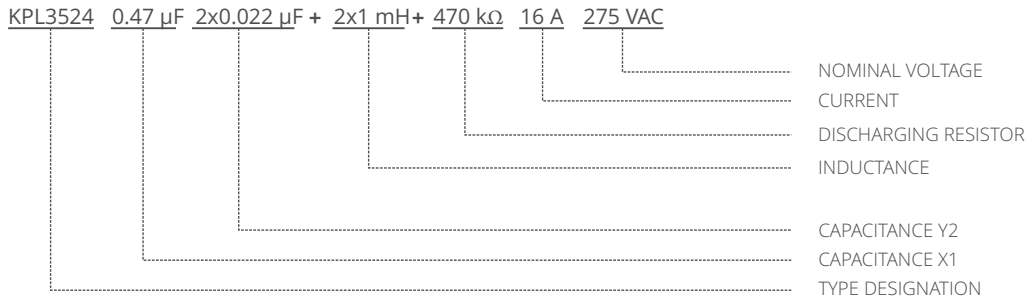

### PRODUCTION DATE CODE MARKING SYSTEM

ACC. TO IEC 60062, CLAUSE 8.2.2. TWO-CHARACTER CODE (YEAR/MONTH)

YEAR	1 <sup>ST</sup> CHARACTER (LETTER)	MONTH	2 <sup>ND</sup> CHARACTER (NUMBER/LETTER)
2010	A	JANUARY	1
2011	B	FEBRUARY	2
2012	C	MARCH	3
2013	D	APRIL	4
2014	E	MAY	5
2015	F	JUNE	6
2016	H	JULY	7
2017	J	AUGUST	8
2018	K	SEPTEMBER	9
2019	L	OCTOBER	O
2020	M	NOVEMBER	N
2021	N	DECEMBER	D
2022	P		
2023	R		
2024	S		
2025	T		
2026	U		
2027	V		
2028	W		
2029	X		
2030	A		

THE PRODUCTION DATE CODE IS INDICATED WITH TWO-CHARACTERS. THE 1<sup>ST</sup> CHARACTER (LETTER) INDICATES THE YEAR AND 2<sup>ND</sup> CHARACTER (NUMBER/LETTER) INDICATES THE MONTH.

# GENERAL INFORMATION

## TAPING SPECIFICATION FOR RADIAL CAPACITORS

ACC. TO IEC 60286-2

(ROBOTIC INSERTION)

DESCRIPTIONS	SYMBOL	DIMENSIONS (mm)			TOLERANCES
		LEAD SPACING 10 mm	LEAD SPACING 15 mm	LEAD SPACING 22.5 mm	
CARRIER TAPE WIDTH	W	18	18	18	+1 / -0.5
HOLD-DOWN TAPE WIDTH	$W_0$	12 OR 6	12 OR 6	12 OR 6	± 0.5
HOLE POSITION	$W_1$	9	9	9	± 0.5
HOLD-DOWN TAPE POSITION	$W_2$	3	3	3	MAX.
FEED HOLE DIAMETER	$D_0$	4	4	4	± 0.2
PITCH OF COMPONENT	P	25.4	25.4	38.1	± 1
FEED HOLE PITCH	$P_0^*$	12.7	12.7	12.7	± 0.2
FEED HOLE CENTRE TO LEAD	$P_1$	7.7	5.2	7.8	± 0.7
FEED HOLE CENTRE TO COMPONENT CENTRE	$P_2$	12.7	12.7	19.05	± 1.3
HEIGHT FROM FEED HOLE CENTRE TO THE COMPONENT BODY	H	18.5	18.5	18.5	± 0.5
COMPONENT ALIGNMENT	$Dp$	0	0	0	± 1.3
	DS	0	0	0	± 2
LEAD SPACING	p	10	15	22.5	+ 0.6 / -0.1
LEAD WIRE DIAMETER	d	0.6	0.8	0.8	± 0.05
TOTAL TAPE THICKNESS	t	0.7	0.7	0.7	± 0.2
EXTRACTION FORCE FOR COMPONENTS	$F_1$	5	5	5	MIN. (N)
BREAK FORCE OF THE TAPE	$F_2$	15	15	15	MIN. (N)
COMPONENTS HEIGHT	$H_1$	31	34	39	MAX.

\* CUMULATIVE PITCH ERROR OVER ANY 20 PITCHES: MAX. ± 1 mm

FIGURE 6

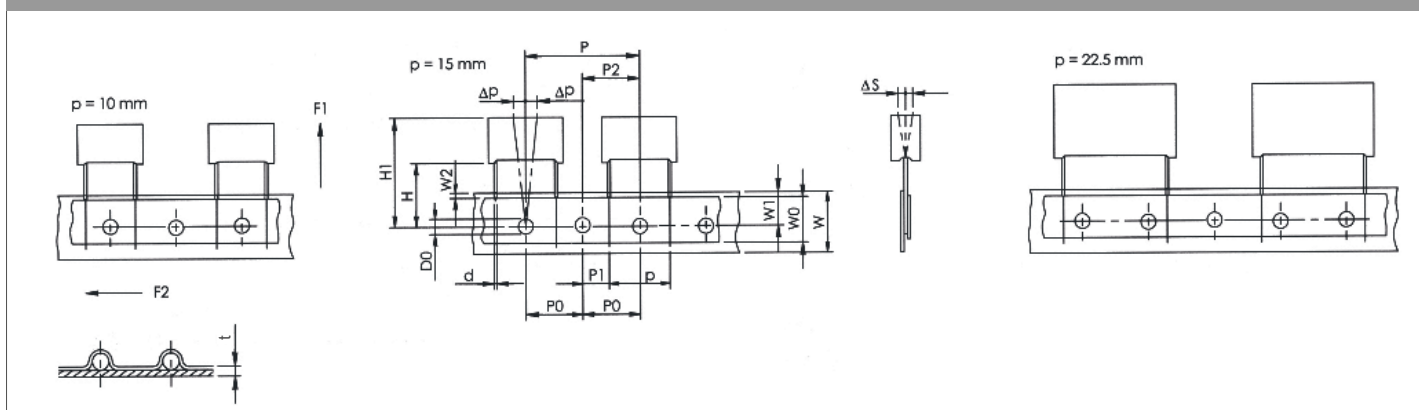

PITCH (mm)	CAPACITOR THICKNESS b (mm)	AMMO-PACK (pcs/box)	REEL-PACK (pcs/reel)
10	4; 4.3	900	900
	5	768	700
	6	648	550
15	5	768	600
	5.5	696	600
	6	648	500
	7	552	450
	7.5	504	400
	8.5	444	400
22.5	9	420	400
	6	424	370
	6.5	392	350
	7	368	300
	8.5	304	250
	10	256	200
	10.5	240	200

FIGURE 7

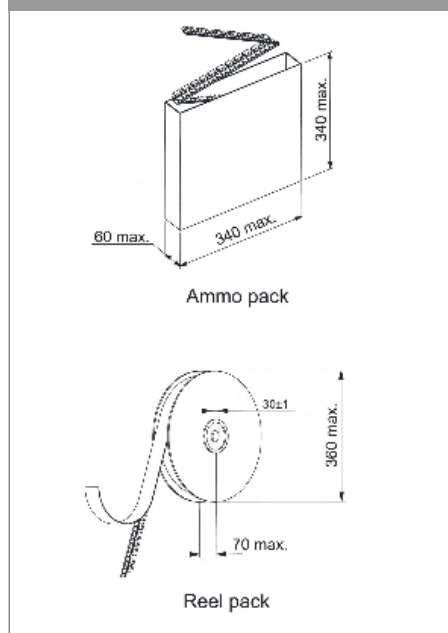

# CAPACITORS

## TYPE KNB1530, KNB1532, KNB1533

**CLASS X2**  
275 V AC  
300 V AC

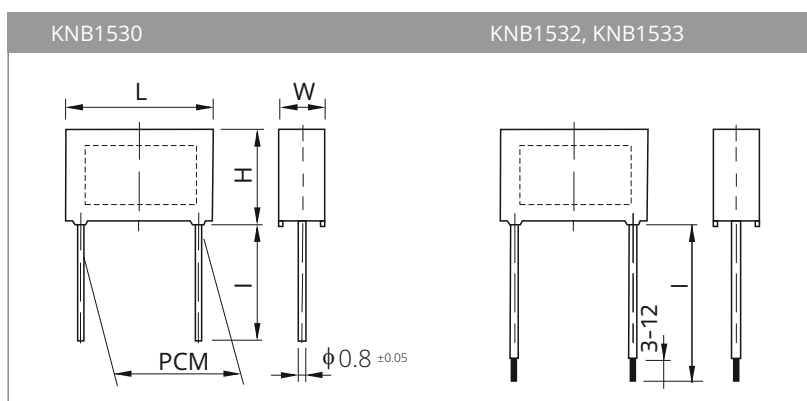
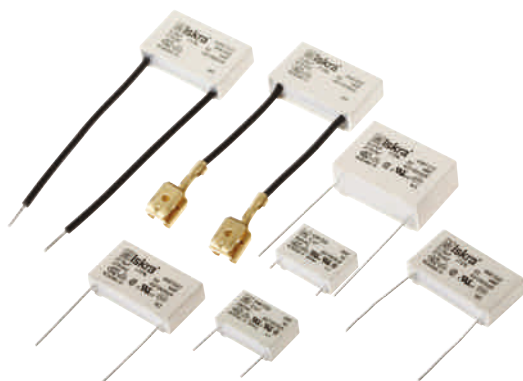

### ELECTRICAL CONNECTION

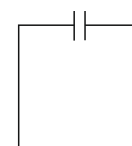

### TECHNICAL DATA

■ CONSTRUCTION	POLYPROPYLENE FILM, METALLIZED
■ RATED VOLTAGE	275 V AC, 300 V AC
■ CAPACITANCE TOLERANCE	± 20 % FOR C ≤ 0.1 μF ± 10 % FOR C > 0.1 μF
■ CLIMATIC CATEGORY	40/100/56 ACC. TO IEC 60068-1
■ PASSIVE FLAMMABILITY	ACC. TO IEC 60384-14
■ TEMPERATURE RANGE	-40 ° TO +100 °C
■ TEST VOLTAGE	2200 V DC, 1s FOR C ≤ 1 μF 1900 V DC, 2s FOR 1 μF < C ≤ 2.2 μF 1600 V DC, 2s FOR C > 2.2 μF
■ MAX. PULSE RISE TIME du/dt, AT 390 V DC FOR 275 V AC AND 425 V DC FOR 300 V AC	900 V / μs FOR PCM = 10 mm 400 V / μs FOR PCM = 15 mm 200 V / μs FOR PCM = 22.5 mm 160 V / μs FOR PCM = 27.5 mm 100 V / μs FOR PCM = 37.5 mm
■ INSULATION RESISTANCE AT 20 °C, U <sub>m</sub> = 100 V DC, t = 1 min	R <sub>i</sub> ≥ 15000 MΩ FOR C ≤ 0.33 μF R <sub>i</sub> × C <sub>n</sub> ≥ 5000 s FOR C > 0.33 μF
■ DIELECTRIC LOSS TAN δ AT F = 1 kHz AND 20 °C	1 × 10 <sup>-3</sup>
■ SOLDERING	IEC 60068-2-20, MAX. 2 s
■ RESISTANCE TO SOLDERING HEAT	IEC 60068-2-20, 260 °C ± 5 °C, 10 s ± 1 s
■ MAX. ALTITUDE	M6: 5 Nm; M8: 6 Nm
■ SELF INDUCTANCE	APPROX. 10 nH/cm OF CAPACITOR LENGTH AND TERMINALS
■ COMPLIES TO	IEC 60384-14, UL 60384-14 CSA 60384-14
■ APPLICATION	RFI SUPPRESSION CLASS X2 (ACROSS-THE-LINE CONNECTION) CAPACITOR IS AVAILABLE IN CD VERSION SUITABLE FOR SERIES CONNECTION TO THE SUPPLY MAINS (CAPACITIVE POWER SUPPLY)

# CAPACITORS

## TYPE KNB1530, KNB1532, KNB1533

ø 0.6 mm FOR PCM = 10 mm  
ø 0.8 mm FOR PCM > 10 mm



CASING: THERMOPLASTIC  
(PP OR ON REQUEST PBT HF)  
SEALED WITH SYNTHETICAL RESIN

THERMOPLASTIC MATERIAL IS SELF-EXTINGUISHING ACCORDING TO UL 94, CLASS V-0

### TERMINALS

TYPE	TERMINAL LENGTH	TYPE OF TERMINALS
KNB1530	3 <sup>+0.5</sup> , 4 <sup>+0.5</sup> , 6 <sup>-1</sup> , 9 <sup>+1</sup> , 15 <sup>+2</sup> , 20 <sup>+2</sup> , 25 <sup>+5</sup> , 30 <sup>+5</sup> , 50 <sup>+5</sup> mm, OTHER ON REQUEST	TINNED COPPER WIRE
KNB1532	20 TO 200 mm	INSULATED STRANDED WIRE 0.5 mm <sup>2</sup>
KNB1533	20 TO 200 mm	INSULATED SOLID WIRE ø0.8 mm, TERMINAL ENDS ON REQUEST

### STANDARD VALUES KNB1530, KNB1532, KNB1533, 275 V AC, CLASS X2

CAPACITANCE C (µF)	DIMENSIONS					FOR CAPACITORS WITH INSULATED LEADS ON REQUEST	
	L (mm)	H (mm)	W (mm)	PCM (mm)		 275 V AC	 IEC 60384-14 275 V AC
0.01*	13	9.5	4.3	10	●	●	●
0.015*	13	10.5	5	10	●	●	●
0.022*	13	11.5	6	10	●	●	●
0.01	18	11	5.5	15	●	●	●
0.015	18	11	5.5	15	●	●	●
0.022	18	11	5.5	15	●	●	●
0.033	18	11	5.5	15	●	●	●
0.047	18	11	5.5	15	●	●	●
0.068	18	12	6	15	●	●	●
0.1*	18	12	6	15	●	●	●
0.1	18	13	7	15	●	●	●
0.1	18	14.5	9	15	●	●	●
0.12	18	13.5	7.5	15	●	●	●
0.15*	18	14.5	9	15	●	●	●
0.15*	18	14.5	8.5	15	●	●	●
0.22*	18	18.5	9	15	●	●	●
0.22*	18	19	10	15	●	●	●
0.33*	18	20	12.5	15	●	●	●
0.15	26.5	15.5	7.5	22.5	●	●	●
0.15	27	15	6.5	22.5	●	●	●
0.22	27	16.5	7	22.5	●	●	●
0.22	26.5	16.5	8.5	22.5	●	●	●
0.27	27	18.5	8.5	22.5	●	●	●
0.33	27	18.5	8.5	22.5	●	●	●
0.47	27	19	10.5	22.5	●	●	●
0.47	27	20	10.5	22.5	●	●	●
0.47*	26	22	9.5	22.5	●	●	●
0.47	32	20	11	27.5	●	●	●
0.56	31.5	19	10	27.5	●	●	●
0.68	32	20	11	27.5	●	●	●
1*	31.5	22	13	27.5	●	●	●
1	31.5	23.5	14	27.5	●	●	●
1	32	24.5	15	27.5	●	●	●
1.5	31.5	26.5	17	27.5	●	●	●
1.5	32	28	18	27.5	●	●	●
2.2	31.5	32	18	27.5	●	●	●
2.2	32	33	20	27.5	●	●	●
1.5	41.5	23	14	37.5	●	●	●
2.2	41.5	26	18	37.5	●	●	●
2.2	41.5	27	16	37.5	●	●	●
2.2	41.5	31	18	37.5	●	●	●



\* MINI SIZE MARKING WITH 

● APPROVALS IN USE

# CAPACITORS

## TYPE KNB1530, KNB1532, KNB1533

### STANDARD VALUES KNB1530, KNB1532, KNB1533, 300 V AC, CLASS X2

CAPACITANCE C (μF)	L (mm)	H (mm)	W (mm)	PCM (mm)		FOR CAPACITORS WITH INSULATED LEADS ON REQUEST	
							
0.01	13	9	4	10	●	●	●
0.015	13	9	4	10	●	●	●
0.022	13	10.5	5	10	●	●	●
0.033	13	11.5	6	10	●	●	●
0.047	13	13.5	6	10	●	●	●
0.01	18	11	5	15	●	●	●
0.015	18	11	5	15	●	●	●
0.022	18	11	5	15	●	●	●
0.033	18	11	5	15	●	●	●
0.047	18	11	5	15	●	●	●
0.068	18	11	5.5	15	●	●	●
0.1	18	12	6	15	●	●	●
0.12	18	13	7	15	●	●	●
0.15	18	13.5	7.5	15	●	●	●
0.22	18	16.5	8.5	15	●	●	●
0.27	18	18.5	11	15	●	●	●
0.33	18	18.5	11	15	●	●	●
0.1	26.5	14	6	22.5	●	●	●
0.15	26.5	14	6	22.5	●	●	●
0.22	27	15	6.5	22.5	●	●	●
0.33	26.5	16.5	8.5	22.5	●	●	●
0.47	26.5	18.5	10	22.5	●	●	●
0.56	27	20	10.5	22.5	●	●	●
0.33	31.5	16	7.5	27.5	●	●	●
0.47	32	17	9	27.5	●	●	●
0.56	31.5	17.5	10	27.5	●	●	●
0.68	32	18.5	11	27.5	●	●	●
1	31.5	22	13	27.5	●	●	●
1.5	31.5	26.5	17	27.5	●	●	●
2.2	31.5	32	18	27.5	●	●	●
2.7	31.5	32	18	27.5	●	●	●
3.3	31.5	32	18	27.5	●	●	●
3.3	31.5	33	20	27.5	●	●	●
3.9	31.5	33	20	27.5	●	●	●
4.7	32	39	24	27.5	●	●	●
5.6	32	39	24	27.5	●	●	●
1.5	41.5	22	14	37.5	●	●	●
2.2	41.5	27	16	37.5	●	●	●
2.2	41.5	26	18	37.5	●	●	●
3.3	41.5	26	18	37.5	●	●	●
3.9	41.5	31	18	37.5	●	●	●
4.7	41.5	32	19	37.5	●	●	●
5.6	41.5	38	21	37.5	●	●	●
6.8	41.5	38	21	37.5	●	●	●
8.2	41.5	43	28	37.5	●	●	●
10	41.5	43	28	37.5	●	●	●
10	42	45	30	37.5	●	●	●

\* MINI SIZE MARKING WITH 

● APPROVALS IN USE

**NOTE:**  
APPROVAL CQC ONLY FOR PBT HF CASE

# CAPACITORS WITH DISCHARGE RESISTOR

## TYPE KNB1530, KNB1532, KNB1533

**CLASS X2**  
275 V AC  
300 V AC

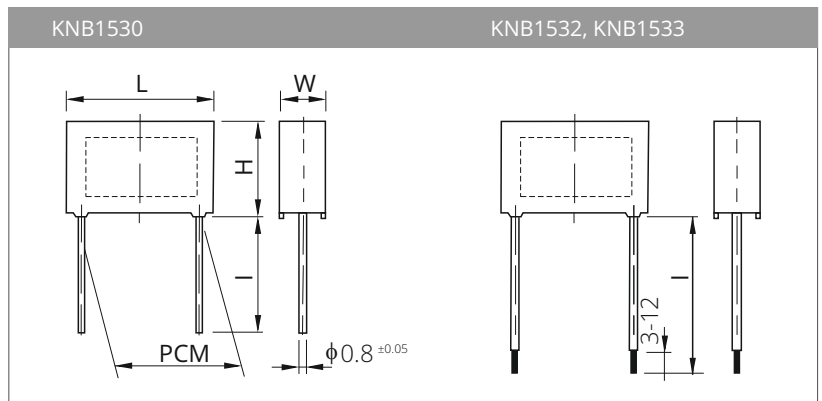
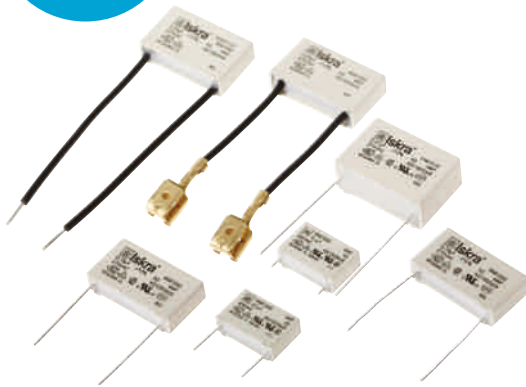

### ELECTRICAL CONNECTION

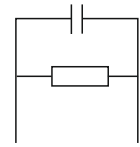

### TECHNICAL DATA

■ CONSTRUCTION: - CAPACITOR - RESISTOR	POLYPROPYLENE FILM, METALLIZED METALOXIDE FILM
■ RATED VOLTAGE	275 V AC, 300 V AC
■ CAPACITANCE TOLERANCE	$\pm 20\%$ FOR $C \leq 0.1 \mu\text{F}$ $\pm 10\%$ FOR $C > 0.1 \mu\text{F}$
■ RESISTANCE TOLERANCE	$\pm 5\%$
■ RESISTANCE POWER	0.6 W
■ CLIMATIC CATEGORY	40/100/56 ACC. TO IEC 60068-1
■ PASSIVE FLAMMABILITY	ACC. TO IEC 60384-14
■ TEMPERATURE RANGE	$-40^\circ\text{C}$ to $+100^\circ\text{C}$
■ TEST VOLTAGE	2200 V DC, 1 s
■ MAX. PULSE RISE TIME $du/dt$ , AT 425 V DC	400 V / $\mu\text{s}$ FOR PCM = 15 mm 200 V / $\mu\text{s}$ FOR PCM = 22.5 mm 160 V / $\mu\text{s}$ FOR PCM = 27.5 mm 100 V / $\mu\text{s}$ FOR PCM = 37.5 mm
■ INSULATION RESISTANCE AT $20^\circ\text{C}$ , $U_m = 100\text{ V DC}$ , $t = 1\text{ min}$	$R_i \geq 15000\text{ M}\Omega$ FOR $C \leq 0.33 \mu\text{F}$ $R_i \times C_n \geq 5000\text{ s}$ FOR $C > 0.33 \mu\text{F}$
■ DIELECTRIC LOSS $\text{TAN}\delta$ AT $F = 1\text{ kHz}$ AND $20^\circ\text{C}$	$1 \times 10^{-3}$
■ SOLDERING	IEC 60068-2-20, max. 2 s
■ RESISTANCE TO SOLDERING HEAT	IEC 60068-2-20, $260^\circ\text{C} \pm 5^\circ\text{C}$ , $10\text{ s} \pm 1\text{ s}$
■ SELF INDUCTANCE	APPROX. 10 nH/cm OF CAPACITOR LENGTH AND TERMINALS
■ COMPLIES TO	IEC 60384-14, CSA 60384-14
■ APPLICATION	RFI SUPPRESSION CLASS X2 (ACROSS-THE-LINE CONNECTION) CAPACITOR IS AVAILABLE IN CD VERSION SUITABLE FOR SERIES CONNECTION TO THE SUPPLY MAINS (CAPACITIVE POWER SUPPLY)

# CAPACITORS WITH DISCHARGE RESISTOR

## TYPE KNB1530, KNB1532, KNB1533



CASING: THERMOPLASTIC  
(PP OR ON REQUEST PBT HF)  
SEALED WITH SYNTHETICAL RESIN

THERMOPLASTIC MATERIAL AND SYNTHETICAL RESIN ARE SELF-EXTINGUISHING ACCORDING TO UL 94. CLASS V-0.

### TERMINALS

TYPE	TERMINAL LENGTH	TYPE OF TERMINALS
KNB1530	3 <sup>±0.5</sup> , 4 <sup>±0.5</sup> , 6 <sup>±1</sup> , 9 <sup>±1</sup> , 15 <sup>±2</sup> , 20 <sup>±2</sup> , 25 <sup>±3</sup> , 30 <sup>±5</sup> , 50 <sup>±5</sup> mm, OTHER ON REQUEST	TINNED COPPER WIRE
KNB1532	20 TO 200 mm	INSULATED STRANDED WIRE 0.5 mm <sup>2</sup>
KNB1533	20 TO 200 mm	INSULATED SOLID WIRE $\phi$ 0.8 mm, TERMINAL ENDS ON REQUEST

### STANDARD VALUES KNB1530, KNB1532, KNB1533, 275 V AC, CLASS X2, WITH DISCHARGE RESISTOR

CAPACITANCE C (μF)	RESISTANCE R (kΩ)	DIMENSIONS				 IEC 60384-14 275 V AC	 CSA 60384-14 275 V AC
		L (mm)	H (mm)	W (mm)	PCM (mm)		
0.047	470 TO 2700	18	13	7	15	●	●
0.068		18	13	7	15	●	●
0.1		18	14.5	9	15	●	●
0.15		27	16.5	7	22.5	●	●
0.22		26.5	16.5	8.5	22.5	●	●
0.22		27	18.5	8.5	22.5	●	●
0.33		26.5	18.5	10	22.5	●	●
0.47		26.5	20.5	11	22.5	●	●
0.47		32	20	11	27.5	●	●

RESISTANCE VALUES ACCORDING TO IEC 60063 RANGE E12.

● APPROVALS IN USE

### STANDARD VALUES KNB1530, KNB1532, KNB1533, 300 V AC, CLASS X2, WITH DISCHARGE RESISTOR

CAPACITANCE C (μF)	RESISTANCE R (kΩ)	DIMENSIONS				 IEC 60384-14 300 V AC	 CSA 60384-14 300 V AC
		L (mm)	H (mm)	W (mm)	PCM (mm)		
0.047	470 TO 2700	18	12	6	15	●	●
0.068		18	13	7	15	●	●
0.1		18	13.5	7.5	15	●	●
0.15		18	16.5	8.5	15	●	●
0.22		18	18.5	9	15	●	●
0.33		18	20	12.5	15	●	●
0.15		27	15	6.5	22.5	●	●
0.22		27	16.5	7	22.5	●	●
0.33		27	18.5	8.5	22.5	●	●
0.47	27	20	10.5	22.5	●	●	
0.47	31.5	19	10	27.5	●	●	

RESISTANCE VALUES ACCORDING TO IEC 60063 RANGE E12.

● APPROVALS IN USE



# CAPACITORS

## TYPE KNB1560, KNB1562, KNB1563

CLASS X2  
275 V AC

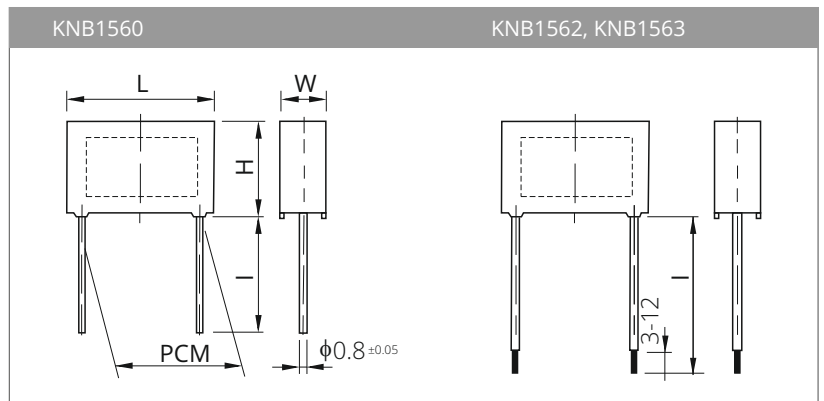
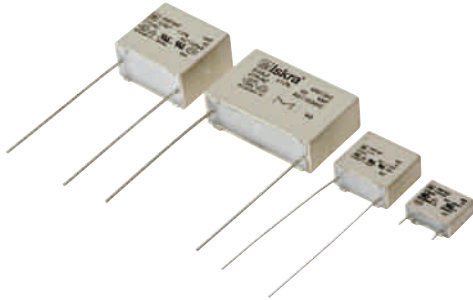

### ELECTRICAL CONNECTION

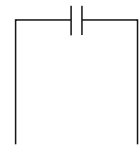

### TECHNICAL DATA

■ CONSTRUCTION	POLYPROPYLENE FILM, METALLIZED
■ RATED VOLTAGE	275 V AC
■ CAPACITANCE TOLERANCE	$\pm 20\%$ FOR $C \leq 0.1 \mu\text{F}$ $\pm 10\%$ FOR $C > 0.1 \mu\text{F}$
■ CLIMATIC CATEGORY	40/100/56 ACC. TO IEC 60068-1
■ PASSIVE FLAMMABILITY	ACC. TO IEC 60384-14
■ TEMPERATURE RANGE	$-40^\circ\text{C}$ to $+110^\circ\text{C}$
■ TEST VOLTAGE	2200 V DC, 1 s FOR $C \leq 1 \mu\text{F}$ 1900 V DC, 1 s FOR $C > 1 \mu\text{F}$
■ MAX. PULSE RISE TIME $du/dt$ , AT 390 V DC	500 V / $\mu\text{s}$ FOR PCM $C > 1 \mu\text{F}$ 400 V / $\mu\text{s}$ FOR PCM = 15 mm $C > 0.022 \mu\text{F}$ 250 V / $\mu\text{s}$ FOR PCM = 15 mm $C > 0.022 \mu\text{F}$ 150 V / $\mu\text{s}$ FOR PCM = 22.5 mm 100 V / $\mu\text{s}$ FOR PCM = 27.5 mm 500 V / $\mu\text{s}$ FOR PCM = 7.5 mm MINIATURE VERSION 350 V / $\mu\text{s}$ FOR PCM = 10 mm MINIATURE VERSION
■ INSULATION RESISTANCE AT $20^\circ\text{C}$ , $U_m = 100 \text{ V DC}$ , $t = 1 \text{ min}$	$R_i \geq 15000 \text{ M}\Omega$ FOR $C \leq 0.33 \mu\text{F}$ $R_i \times C_n \geq 5000 \text{ s}$ FOR $C > 0.33 \mu\text{F}$
■ DIELECTRIC LOSS $\text{TAN}\delta$ AT $F = 1 \text{ KHZ}$ AND $20^\circ\text{C}$	$\leq 1 \times 10^{-3}$
■ SOLDERING	IEC 60068-2-20, MAX. 2 s
■ RESISTANCE TO SOLDERING HEAT	IEC 60068-2-20, $260^\circ\text{C} \pm 5^\circ\text{C}$ , $10 \text{ s} \pm 1 \text{ s}$
■ SELF INDUCTANCE	APPROX. 10 nH/cm OF CAPACITOR LENGTH AND TERMINALS
■ COMPLIES TO	IEC 60384-14, UL 60384-14 CSA 60384-14
■ APPLICATION	RFI SUPPRESSION CLASS X2 (ACROSS-THE-LINE CONNECTION) CAPACITOR IS AVAILABLE IN CD VERSION SUITABLE FOR SERIES CONNECTION TO THE SUPPLY MAINS (CAPACITIVE POWER SUPPLY)

# CAPACITORS

## TYPE KNB1560, KNB1562, KNB1563

CASING: THERMOPLASTIC (PP OR ON REQUEST PBT HF) SEALED WITH SYNTHETICAL RESIN	THERMOPLASTIC MATERIAL AND SYNTHETICAL RESIN ARE SELF-EXTINGUISHING ACCORDING TO UL 94. CLASS V-0.	
TERMINALS		
TYPE	TERMINAL LENGHT	TYPE OF TERMINALS
KNB1560	3 <sup>+0.5</sup> , 4 <sup>+0.5</sup> , 6 <sup>-1</sup> , 9 <sup>+1</sup> , 15 <sup>+2</sup> , 20 <sup>+2</sup> , 25 <sup>+5</sup> , 30 <sup>+5</sup> , 50 <sup>+5</sup> mm, OTHER ON REQUEST	TINNED COPPER WIRE
KNB1562	20 TO 200 mm	INSULATED STRANDED WIRE 0.5 mm <sup>2</sup>
KNB1563	20 TO 200 mm	INSULATED SOLID WIRE $\phi$ 0.8 mm , TERMINAL ENDS ON REQUEST

### STANDARD VALUES KNB1560, KNB1562, KNB1563, 275 V AC, CLASS X2



CAPACITANCE C (μF)	DIMENSIONS					 IEC 60384-14 275 V AC	FOR CAPACITORS WITH INSULATED LEADS ON REQUEST	
	L (mm)	H (mm)	W (mm)	PCM (mm)	ø (mm)		 UL 60384-14 CSA 60384-14 275 V AC	 IEC 60384-14 275 V AC
0.01	13	9	4	10	0.6	●	●	●
0.015	13	9	4	10	0.6	●	●	●
0.022	13	9	4	10	0.6	●	●	●
0.033	13	9	4	10	0.6	●	●	●
0.033	13	10.5	5	10	0.6	●	●	●
0.047	13	10.5	5	10	0.6	●	●	●
0.047	13	11.5	6	10	0.6	●	●	●
0.068	13	11	5.5	10	0.6	●	●	●
0.1	13	12	6	10	0.6	●	●	●
0.01	18	11	5	15	0.8	●	●	●
0.015	18	11	5	15	0.8	●	●	●
0.022	18	11	5	15	0.8	●	●	●
0.033	18	11	5	15	0.8	●	●	●
0.047	18	11	5	15	0.8	●	●	●
0.068	18	11	5	15	0.8	●	●	●
0.1	18	11	5.5	15	0.8	●	●	●
0.12	18	12	6	15	0.8	●	●	●
0.15	18	13	7	15	0.8	●	●	●
0.22	18	14.5	8.2	15	0.8	●	●	●
0.27	18	14.5	9	15	0.8	●	●	●
0.33	18	16	9.5	15	0.8	●	●	●
0.33	18	19.5	7.5	15	0.8	●	●	●
0.47	18	18.5	11	15	0.8	●	●	●
0.56	18	20	12.5	15	0.8	●	●	●
0.15	26.5	14	6	22.5	0.8	●	●	●
0.22	26.5	14	6	22.5	0.8	●	●	●
0.27	26.5	15	6	22.5	0.8	●	●	●
0.33	26.5	16	7	22.5	0.8	●	●	●
0.47	26.5	17	8.5	22.5	0.8	●	●	●
0.56	26.5	18.5	9	22.5	0.8	●	●	●
0.68	26.5	18.5	10	22.5	0.8	●	●	●
1	26.5	21.5	12.5	22.5	0.8	●	●	●
0.47	31.5	16	7.5	27.5	0.8	●	●	●
0.56	32	17	9	27.5	0.8	●	●	●
0.68	32	17	9	27.5	0.8	●	●	●
1	32	20	11	27.5	0.8	●	●	●
1.5	31.5	23.5	14	27.5	0.8	●	●	●
2.2	31.5	26.5	17	27.5	0.8	●	●	●

● APPROVALS IN USE

# CAPACITORS

## TYPE KNB1560, KNB1562, KNB1563

### STANDARD VALUES KNB1560, KNB1562, KNB1563, 275 V AC, CLASS X2, MINIATURE VERSION

CAPACITANCE		DIMENSIONS					 IEC 60384-14 275 V AC	FOR CAPACITORS WITH INSULATED LEADS ON REQUEST	
C (µF)	TOLERANCE ± (%)	L (mm)	H (mm)	W (mm)	PCM (mm)	 UL 60384-14 CSA 60384-14 275 V AC		 IEC 60384-14 275 V AC	
0.01	20	10.5	9	4	7.5	0.6	●	●	●
0.015	20	10.5	9	4	7.5	0.6	●	●	●
0.022	20	10.5	9	4	7.5	0.6	●	●	●
0.033	20	10.5	10	5	7.5	0.6	●	●	●
0.047	20	10.5	11	5.5	7.5	0.6	●	●	●
0.068	10, 20	13	11	5.5	10	0.6	●	●	●
0.1	20	13	11	5	10	0.6	●	●	●
0.1	10, 20	13	11	5.5	10	0.6	●	●	●
0.1	10, 20	18	11	5	15	0.8	●	●	●
0.12	20	18	11	5	15	0.8	●	●	●
0.12	10, 20	18	11	5.5	15	0.8	●	●	●
0.15	20	18	11	5.5	15	0.8	●	●	●
0.15	10, 20	18	12	6	15	0.8	●	●	●
0.18	10, 20	18	12	6	15	0.8	●	●	●
0.22	20	18	12.5	6.5	15	0.8	●	●	●
0.22	10, 20	18	13	7	15	0.8	●	●	●
0.27	20	18	13	7	15	0.8	●	●	●
0.27	10, 20	18	13.5	7.5	15	0.8	●	●	●
0.33	10, 20	18	16	7.5	15	0.8	●	●	●
0.33	10, 20	18	14.5	8.2	15	0.8	●	●	●
0.39	20	18	19.5	7.5	15	0.8	●	●	●
0.39	10, 20	18	16.5	8.5	15	0.8	●	●	●
0.47	20	18	16	9.5	15	0.8	●	●	●
0.47	10, 20	18	18.5	9	15	0.8	●	●	●
0.56	20	18	18.5	9	15	0.8	●	●	●
0.56	10, 20	18	19	10	15	0.8	●	●	●
0.56	10, 20	18	18.5	11	15	0.8	●	●	●
0.68	20	18	18.5	11	15	0.8	●	●	●
0.68	10, 20	18	22	10	15	0.8	●	●	●
0.68	10, 20	18	20	11	15	0.8	●	●	●
0.68	10, 20	18	20	12.5	15	0.8	●	●	●
0.82	10, 20	18	20	12.5	15	0.8	●	●	●
1	10, 20	18	25	12.5	15	0.8	●	●	●
1	10, 20	18	17	19.5	15	0.8	●	●	●
0.47	10, 20	26.5	16	7	22.5	0.8	●	●	●
0.56	10, 20	26.5	16.5	7.5	22.5	0.8	●	●	●
0.68	10, 20	26.5	17	8.5	22.5	0.8	●	●	●
0.82	10, 20	26.5	18.5	9	22.5	0.8	●	●	●
1	10, 20	26.5	19.5	10	22.5	0.8	●	●	●
1	10, 20	27	20	10.5	22.5	0.8	●	●	●
1.2	10, 20	26.5	20.5	11	22.5	0.8	●	●	●
1.5	10, 20	26.5	21.5	12.5	22.5	0.8	●	●	●
1.8	10, 20	27	23	14	22.5	0.8	●	●	●
2.2	10, 20	26.5	26.5	14.5	22.5	0.8	●	●	●
2.2	10, 20	27	25	16	22.5	0.8	●	●	●
1	10, 20	31.5	19	10	27.5	0.8	●	●	●
1.5	10, 20	31.5	21	12	27.5	0.8	●	●	●
2.2	10, 20	31.5	23.5	14	27.5	0.8	●	●	●
2.7	10, 20	32	28.5	15	27.5	0.8	●	●	●
3.3	10, 20	31.5	26.5	17	27.5	0.8	●	●	●
3.9	10, 20	31.5	32	18	27.5	0.8	●	●	●
4.7	10, 20	31.5	33	20	27.5	0.8	●	●	●
5.6	10, 20	31.5	35.5	24	27.5	0.8	●	●	●
6.8	10, 20	32	39	24	27.5	0.8	●	●	●

\* MINI SIZE MARKING WITH  EXCEPT PCM 7.5 mm

- APPROVALS IN USE
- APPROVALS IN PENDING

**NOTE:**  
 BOLD-FACE PRINTED ALTERNATIVE BODY DIMENSIONS UPON REQUEST.  
 CQC DOES NOT APPLY FOR PP CASE PCM = 15 mm (C=0.82 µF AND 1 µF) AND PCM ≥ 22.5 mm

# CAPACITORS

## TYPE KNB1560, KNB1562, KNB1563

**CLASS X2**  
275 V AC  
+125 °C

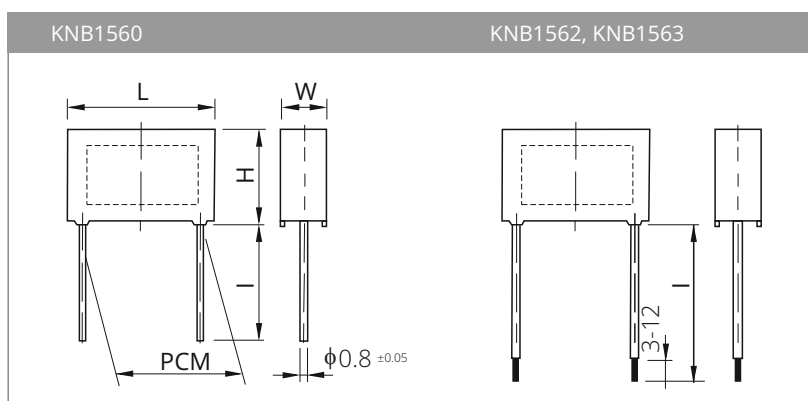
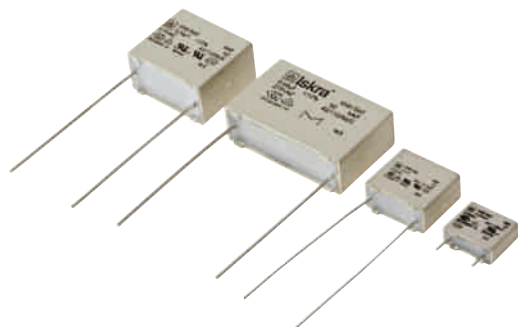

### ELECTRICAL CONNECTION

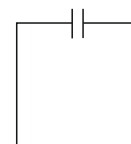

### TECHNICAL DATA



■ CONSTRUCTION	POLYPROPYLENE FILM, METALLIZED
■ RATED VOLTAGE	275 V AC
■ CAPACITANCE TOLERANCE	$\pm 20 \%$ , $\pm 10 \%$
■ CLIMATIC CATEGORY	40/100/56 ACC. TO IEC 60068-1
■ PASSIVE FLAMMABILITY	ACC. TO IEC 60384-14
■ TEMPERATURE RANGE	-40 ° TO +125 °C
■ TEST VOLTAGE	2200 V DC, for 1 s
■ MAX. PULSE RISE TIME du/dt, AT 390 V DC	550 V / ms FOR PCM = 7.5 mm 350 V / ms FOR PCM = 10 mm 200 V / ms FOR PCM = 15 mm
■ INSULATION RESISTANCE AT 20 °C , $U_m = 100$ V DC, t = 1 min	$R_i \geq 15000$ M $\Omega$ FOR $C_x \leq 0.33$ $\mu$ F $R_i \times C_x \geq 5000$ s FOR $C_x > 0.33$ $\mu$ F
■ DIELECTRIC LOSS TAN $\delta$ AT F = 1 kHz AND 20 °C	$\leq 1 \times 10^{-3}$
■ SOLDERING	IEC 60068-2-20, MAX. 2 s
■ RESISTANCE TO SOLDERING HEAT	IEC 60068-2-20, 260 °C $\pm 5$ °C, 10 s $\pm 1$ s
■ SELF INDUCTANCE	APPROX. 10 nH/cm OF CAPACITOR LENGHT AND TERMINALS
■ COMPLIES TO	IEC 60384-14, UL 60384-14 CSA 60384-14
■ APPLICATION	RFI SUPPRESSION CLASS X2 (ACROSS-THE-LINE CONNECTION) CAPACITOR IS AVAILABLE IN CD VERSION SUITABLE FOR SERIES CONNECTION TO THE SUPPLY MAINS (CAPACITIVE POWER SUPPLY)

# CAPACITORS

## TYPE KNB1560, KNB1562, KNB1563

CASING: THERMOPLASTIC (PP OR ON REQUEST PBT HF) SEALED WITH SYNTHETICAL RESIN	THERMOPLASTIC MATERIAL AND SYNTHETICAL RESIN ARE SELF-EXTINGUISHING ACCORDING TO UL 94. CLASS V-0.	
TERMINALS		
TYPE	TERMINAL LENGTH	TYPE OF TERMINALS
KNB1560	4 <sup>±0.5</sup> , 6 <sup>-1</sup> , 25 <sup>+5</sup> mm, OTHER ON REQUEST	TINNED COPPER WIRE
KNB1562	20 TO 200 mm	INSULATED STRANDED WIRE 0.5 mm <sup>2</sup>
KNB1563	20 TO 200 mm	INSULATED SOLID WIRE $\phi$ 0.8 mm, TERMINAL ENDS ON REQUEST

### STANDARD VALUES KNB1560, KNB1562, KNB1563, 275 V AC, CLASS X2, + 125 °C, MINIATURE VERSION

CAPACITANCE		DIMENSIONS					 IEC 60384-14 275 V AC	FOR CAPACITORS WITH INSULATED LEADS ON REQUEST	
C (µF)	TOLERANCE ± (%)	L (mm)	H (mm)	W (mm)	PCM (mm)	∅ (mm)		 UL 60384-14 CSA 60384-14 275 V AC	 IEC 60384-14 275 V AC
0.01	20	10.5	9	4	7.5	0.6	●	●	
0.015	20	10.5	9	4	7.5	0.6	●	●	
0.022	20	10.5	9	4	7.5	0.6	●	●	
0.033	20	10.5	10	5	7.5	0.6	●	●	
0.047	20	10.5	11	5.5	7.5	0.6	●	●	
0.068	20	13	11	5.5	10	0.6	●	●	
0.1	20	13	12	6	10	0.6	●	●	
0.1	10, 20	18	11	5	15	0.8	●	●	
0.12	20	18	11	5	15	0.8	●	●	
0.12	10, 20	18	11	5.5	15	0.8	●	●	
0.15	20	18	11	5.5	15	0.8	●	●	
0.15	10, 20	18	12	6	15	0.8	●	●	
0.18	10, 20	18	12	6	15	0.8	●	●	
0.22	20	18	12.5	6.5	15	0.8	●	●	
0.22	10, 20	18	13	7	15	0.8	●	●	
0.27	20	18	13	7	15	0.8	●	●	
0.27	10, 20	18	13.5	7.5	15	0.8	●	●	
0.33	10, 20	18	16	7.5	15	0.8	●	●	
0.33	10, 20	18	14.5	8.2	15	0.8	●	●	
0.39	20	18	19.5	7.5	15	0.8	●	●	
0.39	10, 20	18	16.5	8.5	15	0.8	●	●	
0.47	20	18	16	9.5	15	0.8	●	●	
0.47	10, 20	18	18.5	9	15	0.8	●	●	
0.56	20	18	18.5	9	15	0.8	●	●	
0.56	10, 20	18	19	10	15	0.8	●	●	
0.56	10, 20	18	18.5	11	15	0.8	●	●	
0.68	20	18	18.5	11	15	0.8	●	●	
0.68	10, 20	18	22	10	15	0.8	●	●	
0.68	10, 20	18	20	11	15	0.8	●	●	
0.68	10, 20	18	20	12.5	15	0.8	●	●	

\* MINI SIZE MARKING WITH  EXCEPT PCM 7.5 mm

- APPROVALS IN USE
- APPROVALS IN PENDING

# CAPACITORS

## TYPE KNB1560, KNB1562, KNB1563

**CLASS X2**  
300 V AC  
+125 °C

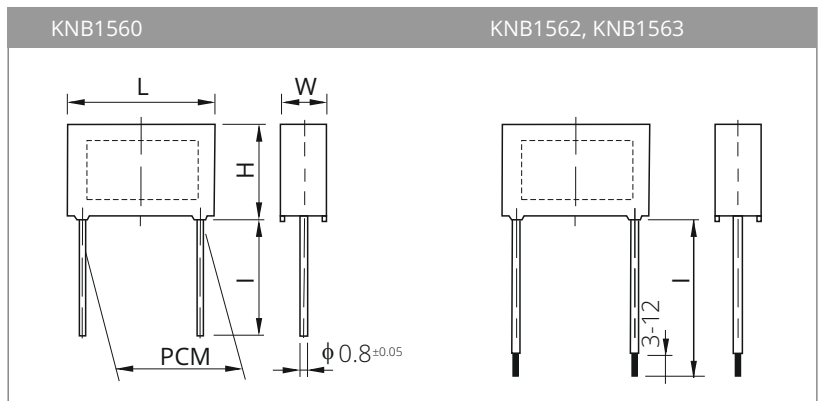
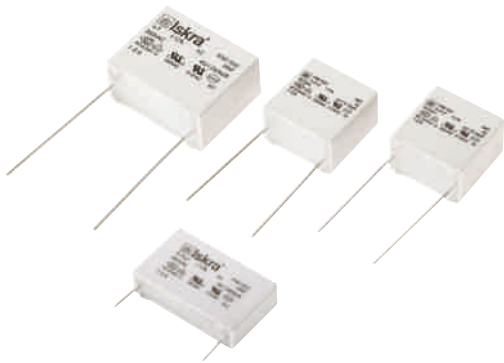

### ELECTRICAL CONNECTION

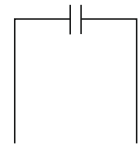

### TECHNICAL DATA

■ CONSTRUCTION	POLYPROPYLENE FILM, METALLIZED
■ RATED VOLTAGE	300 V AC
■ CAPACITANCE TOLERANCE	± 20 % FOR C ≤ 0.1 μF ± 10 % FOR C > 0.1 μF
■ CLIMATIC CATEGORY	40/100/56 ACC. TO IEC 60068-1
■ PASSIVE FLAMMABILITY	ACC. TO IEC 60384-14
■ TEMPERATURE RANGE	-40 ° to +125 °C
■ TEST VOLTAGE	2200 V DC, 1 s FOR C ≤ 1 μF 1900 V DC, 1 s FOR C > 1 μF
■ MAX. PULSE RISE TIME du/dt, AT 390 V DC	500 V / μs FOR PCM > 1 μF 400 V / μs FOR PCM = 15 mm C > 0.022 μF 250 V / μs FOR PCM = 15 mm C > 0.022 μF 150 V / μs FOR PCM = 22.5 mm 100 V / μs FOR PCM = 27.5 mm
■ INSULATION RESISTANCE AT 20 °C, U <sub>m</sub> = 100 V DC, t = 1 min	R <sub>i</sub> ≥ 15000 MΩ FOR C ≤ 0.33 μF R <sub>x</sub> C <sub>n</sub> ≥ 5000 s FOR C > 0.33 μF
■ DIELECTRIC LOSS TANδ AT F = 1 kHz AND 20 °C	≤ 1 x 10 <sup>-3</sup>
■ SOLDERING	IEC 60068-2-20, max. 2 s
■ RESISTANCE TO SOLDERING HEAT	IEC 60068-2-20, 260 °C ± 5 °C, 10 s ± 1 s
■ SELF INDUCTANCE	APPROX. 10 nH/cm OF CAPACITOR LENGTH AND TERMINALS
■ COMPLIES TO	IEC 60384-14, UL 60384-14 CSA 60384-14
■ APPLICATION	RFI SUPPRESSION CLASS X2 (ACROSS-THE-LINE CONNECTION) CAPACITOR IS AVAILABLE IN CD VERSION SUITABLE FOR SERIES CONNECTION TO THE SUPPLY MAINS (CAPACITIVE POWER SUPPLY)

# CAPACITORS

## TYPE KNB1560, KNB1562, KNB1563

CASING: THERMOPLASTIC (PP OR ON REQUEST PBT HF) SEALED WITH SYNTHETICAL RESIN	THERMOPLASTIC MATERIAL AND SYNTHETICAL RESIN ARE SELF-EXTINGUISHING ACCORDING TO UL 94. CLASS V-0.	
TERMINALS		
TYPE	TERMINAL LENGHT	TYPE OF TERMINALS
KNB1560	3 <sup>+0.5</sup> , 4 <sup>+0.5</sup> , 6 <sup>-1</sup> , 9 <sup>+1</sup> , 15 <sup>+2</sup> , 20 <sup>+2</sup> , 25 <sup>+5</sup> , 30 <sup>+5</sup> , 50 <sup>+5</sup> mm, OTHER ON REQUEST	TINNED COPPER WIRE
KNB1562	20 TO 200 mm	INSULATED STRANDED WIRE 0.5 mm <sup>2</sup>
KNB1563	20 TO 200 mm	INSULATED SOLID WIRE $\phi$ 0.8 mm, TERMINAL ENDS ON REQUEST

### STANDARD VALUES KNB1560, KNB1562, KNB1563, 300 V AC, CLASS X2, +125 °C

CAPACITANCE C (μF)	DIMENSIONS					 IEC 60384-14 300 V AC	FOR CAPACITORS WITH INSULATED LEADS ON REQUEST	
	L (mm)	H (mm)	W (mm)	PCM (mm)	ø (mm)		 UL 60384-14 CSA 60384-14 300 V AC	 IEC 60384-14 300 V AC
0.01	13	9	4	10	0.6	●	●	●
0.015	13	9	4	10	0.6	●	●	●
0.022	13	9	4	10	0.6	●	●	●
0.033	13	9	4	10	0.6	●	●	●
0.033	13	10.5	5	10	0.6	●	●	●
0.047	13	10.5	5	10	0.6	●	●	●
0.047	13	11.5	6	10	0.6	●	●	●
0.068	13	11	5.5	10	0.6	●	●	●
0.1	13	12	6	10	0.6	●	●	●
0.01	18	11	5	15	0.8	●	●	●
0.015	18	11	5	15	0.8	●	●	●
0.022	18	11	5	15	0.8	●	●	●
0.033	18	11	5	15	0.8	●	●	●
0.047	18	11	5	15	0.8	●	●	●
0.068	18	11	5	15	0.8	●	●	●
0.1	18	11	5.5	15	0.8	●	●	●
0.12	18	12	6	15	0.8	●	●	●
0.15	18	13	7	15	0.8	●	●	●
0.22	18	14.5	8.2	15	0.8	●	●	●
0.27	18	14.5	9	15	0.8	●	●	●
0.33	18	16	9.5	15	0.8	●	●	●
0.33	18	19.5	7.5	15	0.8	●	●	●
0.47	18	18.5	11	15	0.8	●	●	●
0.56	18	20	12.5	15	0.8	●	●	●
0.15	26.5	14	6	22.5	0.8	●	●	●
0.22	26.5	14	6	22.5	0.8	●	●	●
0.27	26.5	15	6	22.5	0.8	●	●	●
0.33	26.5	16	7	22.5	0.8	●	●	●
0.47	26.5	17	8.5	22.5	0.8	●	●	●
0.56	26.5	18.5	9	22.5	0.8	●	●	●
0.68	26.5	18.5	10	22.5	0.8	●	●	●
1	26.5	21.5	12.5	22.5	0.8	●	●	●
0.47	31.5	16	7.5	27.5	0.8	●	●	●
0.56	32	17	9	27.5	0.8	●	●	●
0.68	32	17	9	27.5	0.8	●	●	●
1	32	20	11	27.5	0.8	●	●	●
1.5	31.5	23.5	14	27.5	0.8	●	●	●
2.2	31.5	26.5	17	27.5	0.8	●	●	●

● APPROVALS IN USE

# CAPACITORS WITH DISCHARGE RESISTOR TYPE KNB1560, KNB1562, KNB1563

CLASS X2

275 V AC

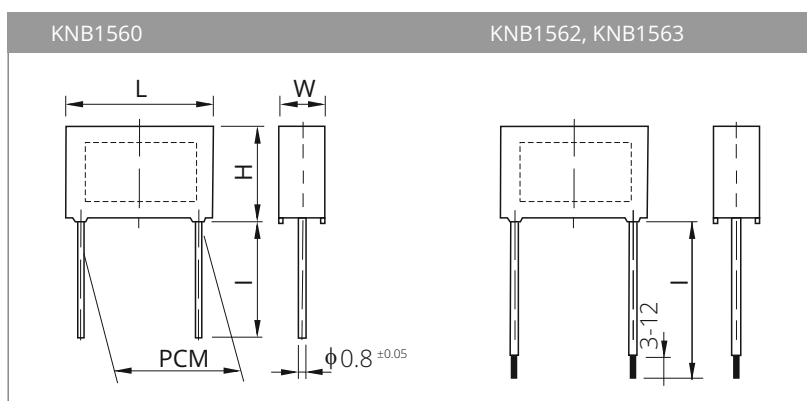
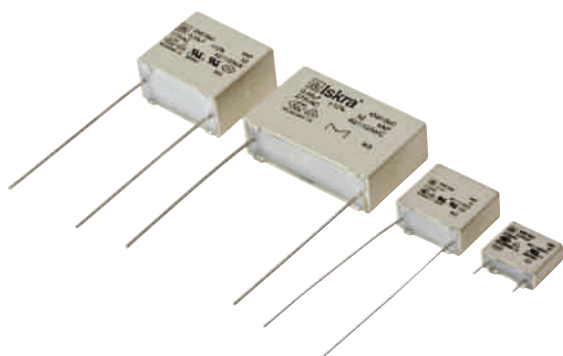

## ELECTRICAL CONNECTION

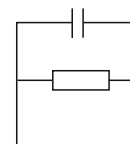

## TECHNICAL DATA

■ CONSTRUCTION: - CAPACITOR - RESISTOR	POLYPROPYLENE FILM, METALLIZED METALOXIDE FILM
■ RATED VOLTAGE	275 V AC
■ CAPACITANCE TOLERANCE	$\pm 20\%$ FOR $C \leq 0.1 \mu\text{F}$ $\pm 10\%$ FOR $C > 0.1 \mu\text{F}$
■ RESISTANCE TOLERANCE	$\pm 5\%$
■ RESISTANCE POWER	0.6 W
■ CLIMATIC CATEGORY	40/100/56 ACC. TO IEC 60068-1
■ PASSIVE FLAMMABILITY	ACC. TO IEC 60384-14
■ TEMPERATURE RANGE	-40 ° to +110 °C
■ TEST VOLTAGE	1700 V DC, 1 s
■ MAX. PULSE RISE TIME $du/dt$ , AT 390 V DC	250 V / $\mu\text{s}$ FOR PCM = 15 mm 150 V / $\mu\text{s}$ FOR PCM = 22.5 mm
■ SOLDERING	IEC 60068-2-20, MAX. 2 s
■ RESISTANCE TO SOLDERING HEAT	IEC 60068-2-20, 260 °C $\pm 5$ °C, 10 s $\pm 1$ s
■ SELF INDUCTANCE	APPROX. 10 nH/cm OF CAPACITOR LENGTH AND TERMINALS
■ COMPLIES TO	IEC 60384-14, UL 60384-14, CSA 60384-14
■ APPLICATION	RFI SUPPRESSION CLASS X2 (ACROSS-THE-LINE CONNECTION) CAPACITOR IS AVAILABLE IN CD VERSION SUITABLE FOR SERIES CONNECTION TO THE SUPPLY MAINS (CAPACITIVE POWER SUPPLY)





# CAPACITORS WITH DISCHARGE RESISTOR

## TYPE KNB1560, KNB1562, KNB1563

CASING: THERMOPLASTIC (PP OR ON REQUEST PBT HF) SEALED WITH SYNTHETICAL RESIN	THERMOPLASTIC MATERIAL AND SYNTHETICAL RESIN ARE SELF-EXTINGUISHING ACCORDING TO UL 94. CLASS V-0.	
TERMINALS		
TYPE	TERMINAL LENGHT	TYPE OF TERMINALS
KNB1560	3 <sup>+0.5</sup> , 4 <sup>+0.5</sup> , 6 <sup>-1</sup> , 9 <sup>+1</sup> , 15 <sup>+2</sup> , 20 <sup>+2</sup> , 25 <sup>+5</sup> , 30 <sup>+5</sup> , 50 <sup>+5</sup> mm, OTHER ON REQUEST	TINNED COPPER WIRE
KNB1562	20 TO 200 mm	INSULATED STRANDED WIRE 0.5 mm <sup>2</sup>
KNB1563	20 TO 200 mm	INSULATED SOLID WIRE $\phi$ 0.8 mm, TERMINAL ENDS ON REQUEST

### STANDARD VALUES KNB1560, KNB1562, KNB1563, 275 V AC, CLASS X2, WITH DISCHARGE RESISTOR

CAPACITANCE C ( $\mu$ F)	RESISTANCE R (K $\Omega$ )	DIMENSIONS				 IEC 60384-14 275 V AC	FOR CAPACITORS WITH INSULATED LEADS ON REQUEST	
		L (mm)	H (mm)	W (mm)	PCM (mm)		 UL 60384-14 CSA 60384-14 275 V AC	 IEC 60384-14 275 V AC
0.047	470 TO 2700	18	12	6	15	●	●	●
0.068		18	12	6	15	●	●	●
0.1		18	13	7	15	●	●	●
0.15		18	14.5	8.2	15	●	●	●
0.22		18	16.5	8.5	15	●	●	●
0.33		18	18.5	11	15	●	●	●
0.33		26.5	16.5	8.5	22.5	●	●	●
0.47	26.5	18.5	9	22.5	●	●	●	

RESISTANCE VALUES ACCORDING TO IEC 60063 RANGE E12.

● APPROVALS IN USE

# CAPACITORS

## TYPE KNB1580, KNB1582, KNB1583

**CLASS X2**  
305 V AC  
310 V AC

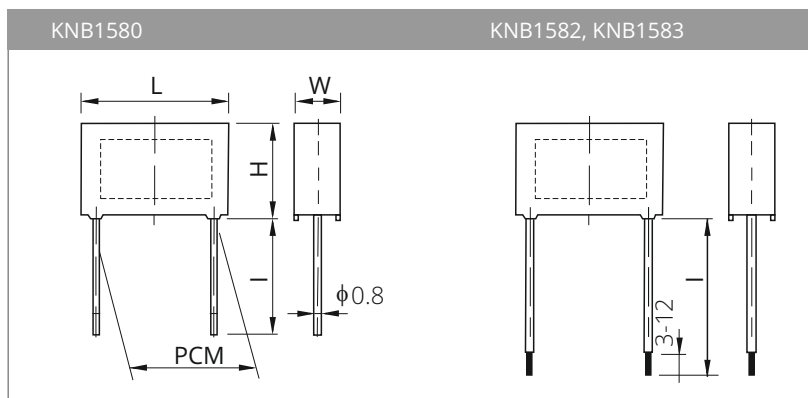
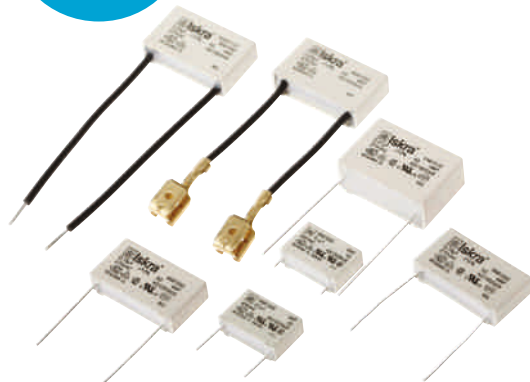

### ELECTRICAL CONNECTION

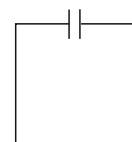

### TECHNICAL DATA



■ CONSTRUCTION	POLYPROPYLENE FILM, METALLIZED
■ RATED VOLTAGE	305 V AC, 310 V AC
■ CAPACITANCE TOLERANCE	± 20 % FOR $C \leq 0.1 \mu\text{F}$ ± 10 % FOR $C > 0.1 \mu\text{F}$
■ CLIMATIC CATEGORY	40/110/56 ACC. TO IEC 60068-1
■ PASSIVE FLAMMABILITY	CATEGORY B ACC. TO IEC 60384-14
■ TEMPERATURE RANGE	-40 ° to +110 °C
■ TEST VOLTAGE	2200 V DC, 1 s FOR $C \leq 1 \mu\text{F}$ 1900 V DC, 1 s FOR $1 \mu\text{F} < C \leq 2.2 \mu\text{F}$ 1600 V DC, 2 s FOR $C > 2.2 \mu\text{F}$
■ MAX. PULSE RISE TIME $du/dt$ , AT 438 V DC	500 V/ $\mu\text{s}$ FOR PCM = 10 mm 400 V/ $\mu\text{s}$ FOR PCM = 15 mm AND $C \leq 0.022 \mu\text{F}$ 250 V/ $\mu\text{s}$ FOR PCM = 15 mm AND $C \leq 0.022 \mu\text{F}$ 150 V/ $\mu\text{s}$ FOR PCM = 22.5 mm 100 V/ $\mu\text{s}$ FOR PCM = 27.5 mm 100 V/ $\mu\text{s}$ FOR PCM = 37.5 mm
■ INSULATION RESISTANCE AT 20 °C, $U_m = 100 \text{ V DC}$ , $t = 1 \text{ min}$	$R_i \geq 15000 \text{ M}\Omega$ FOR $C \leq 0.33 \mu\text{F}$ $R_i \times C_n \geq 5000 \text{ s}$ FOR $C > 0.33 \mu\text{F}$
■ DIELECTRIC LOSS $\tan\delta$ AT $F = 1 \text{ kHz}$ , 20 °C	$\leq 10 \times 10^{-4}$
■ SOLDERING	IEC 60068-2-20, MAX. 2 s
■ RESISTANCE TO SOLDERING HEAT	IEC 60068-2-20, 260 °C ± 5 °C, 10 s ± 1 s
■ SELF INDUCTANCE	APPROX. 10 nH/cm OF CAPACITOR LENGTH AND TERMINALS
■ COMPLIES TO	IEC 60384-14, UL 60384-14 CSA 60384-14
■ APPLICATION	RFI SUPPRESSION CLASS X2 (ACROSS-THE-LINE CONNECTION) SUITABLE FOR SERIES CONNECTION TO THE SUPPLY MAINS (CAPACITIVE POWER SUPPLY)

# CAPACITORS

## TYPE KNB1580, KNB1582, KNB1583

CASING: THERMOPLASTIC (PP OR ON REQUEST PBT HF) SEALED WITH SYNTHETICAL RESIN	THERMOPLASTIC MATERIAL AND SYNTHETICAL RESIN ARE SELF-EXTINGUISHING ACCORDING TO UL 94. CLASS V-0.
<b>TERMINALS</b>	
TYPE	TERMINAL LENGHT
KNB1580	4 <sup>±0.5</sup> , 6 <sup>-1</sup> , 25 <sup>±5</sup> , OTHER ON REQUEST
KNB1582	20 TO 200 mm
KNB1583	20 TO 200 mm
	TYPE OF TERMINALS
	TINNED COPPER WIRE
	INSULATED STRANDED WIRE 0.5 mm <sup>2</sup>
	INSULATED SOLID WIRE $\phi$ 0.8 mm, TERMINAL ENDS ON REQUEST

### STANDARD VALUES KNB1580, KNB1582, KNB1583, 305 V AC, 310 V AC, CLASS X2

CAPACITANCE C (µF)	DIMENSIONS					 IEC 60384-14 310 V AC	FOR CAPACITORS WITH INSULATED LEADS ON REQUEST	
	L (mm)	H (mm)	W (mm)	PCM (mm)	$\phi$ (mm)		 UL 60384-14 CSA 60384-14 305/310 V AC	 IEC 60384-14 310 V AC
0.01	13	9	4	10	0.6	●	●	●
0.015	13	9	4	10	0.6	●	●	●
0.022	13	9	4	10	0.6	●	●	●
0.033	13	9	4	10	0.6	●	●	●
0.033	13	10.5	5	10	0.6	●	●	●
0.047	13	10.5	5	10	0.6	●	●	●
0.047	13	11.5	6	10	0.6	●	●	●
0.068	13	11	5.5	10	0.6	●	●	●
0.1	13	12	6	10	0.6	●	●	●
0.01	18	11	5	15	0.8	●	●	●
0.015	18	11	5	15	0.8	●	●	●
0.022	18	11	5	15	0.8	●	●	●
0.033	18	11	5	15	0.8	●	●	●
0.047	18	11	5	15	0.8	●	●	●
0.068	18	11	5	15	0.8	●	●	●
0.1	18	11	5.5	15	0.8	●	●	●
0.12	18	12	6	15	0.8	●	●	●
0.15	18	13	7	15	0.8	●	●	●
0.22	18	14.5	8.2	15	0.8	●	●	●
0.27	18	14.5	9	15	0.8	●	●	●
0.33	18	16	9.5	15	0.8	●	●	●
0.33	18	19.5	7.5	15	0.8	●	●	●
0.47	18	18.5	11	15	0.8	●	●	●
0.56	18	20	12.5	15	0.8	●	●	●
0.15	26.5	14	6	22.5	0.8	●	●	●
0.22	26.5	14	6	22.5	0.8	●	●	●
0.27	26.5	15	6	22.5	0.8	●	●	●
0.33	26.5	16	7	22.5	0.8	●	●	●
0.47	26.5	17	8.5	22.5	0.8	●	●	●
0.56	26.5	18.5	9	22.5	0.8	●	●	●
0.68	26.5	18.5	10	22.5	0.8	●	●	●
1	26.5	21.5	12.5	22.5	0.8	●	●	●
0.47	31.5	16	7.5	27.5	0.8	●	●	●
0.56	32	17	9	27.5	0.8	●	●	●
0.68	32	17	9	27.5	0.8	●	●	●
1	32	20	11	27.5	0.8	●	●	●
1.5	31.5	23.5	14	27.5	0.8	●	●	●
2.2	31.5	26.5	17	27.5	0.8	●	●	●
2.7	31.5	32	18	27.5	0.8	●	●	●
3.3	31.5	32	18	27.5	0.8	●	●	●
3.3	31.5	33	20	27.5	0.8	●	●	●
3.9	31.5	33	20	27.5	0.8	●	●	●
4.7	32	39	24	27.5	0.8	●	●	●
5.6	32	39	24	27.5	0.8	●	●	●
1.5	41.5	22	14	37.5	0.8	●	●	●
2.2	41.5	23	14	37.5	0.8	●	●	●
3.3	41.5	26	18	37.5	0.8	●	●	●
3.9	41.5	31	18	37.5	0.8	●	●	●
4.7	41.5	32	19	37.5	0.8	●	●	●
5.6	41.5	38	21	37.5	1	●	●	●
6.8	41.5	38	21	37.5	1	●	●	●
8.2	41.5	43	28	37.5	1	●	●	●
10	41.5	43	28	37.5	1	●	●	●
10	42	45	30	37.5	1	●	●	●
15	42	50	36	37.5	1	●	●	●

● APPROVALS IN USE

# CAPACITORS

## TYPE KNR1530, KNR1532, KNR1533

CLASS X2  
RC UNITS  
275 V AC

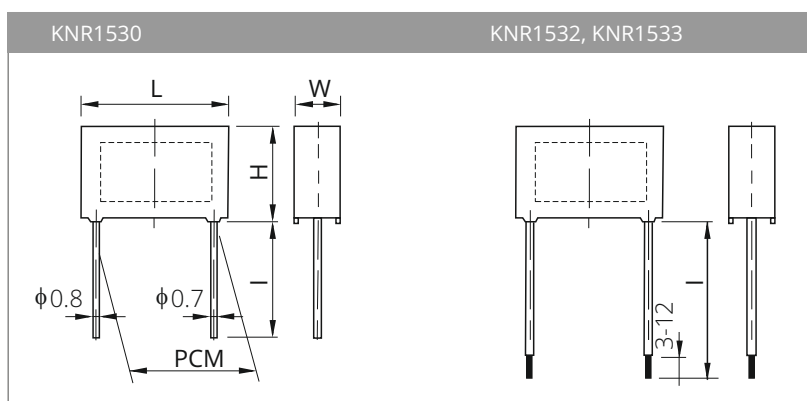
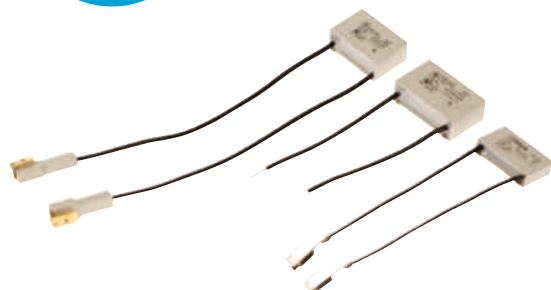

### ELECTRICAL CONNECTION

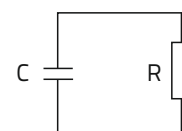

### TECHNICAL DATA

■ CONSTRUCTION: - CAPACITOR - RESISTOR	POLYPROPYLENE FILM, METALLIZED CARBON FILM OR WIRE-WOUND
■ RATED VOLTAGE	275 V AC
■ CAPACITANCE TOLERANCE	± 20 % FOR $C \leq 0.1 \mu\text{F}$ ± 10 % FOR $C > 0.1 \mu\text{F}$ OTHER ON REQUEST
■ CLIMATIC CATEGORY	40/100/56 ACC. TO IEC 60068-1
■ PASSIVE FLAMMABILITY	ACC. TO IEC 60384-14
■ TEMPERATURE RANGE	-40 ° to +85 °C
■ TEST VOLTAGE	1700 V DC, 2 s
■ INSULATION RESISTANCE AT 20 °C, $U_m = 100 \text{ V DC}, t = 1 \text{ min}$	$R_i \geq 15000 \text{ M}\Omega$ FOR $C \leq 0.33 \mu\text{F}$ $R_i \times C_n \geq 5000 \text{ s}$ FOR $C > 0.33 \mu\text{F}$
■ RESISTANCE TOLERANCE	± 10 %
■ RESISTOR POWER	0.5 W
■ SOLDERING	IEC 60068-2-20, MAX. 2 s
■ RESISTANCE TO SOLDERING HEAT	IEC 60068-2-20, 260 °C ± 5 °C, 10 s ± 1 s
■ COMPLIES TO	IEC 60384-14
■ APPLICATION	CONTACT PROTECTION, INTERFERENCE SUPPRESSION, TRANSIENT SUPPRESSION

# CAPACITORS

## TYPE KNR1530, KNR1532, KNR1533

CASING: THERMOPLASTIC SEALED WITH SYNTHETICAL RESIN	THERMOPLASTIC MATERIAL IS SELF-EXTINGUISHING ACCORDING TO UL 94. CLASS V-0.	
TERMINALS		
TYPE	TERMINAL LENGTH	TYPE OF TERMINALS
KNR1530	3 <sup>+0.5</sup> , 4 <sup>+0.5</sup> , 6 <sup>-1</sup> , 9 <sup>+1</sup> , 15 <sup>+2</sup> , 20 <sup>+2</sup> , 25 <sup>+5</sup> , 30 <sup>+5</sup> , 50 <sup>+5</sup> mm, OTHER ON REQUEST	TINNED COPPER WIRE
KNR1532	20 TO 200 mm	INSULATED STRANDED WIRE 0.5 mm <sup>2</sup>
KNR1533	20 TO 200 mm	INSULATED SOLID WIRE $\phi$ 0.8 mm, TERMINAL ENDS ON REQUEST

### STANDARD VALUES KNR1530, KNR1532, KNR1533, 275 V AC, CLASS X2

CAPACITANCE C ( $\mu$ F)	RESISTANCE R ( $\Omega$ )	DIMENSIONS					
		L (mm)	H (mm)	W (mm)	PCM (mm)		
0.01	2.2 TO 470	21	16.5	8	17.5	●	
0.01		27	15	8	22.5	●	
0.015		21	16.5	8	17.5	●	
0.015		27	15	6	22.5	●	
0.022		21	16.5	8	17.5	●	
0.022		27	15	6	22.5	●	
0.033		21	16.5	8	17.5	●	
0.033		27	15	6	22.5	●	
0.047		21	16.5	8	17.5	●	
0.047		27	15	6	22.5	●	
0.068		21	16.5	8	17.5	●	
0.068		27	15	6	22.5	●	
0.1		21	16.5	8	17.5	●	
0.1		27	16.5	7	22.5	●	
0.15		27	17	8.5	22.5	●	
0.15		30	18	8	25	●	
0.22		27	19	10.5	22.5	●	
0.22		30	18	8	25	●	
0.27		2.2 TO 330	32	19	10	27.5	●
0.33		2.2 TO 220	32	19	10	27.5	●
0.47	32		20	11	27.5	●	

RESISTANCE VALUES ACCORDING TO IEC 60063 RANGE E12.

● APPROVALS IN USE

# CAPACITORS

## TYPE KNB2520, KNB2522, KNB2523

**CLASS Y2**  
250 V AC  
300 V AC

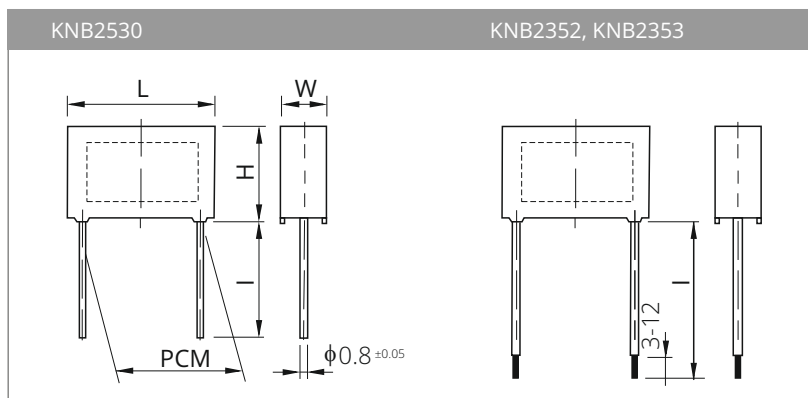
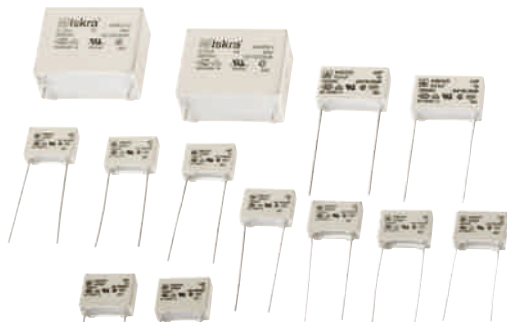

### ELECTRICAL CONNECTION

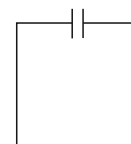

### TECHNICAL DATA

■ CONSTRUCTION	POLYPROPYLENE FILM, METALLIZED
■ RATED VOLTAGE	250 V AC, 300 V AC
■ CAPACITANCE TOLERANCE	± 10 % , ± 20 %
CLIMATIC CATEGORY	40/100/56 ACC. TO IEC 60068-1
■ PASSIVE FLAMMABILITY	ACC. TO IEC 60384-14
■ TEMPERATURE RANGE	-40 ° to +100 °C
■ TEST VOLTAGE	4000 V DC, 1 s
■ MAX. PULSE RISE TIME du/dt, AT 425 V DC	3000 V / μs FOR 1000 pF 2500 V / μs FOR 1500 pF 2000 V / μs FOR 2200 pF UP TO 6800 pF PCM10 1000 V / μs FOR PCM ≥ 15 100 V / μs FOR PCM = 27.5 mm ACC. TO IEC 60384-14
■ INSULATION RESISTANCE AT 20 °C , U <sub>m</sub> = 100 V DC, t = 1 min	R <sub>i</sub> ≥ 15000 MΩ
■ DIELECTRIC LOSS TANδ AT F = 1 kHz AND 20 °C	≤ 15 × 10 <sup>-4</sup>
■ SOLDERING	IEC 60068-2-20, MAX. 2 s
■ RESISTANCE TO SOLDERING HEAT	IEC 60068-2-20, 260 °C ± 5 °C, 10 s ± 1 s
■ SELF INDUCTANCE	APPROX. 10 nH/cm OF CAPACITOR LENGTH AND TERMINALS
■ COMPLIES TO	IEC 60384-14, UL 60384-14 CSA 60384-14
■ APPLICATION	RFI SUPPRESSION CLASS Y2 (LINE TO GROUND CONNECTION)

# CAPACITORS

## TYPE KNB2520, KNB2522, KNB2523

CASING: THERMOPLASTIC (PP OR ON REQUEST PBT HF) SEALED WITH SYNTHETICAL RESIN	THERMOPLASTIC MATERIAL AND SYNTHETICAL RESIN ARE SELF-EXTINGUISHING ACCORDING TO UL 94. CLASS V-0.	
TERMINALS		
TYPE	TERMINAL LENGTH	TYPE OF TERMINALS
KNB2520	$3^{+0.5}$ , $4^{+0.5}$ , $6^{-1}$ , $9^{+1}$ , $15^{+2}$ , $20^{+2}$ , $25^{+5}$ , $30^{+5}$ , $50^{+5}$ mm, OTHER ON REQUEST	TINNED COPPER WIRE
KNB2522	20 TO 200 mm	INSULATED STRANDED WIRE 0.5 mm <sup>2</sup>
KNB2523	20 TO 200 mm	INSULATED SOLID WIRE $\phi$ 0.8 mm, TERMINAL ENDS ON REQUEST

### STANDARD VALUES KNB2520, KNB2522, KNB2523, 250 V AC, 300 V AC, CLASS Y2

CAPACITANCE C (pF)	DIMENSIONS					 IEC 60384-14 300 V AC	FOR CAPACITORS WITH INSULATED LEADS ON REQUEST	
	L (mm)	H (mm)	W (mm)	PCM (mm)	$\phi$ (mm)		 UL 60384-14 CSA 60384-14 275 V AC/300 V AC	 IEC 60384-14 300 V AC
1000	13	9.5	4.3	10	0.6	●	●	●
1500	13	9.5	4.3	10	0.6	●	●	●
2200	13	9.5	4.3	10	0.6	●	●	●
2500	13	9.5	4.3	10	0.6	●	●	●
2700	13	9.5	4.3	10	0.6	●	●	●
2800	13	9.5	4.3	10	0.6	●	●	●
3300	13	10.5	5	10	0.6	●	●	●
4700	13	11.5	6	10	0.6	●	●	●
5000	13	11.5	6	10	0.6	●	●	●
6800	13	12	6	10	0.6	●	●	●
6800	18	11	5.5	15	0.8	●	●	●
10000	18	11	5.5	15	0.8	●	●	●
15000	18	12	6	15	0.8	●	●	●
22000	18	13	7	15	0.8	●	●	●
25000	18	13.5	7.5	15	0.8	●	●	●
27000	18	13.5	7.5	15	0.8	●	●	●
33000	18	14.5	9	15	0.8	●	●	●
39000	18	18.5	9	15	0.8	●	●	●
47000	18	18.5	9	15	0.8	●	●	●
33000	26.5	14	6	22.5	0.8	●	●	●
39000	26.5	15	6	22.5	0.8	●	●	●
47000	26.5	16	7	22.5	0.8	●	●	●
56000	26.5	16.5	8.5	22.5	0.8	●	●	●
68000	26.5	17	8.5	22.5	0.8	●	●	●
100000	27	19	10.5	22.5	0.8	●	●	●
120000	26.5	20.5	11	22.5	0.8	●	●	●
150000	26.5	21.5	12.5	22.5	0.8	●	●	●

● APPROVALS IN USE

# CAPACITORS

## TYPE KNB2530, KNB2532, KNB2533

CLASS Y1

440 V AC

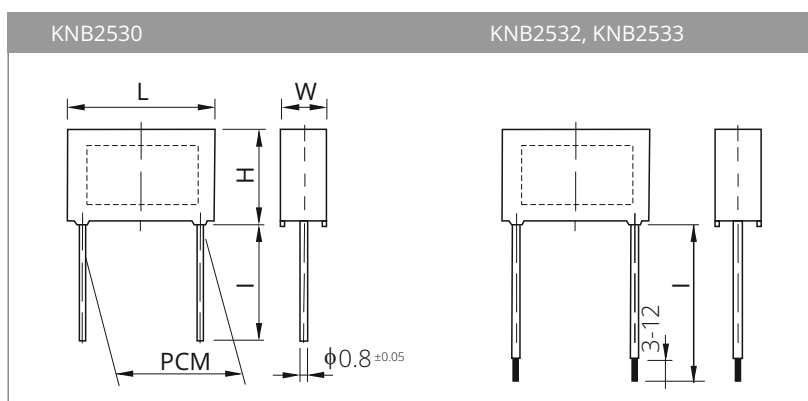
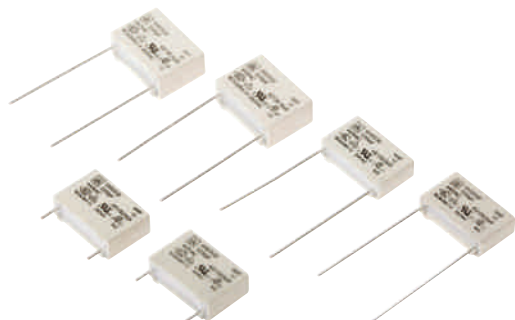

### TECHNICAL DATA

■ CONSTRUCTION	POLYPROPYLENE FILM, METALLIZED
■ RATED VOLTAGE	440 V AC
■ CAPACITANCE TOLERANCE	$\pm 10\%$ , $\pm 20\%$
■ CLIMATIC CATEGORY	40/100/56 ACC. TO IEC 60068-1
■ PASSIVE FLAMMABILITY	ACC. TO IEC 60384-14
■ TEMPERATURE RANGE	-40 ° TO +100 °C
■ TEST VOLTAGE	4000 V AC, 2 s
■ MAX. PULSE RISE TIME du/dt, AT 622 V DC	6000 V / $\mu$ s FOR PCM = 15 mm 3500 V / $\mu$ s FOR PCM = 22.5 mm ACC. TO IEC 60384-14
■ INSULATION RESISTANCE AT 20 °C , $U_m = 100$ V DC, t = 1 min	$R_i \geq 15000$ M $\Omega$
■ DIELECTRIC LOSS TAN $\delta$ AT F = 1 kHz AND 20 °C	$\leq 16 \times 10^{-4}$
■ SOLDERING	IEC 60068-2-20, max. 2 s
■ RESISTANCE TO SOLDERING HEAT	IEC 60068-2-20, 260 °C $\pm$ 5 °C, 10 s $\pm$ 1 s
■ SELF INDUCTANCE	APPROX. 10 nH/cm OF CAPACITOR LENGTH AND TERMINALS
■ COMPLIES TO	IEC 60384-14, UL 60384-14 CSA 60384-14
■ PERMISSIBLE CONTINUOUS AC VOLTAGE	750 V , 50/60 Hz
■ PERMISSIBLE CONTINUOUS DC VOLTAGE	3000 V
■ APPLICATION	RFI SUPPRESSION CLASS Y1 (LINE TO GROUND CONNECTION)

### ELECTRICAL CONNECTION

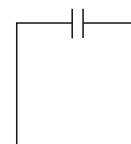





# CAPACITORS

## TYPE KNB2530, KNB2532, KNB2533

CASING: THERMOPLASTIC (PP OR ON REQUEST PBT HF) SEALED WITH SYNTHETICAL RESIN	THERMOPLASTIC MATERIAL AND SYNTHETICAL RESIN ARE SELF-EXTINGUISHING ACCORDING TO UL 94. CLASS V-0.	
TERMINALS		
TYPE	TERMINAL LENGHT	TYPE OF TERMINALS
KNB2530	3 <sup>+0.5</sup> , 4 <sup>+0.5</sup> , 6 <sup>-1</sup> , 9 <sup>+1</sup> , 15 <sup>+2</sup> , 20 <sup>+2</sup> , 25 <sup>+5</sup> , 30 <sup>+5</sup> , 50 <sup>+5</sup> mm, OTHER ON REQUEST	TINNED COPPER WIRE
KNB2532	20 TO 200 mm	INSULATED STRANDED WIRE 0.5 mm <sup>2</sup>
KNB2533	20 TO 200 mm	INSULATED SOLID WIRE $\phi$ 0.8 mm , TERMINAL ENDS ON REQUEST

### STANDARD VALUES KNB2530, KNB2532, KNB2533, 440 V AC, CLASS Y1

CAPACITANCE C (pF)	DIMENSIONS					 IEC 60384-14 440 V AC	 UL 60384-14 CSA 60384-14 440 V AC	 IEC 60384-14 440 V AC
	L (mm)	H (mm)	W (mm)	PCM (mm)	$\phi$ (mm)			
470	18	11	5	15	0.8	●	●	●
680	18	11	5	15	0.8	●	●	●
1000	18	11	5	15	0.8	●	●	●
1500	18	11	5	15	0.8	●	●	●
2200	18	12	6	15	0.8	●	●	●
2700	18	13	7	15	0.8	●	●	●
2800	18	13	7	15	0.8	●	●	●
3300	18	13	7	15	0.8	●	●	●
4700	18	14.5	8.2	15	0.8	●	●	●
5000	18	14.5	8.2	15	0.8	●	●	●
5600	18	16.5	8.5	15	0.8	●	●	●
6800	18	18.5	9	15	0.8	●	●	●
10000	18	20	12.5	15	0.8	●	●	●
5600	26.5	14	6	22.5	0.8	●	●	●
6800	26.5	16	7	22.5	0.8	●	●	●
10000	26.5	16.5	8.5	22.5	0.8	●	●	●
15000	26.5	18.5	10	22.5	0.8	●	●	●
22000	26.5	21.5	12.5	22.5	0.8	●	●	●

● APPROVALS IN USE

**NOTE:**  
APPROVAL CQC ONLY FOR PBT HF CASE.

# CAPACITORS

## TYPE KNB1540, KNB1542, KNB1543

CLASS X1

440 V AC

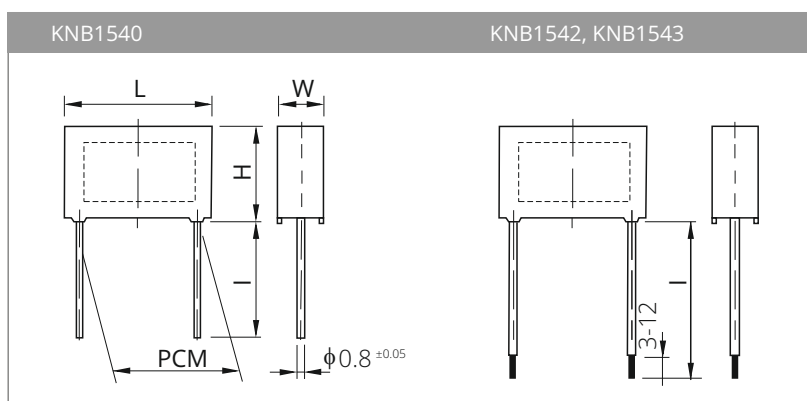
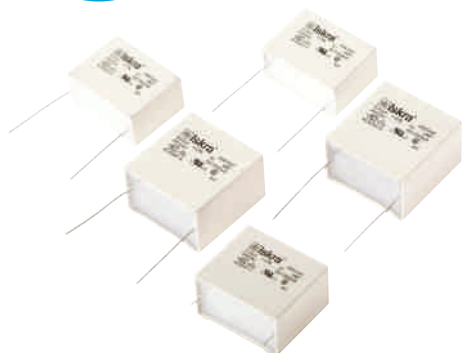

### ELECTRICAL CONNECTION

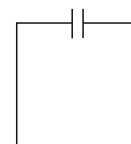

### TECHNICAL DATA

■ CONSTRUCTION	POLYPROPYLENE FILM, METALLIZED
■ RATED VOLTAGE	440 V AC
■ CAPACITANCE TOLERANCE	± 20 % FOR C ≤ 0.1 μF ± 10 % FOR C > 0.1 μF
■ CLIMATIC CATEGORY	40/100/56 ACC. TO IEC 60068-1
■ PASSIVE FLAMMABILITY	ACC. TO IEC 60384-14
■ TEMPERATURE RANGE	-40 °C TO +100 °C
■ TEST VOLTAGE	3500 V DC, 1 s
■ MAX. PULSE RISE TIME du/dt, AT 622 V DC	3000 V / μs FOR PCM = 15 mm 1500 V / μs FOR PCM = 22.5 mm 1100 V / μs FOR PCM = 27.5 mm ACC. TO IEC 60384-14
■ INSULATION RESISTANCE AT 20 °C , U <sub>m</sub> = 100 V DC, t = 1 min	R <sub>i</sub> ≥ 15000 MΩ FOR C ≤ 0.33 μF R <sub>i</sub> × C <sub>n</sub> ≥ 5000 s FOR C > 0.33 μF
■ DIELECTRIC LOSS tanδ AT F = 1 kHz AND 20 °C	≤ 10 × 10 <sup>-4</sup>
■ SOLDERING	IEC 60068-2-20, MAX. 2 s
■ RESISTANCE TO SOLDERING HEAT	IEC 60068-2-20, 260 °C ± 5 °C, 10 s ± 1 s
■ SELF INDUCTANCE	APPROX. 10 nH/cm OF CAPACITOR LENGTH AND TERMINALS
■ COMPLIES TO	IEC 60384-14, UL 60384-14 CSA 60384-14
■ APPLICATION	RFI SUPPRESSION CLASS X1 (ACROSS-THE-LINE CONNECTION) CAPACITOR IS AVAILABLE IN CD VERSION SUITABLE FOR SERIES CONNECTION TO THE SUPPLY MAINS (CAPACITIVE POWER SUPPLY)

# CAPACITORS

## TYPE KNB1540, KNB1542, KNB1543

CASING: THERMOPLASTIC (PP OR ON REQUEST PBT HF) SEALED WITH SYNTHETICAL RESIN	THERMOPLASTIC MATERIAL AND SYNTHETICAL RESIN ARE SELF-EXTINGUISHING ACCORDING TO UL 94. CLASS V-0.	
TERMINALS		
TYPE	TERMINAL LENGHT	TYPE OF TERMINALS
KNB1540	3 <sup>+0.5</sup> , 4 <sup>+0.5</sup> , 6 <sup>+1</sup> , 9 <sup>+1</sup> , 15 <sup>+2</sup> , 20 <sup>+2</sup> , 25 <sup>+5</sup> , 30 <sup>+5</sup> , 50 <sup>+5</sup> mm, OTHER ON REQUEST	TINNED COPPER WIRE
KNB1542	20 TO 200 mm	INSULATED STRANDED WIRE 0.5 mm <sup>2</sup>
KNB1543	20 TO 200 mm	INSULATED SOLID WIRE $\phi$ 0.8 mm , TERMINAL ENDS ON REQUEST

### STANDARD VALUES KNB1540, KNB1542, KNB1543, 440 V AC, CLASS X1

CAPACITANCE C (µF)	DIMENSIONS				 IEC 60384-14 440 V AC	FOR CAPACITORS WITH INSULATED LEADS ON REQUEST	
	L (mm)	H (mm)	W (mm)	PCM (mm)		 UL 60384-14 CSA 60384-14 440 V AC	 IEC 60384-14 440 V AC
0.0022	18	11	5.5	15	●	●	●
0.0033	18	11	5.5	15	●	●	●
0.0047	18	11	5.5	15	●	●	●
0.0068	18	11	5.5	15	●	●	●
0.01	18	12	6	15	●	●	●
0.015	18	13	7	15	●	●	●
0.022	18	14.5	8.5	15	●	●	●
0.033	18	18.5	9	15	●	●	●
0.047	18	20	12.5	15	●	●	●
0.015	27	15	6.5	22.5	●	●	●
0.022	27	15	6.5	22.5	●	●	●
0.033	27	15	6.5	22.5	●	●	●
0.047	27	16.5	7	22.5	●	●	●
0.068	27	18.5	8.5	22.5	●	●	●
0.1	27	20	10.5	22.5	●	●	●
0.15	27	23	14	22.5	●	●	●
0.22	27	25	16	22.5	●	●	●
0.1	32	19	10	27.5	●	●	●
0.15	32	20	11	27.5	●	●	●
0.22	32	23.5	14	27.5	●	●	●
0.27	32	24.5	15	27.5	●	●	●
0.33	32	28	18	27.5	●	●	●
0.47	32	33	20	27.5	●	●	●
0.68	32	39	24	27.5	●	●	●

● APPROVALS IN USE

**NOTE:**  
APPROVAL CQC ONLY FOR PBT HF CASE.

# CAPACITORS

## TYPE KNB1550, KNB1552, KNB1553

**CLASS X1**  
310 V AC  
+110 °C

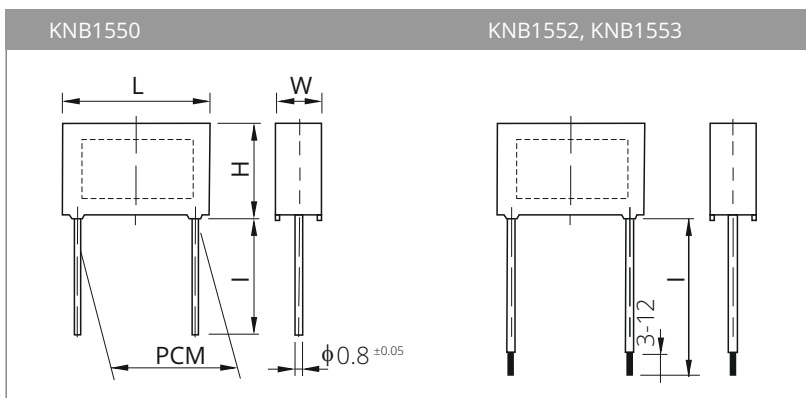
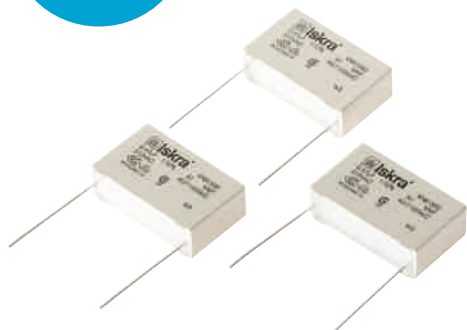

### ELECTRICAL CONNECTION

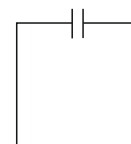

### TECHNICAL DATA



■ CONSTRUCTION	POLYPROPYLENE FILM, METALLIZED
■ RATED VOLTAGE	310 V AC
■ CAPACITANCE TOLERANCE	± 20 % FOR C ≤ 0.1 μF ± 10 % FOR C > 0.1 μF
■ CLIMATIC CATEGORY	40/110/56 ACC. TO IEC 60068-1
■ PASSIVE FLAMMABILITY	ACC. TO IEC 60384-14
■ TEMPERATURE RANGE	-40 ° to +110 °C
■ TEST VOLTAGE	3000 V DC, 1 s FOR C < 1 μF 2800 V DC, 1 s FOR C ≥ 1 μF
■ MAX. PULSE RISE TIME du/dt, AT 438 V DC	600 V / μs FOR PCM = 11 mm 500 V / μs FOR PCM = 15 mm 400 V / μs FOR PCM = 22.5 mm 200 V / μs FOR PCM = 27.5 mm PULSE TEST ACC. TO IEC 60384-14
■ INSULATION RESISTANCE AT 20 °C , U <sub>m</sub> = 100 V DC, t = 1 min	R <sub>i</sub> ≥ 15000 MΩ FOR C ≤ 0.33 μF R <sub>i</sub> × C <sub>n</sub> ≥ 5000 s FOR C > 0.33 μF
■ DIELECTRIC LOSS tanδ AT F = 1 kHz AND 20 °C	≤ 1 × 10 <sup>-3</sup>
■ SOLDERING	IEC 60068-2-20, MAX. 2 s
■ RESISTANCE TO SOLDERING HEAT	IEC 60068-2-20, 260 °C ± 5 °C, 10 s ± 1 s
■ SELF INDUCTANCE	APPROX. 10 nH/cm OF CAPACITOR LENGTH AND TERMINALS
■ COMPLIES TO	IEC 60384-14, UL 60384-14 CSA 60384-14
■ APPLICATION	RFI SUPPRESSION CLASS X1 (ACROSS-THE-LINE CONNECTION) CAPACITOR IS AVAILABLE IN CD VERSION SUITABLE FOR SERIES CONNECTION TO THE SUPPLY MAINS (CAPACITIVE POWER SUPPLY)

# CAPACITORS

## TYPE KNB1550, KNB1552, KNB1553

CASING: THERMOPLASTIC (PP OR ON REQUEST PBT HF) SEALED WITH SYNTHETICAL RESIN	THERMOPLASTIC MATERIAL AND SYNTHETICAL RESIN ARE SELF-EXTINGUISHING ACCORDING TO UL 94. CLASS V-0.	
TERMINALS		
TYPE	TERMINAL LENGHT	TYPE OF TERMINALS
KNB1550	4 <sup>±0.5</sup> , 6 <sup>-1</sup> , 25 <sup>±5</sup> , 30 <sup>±5</sup> mm, OTHER ON REQUEST	TINNED COPPER WIRE
KNB1552	20 TO 200 mm	INSULATED STRANDED WIRE 0.5 mm <sup>2</sup>
KNB1553	20 TO 200 mm	INSULATED SOLID WIRE $\phi$ 0.8 mm, TERMINAL ENDS ON REQUEST

### STANDARD VALUES KNB1550, KNB1552, KNB1553, 310 V AC, +110 °C, CLASS X1

CAPACITANCE C (µF)	DIMENSIONS					 IEC 60384-14 310 V AC	 UL 60384-14 CSA 60384-14 310 V AC	 IEC 60384-14 310 V AC
	L (mm)	H (mm)	W (mm)	PCM (mm)	Ø (mm)			
0.01	13	9.5	4.3	10	0.6	●	●	●
0.015	13	10.5	5	10	0.6	●	●	●
0.022	13	11.5	6	10	0.6	●	●	●
0.033	13	13.5	6	10	0.6	●	●	●
0.01	18	11	5	15	0.8	●	●	●
0.015	18	11	5	15	0.8	●	●	●
0.022	18	11	5	15	0.8	●	●	●
0.033	18	11	5	15	0.8	●	●	●
0.047	18	12	6	15	0.8	●	●	●
0.068	18	13	7	15	0.8	●	●	●
0.1	18	13.5	7.5	15	0.8	●	●	●
0.15	18	16	9.5	15	0.8	●	●	●
0.22	18	18.5	11	15	0.8	●	●	●
0.1	26.5	14	6	22.5	0.8	●	●	●
0.15	26.5	14	6	22.5	0.8	●	●	●
0.22	26.5	16.4	8.5	22.5	0.8	●	●	●
0.33	26.5	18.5	10	22.5	0.8	●	●	●
0.47	26.5	21.5	12.5	22.5	0.8	●	●	●
0.33	31.5	17	9	27.5	0.8	●	●	●
0.47	31.5	19	10	27.5	0.8	●	●	●
0.68	31.5	22	13	27.5	0.8	●	●	●
1	32	24.5	15	27.5	0.8	●	●	●
1.5	31.5	32	18	27.5	0.8	●	●	●
2.2	31.5	35.5	24	27.5	0.8	●	●	●

● APPROVALS IN USE

**NOTE:**  
APPROVAL CQC ONLY FOR PBT HF CASE.

# CAPACITORS

## TYPE KNB753x

CLASS X2Y2  
275 V AC

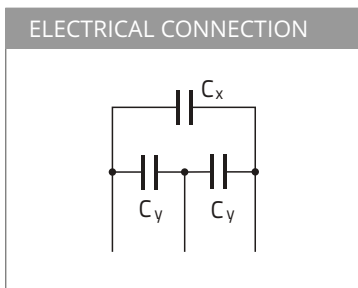
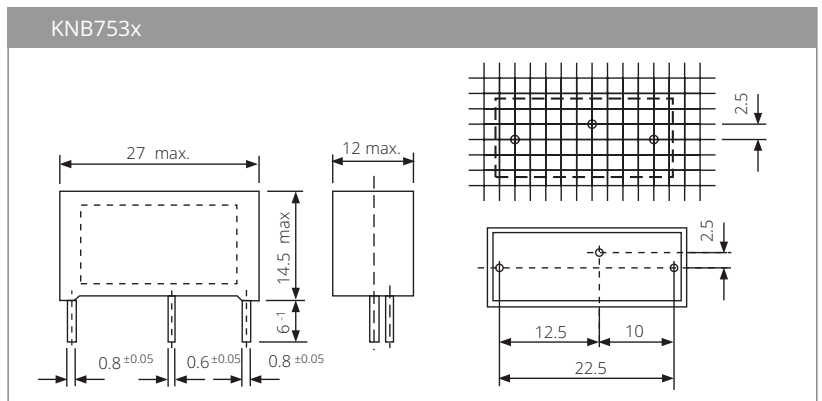

### TECHNICAL DATA

■ CONSTRUCTION	POLYPROPYLENE FILM, METALLIZED
■ RATED VOLTAGE	275 V AC
■ CAPACITANCE TOLERANCE	± 20 % (± 10 % ON REQUEST)
■ CLIMATIC CATEGORY	40/100/56 ACC. TO IEC 60068-1
■ PASSIVE FLAMMABILITY	ACC. TO IEC 60384-14
■ TEMPERATURE RANGE	-40 ° to +100 °C
■ MAX. PULSE RISE TIME du/dt, AT 438 V DC	100 V / μs AT 390 V DC ACC. TO IEC 60384-14
■ TEST VOLTAGE	X2 - CAPACITORS 1700 V DC, 2 s Y2 - CAPACITORS 2700 V DC, 2 s
■ INSULATION RESISTANCE AT 20 °C, U <sub>m</sub> = 100 V DC, t = 1 min	R <sub>i</sub> ≥ 15000 MΩ
■ DIELECTRIC LOSS tanδ AT F = 1 kHz AND 20 °C	≤ 20 x 10 <sup>-4</sup>
■ SOLDERING	IEC 60068-2-20, MAX. 2 s
■ RESISTANCE TO SOLDERING HEAT	IEC 60068-2-20, 260 °C ± 5 °C, 10 s ± 1 s
■ COMPLIES TO	IEC 60384-14

### STANDARD VALUES KNB753X 275 V AC, CLASS X2Y2

CAPACITANCE C <sub>x</sub> (μF)	CAPACITANCE C <sub>y</sub> (pF)	
0.1	2 x 1000	
0.1	2 x 1500	
0.1	2 x 2200	
0.1	2 x 3300	
0.1	2 x 4700	
0.15	2 x 1000	
0.15	2 x 1500	
0.15	2 x 2200	
0.15	2 x 2700	●
0.15	2 x 3300	
0.15	2 x 4700	●
0.22	2 x 1000	
0.22	2 x 1500	
0.22	2 x 2200	
0.22	2 x 3300	●
0.22	2 x 4700	
0.25	2 x 1000	
0.25	2 x 1500	
0.25	2 x 2200	
0.25	2 x 3300	
0.25	2 x 4700	

● APPROVALS IN USE

CASING: THERMOPLASTIC  
SEALED WITH SYNTHETICAL RESIN

THERMOPLASTIC MATERIAL IS SELF-EXTINGUISHING ACCORDING TO UL 94. CLASS V-0.

### TERMINALS

TYPE	TYPE OF TERMINALS
KNB753x	SOLID COPPER TINNED WIRE OR INSULATED STRANDED WIRE

# CAPACITORS

## TYPE KPB23xx

CLASS X1  
TWO-POLE

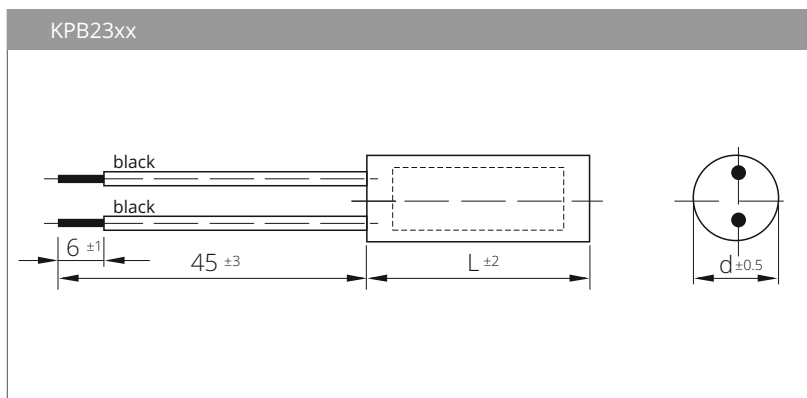

LAST TWO NUMBERS IN THE TYPE DESIGNATION (XX = 00 TO 49) INDICATE THE TYPE OF TERMINALS AND CONNECTORS.

### ELECTRICAL CONNECTION

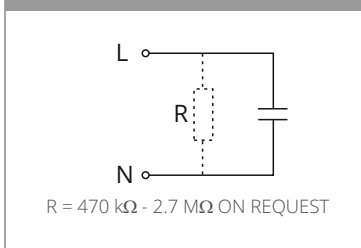

### TECHNICAL DATA

■ CONSTRUCTION	PAPER IMPREGNATED
■ ELECTRODES	ALUMINIUM FOIL
■ RATED VOLTAGE	275 V AC
■ CAPACITANCE TOLERANCE	± 20 %
■ CLIMATIC CATEGORY	25/100/21 ACC. TO IEC 60068-1
■ PASSIVE FLAMMABILITY	ACC. TO IEC 60384-14
■ TEMPERATURE RANGE	-25 ° to +100°C
■ TEST VOLTAGE	1790 V DC, 2 s
■ INSULATION RESISTANCE AT 20 °C , U <sub>m</sub> = 100 V DC, t = 1 min	R <sub>i</sub> ≥ 6000 MΩ FOR C ≤ 0.33 µF R <sub>i</sub> ≥ C <sub>n</sub> 2000 FOR C > 0.33 µF
■ COMPLIES TO	IEC/EN 60384-14

### Standard values KPB23xx

CAPACITANCE C, (µF)	DIMENSIONS d x l (mm)
0.01	8 x 30
0.022	9.5 x 30
0.027	9.5 x 30
0.033	9.5 x 30
0.047	11 x 30
0.068	12 x 30
0.1	14 x 35
0.15	16 x 35
0.22	18 x 35
0.22	18 x 40
0.27	20 x 35
0.27	20 x 40
0.33	20 x 40
0.47	25 x 40

APPROVALS:  
COMPLIES WITH EN 60384-14

CASING: THERMOPLASTIC  
SEALED WITH SYNTHETICAL RESIN,  
FLAME RETARDANT

WIRE DIMENSIONS ON DRAWING CORRESPOND WITH TYPE KPB2300 - STANDARD VERSION.

### TERMINALS

TYPE	TYPE OF TERMINALS
KPB23xx	INSULATED STRANDED WIRE 0.5 mm <sup>2</sup> , OR INSULATED SOLID WIRE ø 0.8 mm. NON-INSULATED PART IS SOLDERED. WIRES CAN BE EQUIPPED WITH CONNECTION TERMINALS ON REQUEST.

# CAPACITORS

## TYPE KPR23xx

**CLASS X1**  
RC UNITS  
TWO-POLE

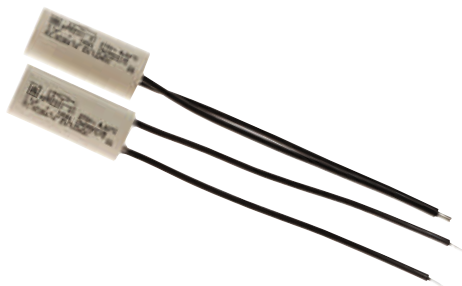

LAST TWO NUMBERS IN THE TYPE DESIGNATION (XX = 00 TO 49) INDICATE THE TYPE OF TERMINALS AND CONNECTORS.

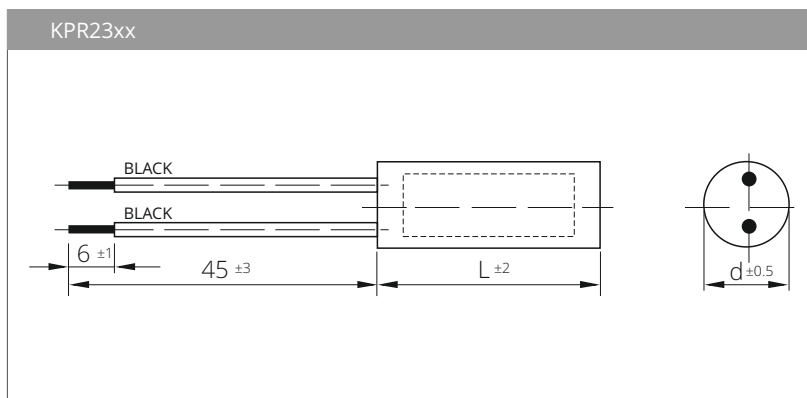

### ELECTRICAL CONNECTION

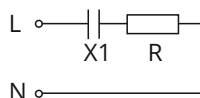

### TECHNICAL DATA

■ DIELECTRIC	PAPER IMPREGNATED
■ ELECTRODES	ALUMINIUM FOIL
■ RATED VOLTAGE	275 V AC
■ CAPACITANCE TOLERANCE	± 20 %
■ CLIMATIC CATEGORY	25/085/21 ACC. TO IEC 60068-1
■ PASSIVE FLAMMABILITY	ACC. TO IEC 60384-14
■ TEMPERATURE RANGE	-25 ° TO +85 °C
■ TEST VOLTAGE	1790 V DC, 2 s
■ COMPLIES TO	IEC/EN 60384-14
■ RATED TEMPERATURE	$v_{01}$ 50 °C

### Standard values KPR23xx

CAPACITANCE $C_1$ (μF)	RESISTOR R (MΩ)	DIMENSIONS d x l (mm)
0.01	50	12 x 30
0.1	50	16 x 35

APPROVALS:  
COMPLIES WITH EN 60384-14

CASING: THERMOPLASTIC  
SEALED WITH SYNTHETICAL RESIN,  
FLAME RETARDANT

WIRE DIMENSIONS ON DRAWING CORRESPOND WITH TYPE KPR2300 - STANDARD VERSION.

### TERMINALS

TYPE	TYPE OF TERMINALS
KPR23xx	INSULATED STRANDED WIRE 0.5 mm <sup>2</sup> , OR INSULATED SOLID WIRE ø 0.8 mm. NON-INSULATED PART IS SOLDERED. WIRES CAN BE EQUIPPED WITH CONNECTION TERMINALS ON REQUEST.



# CAPACITORS

## TYPE KPB53xx

CLASS Y2  
TWO-POLE

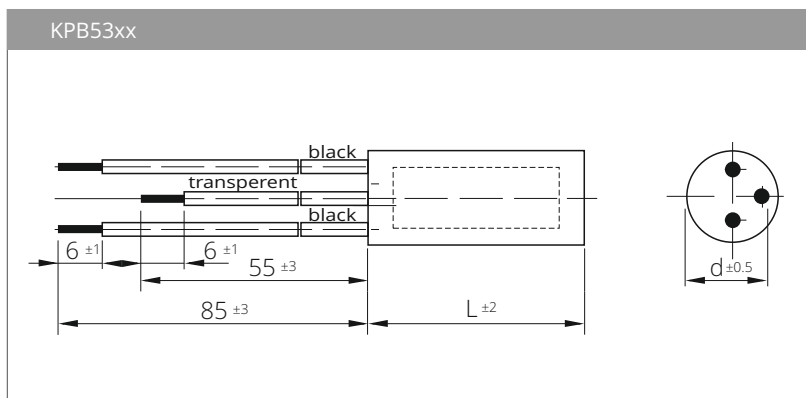

LAST TWO NUMBERS IN THE TYPE DESIGNATION (XX = 00 TO 49) INDICATE THE TYPE OF TERMINALS AND CONNECTORS.

### ELECTRICAL CONNECTION

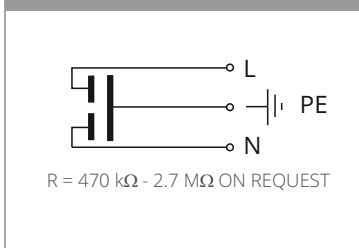

### TECHNICAL DATA

■ CONSTRUCTION	PAPER IMPREGNATED
■ ELECTRODES	ALUMINIUM FOIL
■ RATED VOLTAGE	275 V AC
■ CAPACITANCE TOLERANCE	± 20 %
■ CLIMATIC CATEGORY	25/100/21 ACC. TO IEC 60068-1
■ PASSIVE FLAMMABILITY	ACC. TO IEC 60384-14
■ TEMPERATURE RANGE	-25 ° TO +100°C
■ TEST VOLTAGE	2050 V AC, 2 s
■ INSULATION RESISTANCE AT 20 °C , U <sub>m</sub> = 100 V DC, t = 1 min	R <sub>i</sub> ≥ 6000 MΩ FOR C ≤ 0.33 μF
■ COMPLIES TO	IEC/EN 60384-14

### STANDARD VALUES KPB53XX

CAPACITANCE class Y2 (μF)	DIMENSIONS	
	D (mm)	L (mm)
2 x 0.0010	11	30
2 x 0.0022	11	30
2 x 0.0025	11	30
2 x 0.0027	11	30
2 x 0.0033	11	30
2 x 0.0047	11	30
2 x 0.0050	11	30
2 x 0.0068	12	30
2 x 0.010	12	30
2 x 0.015	12	30
2 x 0.010	12	35
2 x 0.015	12	35
2 x 0.022	14	35
2 x 0.027	14	35
2 x 0.033	16	35
2 x 0.047	18	35
2 x 0.068	20	35

APPROVAL:



CASING: THERMOPLASTIC  
SEALED WITH SYNTHETICAL RESIN,  
FLAME RETARDANT

WIRE DIMENSIONS ON DRAWING CORRESPOND WITH TYPE KPB5300 - STANDARD VERSION.

### TERMINALS

TYPE	TYPE OF TERMINALS
KPB53xx	INSULATED STRANDED WIRE 0.5 mm <sup>2</sup> , OR INSULATED SOLID WIRE Ø 0.8 MM. NON-INSULATED PART IS SOLDERED. WIRES CAN BE EQUIPPED WITH CONNECTION TERMINALS ON REQUEST.

# CAPACITORS

## TYPE KPB70xx

CLASS X1Y2  
TWO-POLE

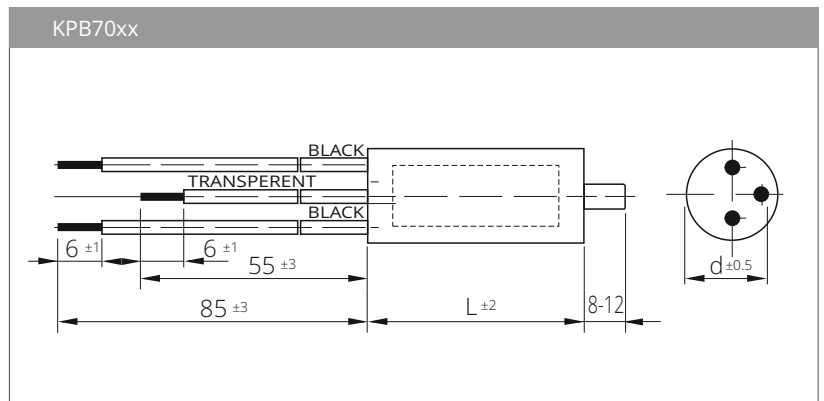
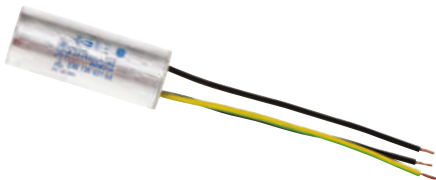

LAST TWO NUMBERS IN THE TYPE DESIGNATION (XX = 00 TO 49) INDICATE THE TYPE OF TERMINALS AND CONNECTORS.

### ELECTRICAL CONNECTION

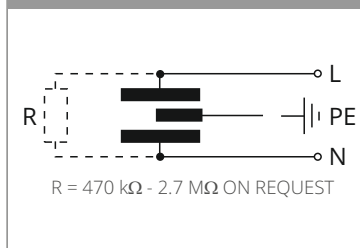

### TECHNICAL DATA

■ DIELECTRIC	PAPER IMPREGNATED
■ ELECTRODES	ALUMINIUM FOIL
■ RATED VOLTAGE	275 V AC, 50/60 Hz
■ CAPACITANCE TOLERANCE	± 20 %
■ CLIMATIC CATEGORY	25/100/21 ACC. TO IEC 60068-1
■ PASSIVE FLAMMABILITY	CATEGORY A
■ TEMPERATURE RANGE	-25 °TO +100°C
■ TEST VOLTAGE	X1 CAPACITOR 1790 V DC, 2 s Y2 CAPACITOR 2050 V AC, 2 s
■ INSULATION RESISTANCE AT 20 °C , U <sub>m</sub> = 100 V DC, t = 1 min	R <sub>i</sub> ≥ 6000 MΩ FOR C ≤ 0.33 μF R <sub>i</sub> x C <sub>n</sub> ≥ 2000 s FOR C > 0.33 μF
■ COMPLIES TO	IEC/EN 60384-14

### STANDARD VALUES KPB70XX

CAPACITANCE CLASS X1 (μF)	CAPACITANCE CLASS X2 (PF)	DIMENSIONS d x l (mm)
0.27	2 x 27000	20 x 50
0.33	2 x 2700	22 x 40
0.33	2 x 2700	25 x 40
0.33	2 x 4700	22 x 40
0.33	2 x 4700	25 x 40
0.33	2 x 10000	25 x 40
0.33	2 x 15000	25 x 40
0.33	2 x 22000	25 x 40
0.33	2 x 27000	25 x 40
0.47	2 x 2700	25 x 40
0.47	2 x 2700	30 x 40
0.47	2 x 4700	25 x 40
0.47	2 x 4700	30 x 40
0.47	2 x 10000	25 x 40
0.47	2 x 10000	30 x 40
0.47	2 x 15000	30 x 40
0.47	2 x 22000	30 x 40
0.47	2 x 27000	30 x 40

APPROVAL:



IEC 60384-14

CASING: ALUMINIUM CAN, CLOSED WITH SEALING WASHER, SEALED WITH SYNTHETICAL RESIN, FLAME RETARDANT.

WIRE DIMENSIONS ON DRAWING CORRESPOND WITH TYPE KPB7000 - STANDARD VERSION.

### TERMINALS

TYPE	TYPE OF TERMINALS
KPB70xx	INSULATED STRANDED WIRE 0.5 mm <sup>2</sup> , OR INSULATED SOLID WIRE ø 0.8 mm. NON-INSULATED PART IS SOLDERED.CONNECTION TERMINALS PROVIDED ON REQUEST.

# CAPACITORS

## TYPE KPB7077

CLASS X1Y2

FOUR-POLE

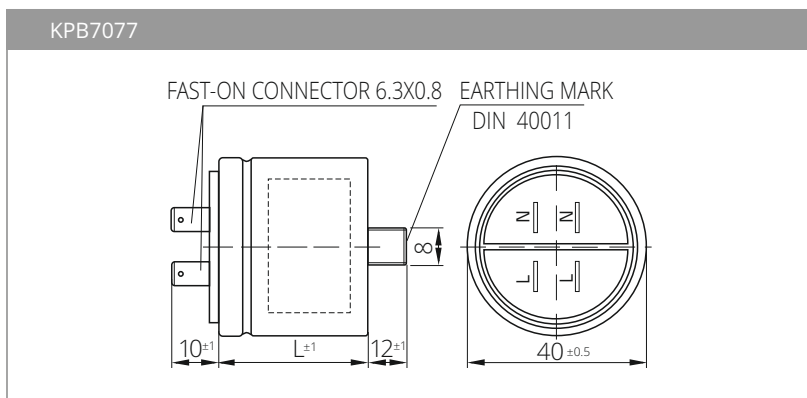

### ELECTRICAL CONNECTION

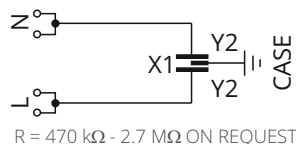

### TECHNICAL DATA

■ DIELECTRIC	PAPER IMPREGNATED
■ ELECTRODES	ALUMINIUM FOIL
■ RATED VOLTAGE	275 V AC
■ CAPACITANCE TOLERANCE	± 20 %
■ CLIMATIC CATEGORY	25/100/21 ACC. TO IEC 60068-1
■ PASSIVE FLAMMABILITY	CATEGORY A
■ TEMPERATURE RANGE	-25 ° TO +100 °C
■ TEST VOLTAGE	X1 CAPACITOR 1790 V DC, 2 s Y2 CAPACITOR 2050 V AC, 2 s
■ INSULATION RESISTANCE AT 20 °C , U <sub>m</sub> = 100 V DC, t = 1 min	R <sub>i</sub> ≥ 6000 MΩ FOR C ≤ 0.33 μF R <sub>i</sub> x C <sub>n</sub> ≥ 2000 s FOR C > 0.33 μF
■ RATED TEMPERATURE	υ <sub>u</sub> 85 °C
■ COMPLIES TO	IEC/UL/CSA 60384-14

### STANDARD VALUES KPB7077

CAPACITANCE CLASS X1 (μF)	CAPACITANCE CLASS X2 (pF)	DIMENSIONS d x l (mm)
0.1	2 x 5000	30
0.1	2 x 10000	30
0.1	2 x 15000	30
0.1	2 x 27000	30
0.25	2 x 5000	30
0.25	2 x 10000	30
0.25	2 x 15000	30
0.25	2 x 27000	30
0.3	2 x 5000	30
0.3	2 x 10000	30
0.3	2 x 15000	33
0.3	2 x 27000	33
0.47	2 x 5000	33
0.47	2 x 10000	33
0.47	2 x 15000	33
0.47	2 x 27000	33
0.5	2 x 10000	33

APPROVALS:

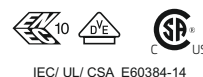

### TERMINALS

2 x DOUBLE FAST-ON CONNECTORS CuZn/Sn

# CAPACITORS

## TYPE KPB73xx

CLASS X1Y2  
TWO-POLE

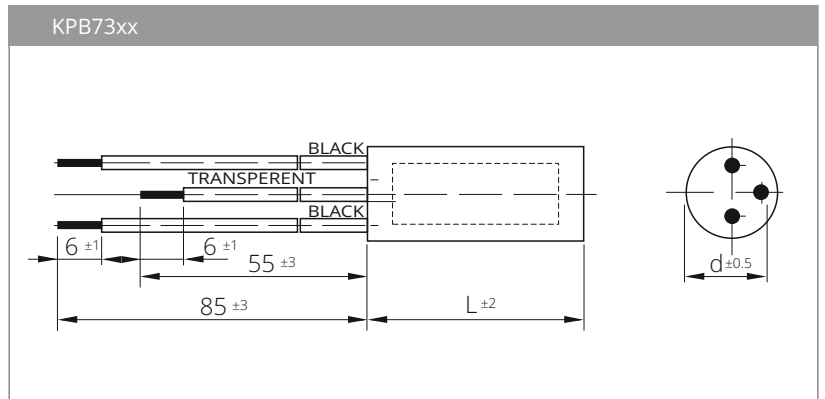
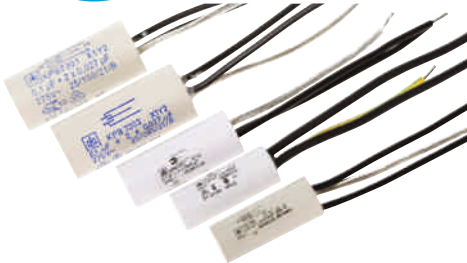

LAST TWO NUMBERS IN THE TYPE DESIGNATION (XX = 00 TO 49) INDICATE THE TYPE OF TERMINALS AND CONNECTORS.

### ELECTRICAL CONNECTION

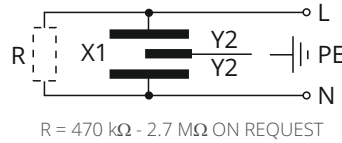

### TECHNICAL DATA

■ DIELECTRIC	PAPER IMPREGNATED
■ ELECTRODES	ALUMINIUM FOIL
■ RATED VOLTAGE	250 V AC, 275 V AC
■ CAPACITANCE TOLERANCE	± 20 %
■ CLIMATIC CATEGORY	25/100/21 ACC. TO IEC 60068-1
■ PASSIVE FLAMMABILITY	ACC. TO IEC 60384-14
■ TEMPERATURE RANGE	-25 ° TO +100 °C
■ TEST VOLTAGE	X1 CAPACITOR 1790 V DC, 2 s Y2 CAPACITOR 2050 V AC, 2 s
■ INSULATION RESISTANCE AT 20 °C , U <sub>m</sub> = 100 V DC, t = 1 min	R <sub>i</sub> ≥ 6000 MΩ FOR C ≤ 0.33 μF R <sub>i</sub> x C <sub>n</sub> ≥ 2000 s FOR C > 0.33 μF
■ COMPLIES TO	IEC/UL/CSA 60384-14

# CAPACITORS

## TYPE KPB73xx

CASING: THERMOPLASTIC, SEALED WITH SYNTHETICAL RESIN, FLAME RETARDANT.

WIRE DIMENSIONS ON DRAWING CORRESPOND WITH TYPE KPB7300 - STANDARD VERSION.

### TERMINALS

TYPE

TYPE OF TERMINALS

KPB73xx

INSULATED STRANDED WIRE 0.5 mm<sup>2</sup>, OR INSULATED SOLID WIRE  $\varnothing$  0.8 mm.  
NON-INSULATED PART IS SOLDERED. CONNECTION TERMINALS PROVIDED ON REQUEST.

### STANDARD VALUES KPB73XX

CAPACITANCE CLASS X1 ( $\mu$ F)	CAPACITANCE CLASS Y2 (pF)	DIMENSIONS d x l (mm)
0.022	2 x 2700	11 x 30
0.022	2 x 4700	12 x 30
0.022	2 x 5000	14 x 35
0.022	2 x 22000	16 x 35
0.022	2 x 22000	18 x 35
0.027	2 x 2700	11 x 30
0.047	2 x 2700	12 x 30
0.047	2 x 4700	14 x 30
0.047	2 x 5000	14 x 30
0.068	2 x 2700	14 x 35
0.068	2 x 4700	14 x 35
0.068	2 x 5000	14 x 35
0.1	2 x 2500	14 x 35
0.1	2 x 2700	14 x 35
0.1	2 x 4700	14 x 35
0.1	2 x 4700	16 x 35
0.1	2 x 5000	14 x 35
0.1	2 x 5000	16 x 35
0.1	2 x 10000	16 x 35
0.1	2 x 15000	16 x 35
0.1	2 x 22000	18 x 35
0.1	2 x 27000	18 x 40
0.1	2 x 27000	20 x 35
0.15	2 x 2700	16 x 35
0.15	2 x 4700	16 x 35
0.15	2 x 5000	16 x 35
0.15	2 x 5000	18 x 35
0.15	2 x 5000	18 x 40
0.15	2 x 10000	18 x 35
0.15	2 x 15000	18 x 35
0.15	2 x 22000	20 x 35
0.15	2 x 27000	18 x 40
0.15	2 x 27000	20 x 35
0.22	2 x 2700	18 x 40
0.22	2 x 2700	20 x 35
0.22	2 x 4700	18 x 40
0.22	2 x 5000	18 x 40
0.22	2 x 10000	20 x 40
0.22	2 x 15000	20 x 40
0.22	2 x 22000	22 x 40
0.22	2 x 27000	22 x 40

CAPACITANCE CLASS X1 ( $\mu$ F)	CAPACITANCE CLASS Y2 (pF)	DIMENSIONS d x l (mm)
0.25	2 x 2500	20 x 40
0.25	2 x 2700	20 x 40
0.25	2 x 4700	20 x 40
0.25	2 x 5000	20 x 40
0.25	2 x 10000	20 x 40
0.25	2 x 15000	22 x 40
0.25	2 x 22000	22 x 40
0.25	2 x 27000	22 x 40
0.27	2 x 2700	20 x 40
0.27	2 x 4700	20 x 40
0.27	2 x 5000	20 x 40
0.27	2 x 10000	22 x 40
0.27	2 x 15000	22 x 40
0.27	2 x 22000	22 x 40
0.27	2 x 27000	20 x 50
0.27	2 x 27000	22 x 40
0.33	2 x 2700	22 x 40
0.33	2 x 2700	25 x 40
0.33	2 x 4700	22 x 40
0.33	2 x 4700	25 x 40
0.33	2 x 10000	25 x 40
0.33	2 x 15000	25 x 40
0.33	2 x 22000	25 x 40
0.33	2 x 27000	25 x 40
0.47	2 x 2700	25 x 40
0.47	2 x 2700	30 x 40
0.47	2 x 4700	25 x 40
0.47	2 x 4700	30 x 40
0.47	2 x 10000	25 x 40
0.47	2 x 10000	30 x 40
0.47	2 x 15000	30 x 40
0.47	2 x 22000	30 x 40
0.47	2 x 27000	30 x 40

APPROVAL:



# CAPACITORS

## TYPE KPB7325

CLASS X1Y2  
TWO-POLE



KPB7325

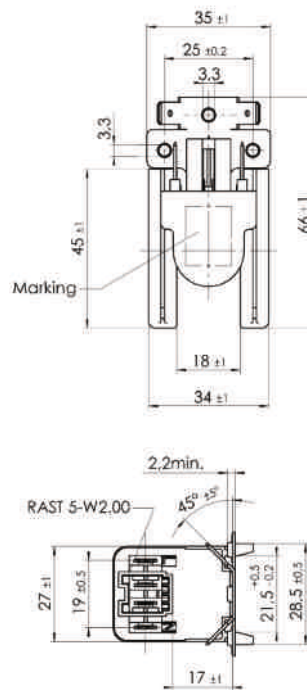

ELECTRICAL CONNECTION

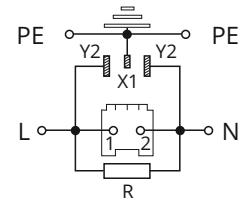

R = 470 kΩ - 2.7 MΩ ON REQUEST

### STANDARD VALUES

#### KPB7325

##### CAPACITANCE

CLASS X1 (μF)	CLASS Y2 (pF)
0.1	2 x 2500
0.1	2 x 2700
0.1	2 x 4700
0.1	2 x 5000
0.1	2 x 10000
0.1	2 x 15000
0.1	2 x 22000
0.1	2 x 27000
0.15	2 x 2500
0.15	2 x 2700
0.15	2 x 4700
0.15	2 x 5000
0.15	2 x 10000
0.15	2 x 15000
0.15	2 x 22000
0.15	2 x 27000
0.22	2 x 2500
0.22	2 x 2700
0.22	2 x 4700
0.22	2 x 5000
0.22	2 x 10000
0.22	2 x 15000
0.22	2 x 22000
0.22	2 x 27000
0.24	2 x 15000
0.24	2 x 27000
0.25	2 x 2500
0.25	2 x 2700
0.25	2 x 4700
0.25	2 x 5000
0.25	2 x 10000
0.25	2 x 15000
0.25	2 x 22000
0.25	2 x 27000
0.27	2 x 2500
0.27	2 x 2700
0.27	2 x 4700
0.27	2 x 5000
0.27	2 x 10000
0.27	2 x 15000
0.27	2 x 22000
0.27	2 x 27000

### TECHNICAL DATA

■ DIELECTRIC	PAPER IMPREGNATED
■ ELECTRODES	ALUMINIUM FOIL
■ RATED VOLTAGE	275 V AC
■ CAPACITANCE TOLERANCE	± 20 %
■ CLIMATIC CATEGORY	25/100/21/B
■ TEMPERATURE RANGE	-25 ° TO +100 °C
■ TEST VOLTAGE	X1 CAPACITOR 1790 V DC, 2 s Y2 CAPACITOR 2050 V AC, 2 s
■ INSULATION RESISTANCE AT 20 °C , U <sub>m</sub> = 100 V DC, t = 1 min	R <sub>i</sub> ≥ 6000 MΩ
■ CASING	THERMOPLASTIC CAN, SEALED WITH SYNTHETICAL RESIN, FLAME RETARDANT
■ TERMINALS	FAST-ON CONNECTORS 6.3x0.8 CuZn/Sn
■ COMPLIES TO	IEC/UL/CSA 60384-14
■ RATED TEMPERATURE	v <sub>o</sub> 85 °C

APPROVAL:



# CAPACITORS

## TYPE KPB7341

CLASS X1Y2  
TWO-POLE



### ELECTRICAL CONNECTION

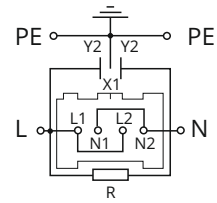

R = 470 kΩ - 2.7 MΩ ON REQUEST

KPB7341

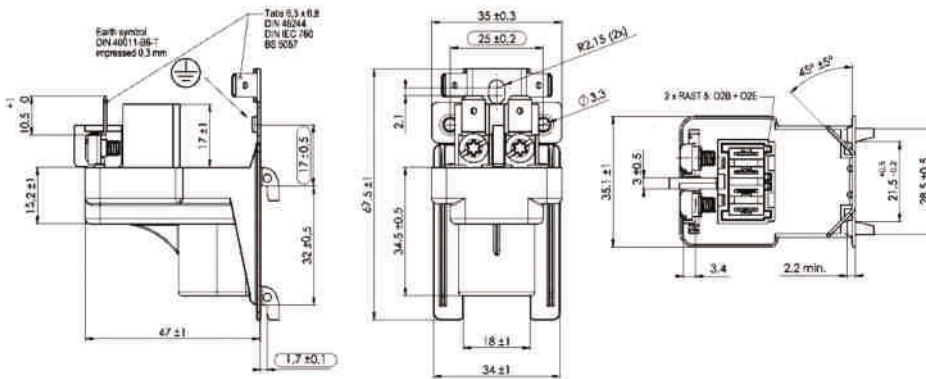

### TECHNICAL DATA

■ DIELECTRIC	PAPER IMPREGNATED
■ ELECTRODES	ALUMINIUM FOIL
■ RATED VOLTAGE	275 V AC
■ RATED CURRENT	16 A
■ CAPACITANCE TOLERANCE	± 20 %
■ CLIMATIC CATEGORY + LETTER INDICATING PASSIVE FLAMMABILITY CATEGORY	25/100/21/B
■ TEMPERATURE RANGE	-25 ° TO +100°C
■ TEST VOLTAGE	X1 CAPACITOR 1790 V DC, 2 s Y2 CAPACITOR 2050 V AC, 2 s
■ INSULATION RESISTANCE AT 20 °C , U <sub>m</sub> = 100 V DC, t = 1 min	R <sub>i</sub> ≥ 6000 MΩ
■ CASING	THERMOPLASTIC CAN, SEALED WITH SYNTHETICAL RESIN, FLAME RETARDANT
■ TERMINALS	FAST-ON CONNECTORS 6.3x0.8 CuZn/Sn
■ COMPLIES TO	IEC/UL/CSA 60384-14
■ RATED TEMPERATURE	u <sub>i</sub> 85 °C

### STANDARD VALUES KPB7341

CAPACITANCE	
CLASS X1 (μF)	CLASS Y2 (pF)
0.1	2 x 0.0027
0.1	2 x 0.0047
0.1	2 x 0.0050
0.1	2 x 0.0750
0.1	2 x 0.010
0.1	2 x 0.015
0.1	2 x 0.022
0.1	2 x 0.027

APPROVAL:



# CAPACITORS

## TYPE KPB7426

CLASS X1Y2  
TWO-POLE

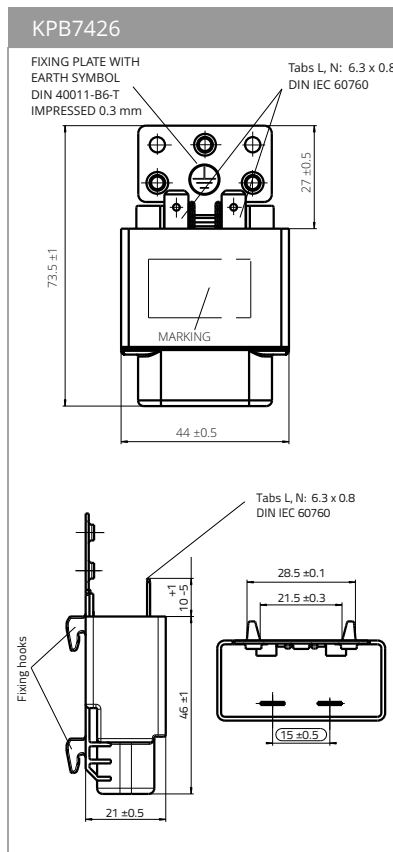

### ELECTRICAL CONNECTION

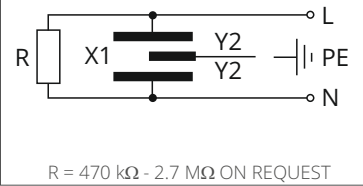

### TECHNICAL DATA

■ DIELECTRIC	PAPER IMPREGNATED
■ ELECTRODES	ALUMINIUM FOIL
■ RATED VOLTAGE	275 V AC
■ CAPACITANCE TOLERANCE	± 20 %
■ CLIMATIC CATEGORY	25/100/21/C
■ TEMPERATURE RANGE	-25 °TO +100°C
■ TEST VOLTAGE	X1 CAPACITOR 1790 V DC, 2 s Y2 CAPACITOR 2050 V AC, 2 s
■ INSULATION RESISTANCE AT 20 °C , U <sub>m</sub> = 100 V DC, t = 1 min	R <sub>i</sub> ≥ 6000 MΩ FOR C ≤ 0.33 μF
■ CASING	THERMOPLASTIC CAN, SEALED WITH SYNTHETICAL RESIN, FLAME RETARDANT
■ TERMINALS	3x FAST-ON CONNECTORS 6.3x0.8 CuZn/Sn
■ COMPLIES TO	IEC/EN 60384-14

### STANDARD VALUES KPB7426

CAPACITANCE	
CLASS X1 (μF)	CLASS Y2 (pF)
0.20	2 x 15000
0.47	2 x 15000

OTHER VALUES UPON REQUEST

APPROVAL:



IEC 60384-14



# CAPACITORS

## TYPE KPB7425

CLASS X1Y2

FOUR-POLE

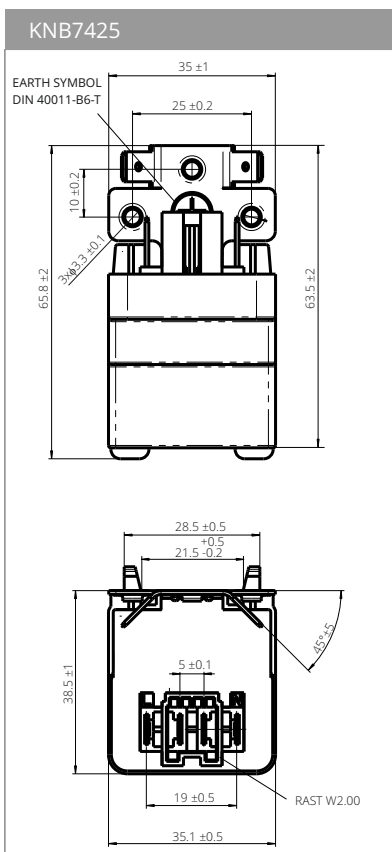

### ELECTRICAL CONNECTION

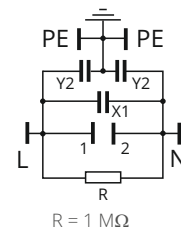

### TECHNICAL DATA

■ DIELECTRIC	POLYPROPYLENE FILM, METALLIZED
■ RATED VOLTAGE	275 V AC
■ RATED CURRENT	16 A
■ RATED TEMPERATURE	$v_u$ 85 °C
■ CAPACITANCE TOLERANCE	± 20 %
■ CLIMATIC CATEGORY - LETTER INDICATING PASSIVE CATEGORY	25/100/21/C
■ TEMPERATURE RANGE	-25 °C TO +100 °C
■ TEST VOLTAGE	X1 CAPACITOR 1790 V DC, 2 s Y2 CAPACITOR 2050 V AC, 2 s
■ INSULATION RESISTANCE AT 20 °C, $U_m = 100$ V DC, $t = 1$ min	$R_i \geq 6000$ MΩ
■ CASING	THERMOPLASTIC CAN, SEALED WITH SYNTHETICAL RESIN, FLAME RETARDANT
■ TERMINALS	FAST-ON CONNECTORS 6.3x0.8 CuZn/Sn
■ COMPLIES TO	IEC/EN 60384-14

### STANDARD VALUES KPB7425

CAPACITANCE	
CLASS X1 (μF)	CLASS Y2 (pF)
0.10	
0.15	
0.24	2 x 2200
0.25	to
0.27	2 x 27000
0.33	
0.47	

APPROVAL:



IEC 60384-14

# CAPACITORS

## TYPE KPB83xx

CLASS X1Y2  
FOUR-POLE



LAST TWO NUMBERS IN THE TYPE DESIGNATION (XX = 00 TO 49) INDICATE THE TYPE OF TERMINALS AND CONNECTORS.

### ELECTRICAL CONNECTION

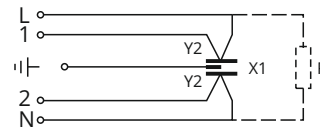

R = 470 kΩ - 2.7 MΩ ON REQUEST

### STANDARD VALUES KPB83XX

CAPACITANCE		DIMENSIONS
CLASS X1 (μF)	CLASS Y2 (pF)	d x L (mm)
0.022	2 x 2700	11 x 30
0.027	2 x 2700	11 x 30
0.047	2 x 2700	12 x 30
0.047	2 x 4700	14 x 30
0.047	2 x 5000	14 x 30
0.068	2 x 2700	14 x 35
0.068	2 x 4700	14 x 35
0.068	2 x 5000	14 x 35
0.1	2 x 2700	14 x 35
0.1	2 x 4700	14 x 35
0.1	2 x 4700	16 x 35
0.1	2 x 5000	14 x 35
0.1	2 x 10000	16 x 35
0.1	2 x 15000	16 x 35
0.1	2 x 22000	18 x 35
0.1	2 x 27000	18 x 35
0.15	2 x 2700	16 x 35
0.15	2 x 4700	16 x 35
0.15	2 x 5000	16 x 35
0.15	2 x 5000	18 x 35
0.15	2 x 5000	18 x 40
0.15	2 x 10000	18 x 35
0.15	2 x 15000	18 x 35
0.15	2 x 22000	20 x 35
0.15	2 x 27000	20 x 35
0.15	2 x 27000	22 x 40
0.22	2 x 2700	18 x 40
0.22	2 x 2700	20 x 35
0.22	2 x 4700	18 x 40
0.22	2 x 5000	18 x 40
0.22	2 x 10000	20 x 40
0.22	2 x 15000	20 x 40
0.22	2 x 22000	22 x 40
0.22	2 x 27000	22 x 40
0.27	2 x 2700	20 x 40
0.27	2 x 4700	20 x 35
0.27	2 x 5000	20 x 40
0.27	2 x 10000	22 x 40
0.27	2 x 15000	22 x 40
0.27	2 x 22000	22 x 40
0.27	2 x 27000	20 x 50
0.27	2 x 27000	22 x 40

OTHER VALUES  
UPON REQUEST

APPROVALS:  
COMPLIES WITH EN 60384-14

KPB83xx

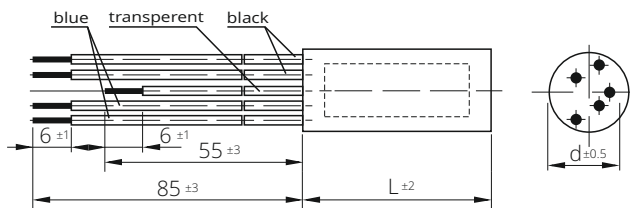

### TECHNICAL DATA

■ DIELECTRIC	PAPER IMPREGNATED
■ ELECTRODES	ALUMINIUM FOIL
■ RATED CURRENT	6 A
■ RATED VOLTAGE	275 V AC
■ CAPACITANCE TOLERANCE	± 20 %
■ CLIMATIC CATEGORY	25/085/21 ACC. TO IEC 60068-1
■ PASSIVE FLAMMABILITY	ACC. TO IEC 60384-14
■ TEMPERATURE RANGE	-25 °C TO +85 °C
■ TEST VOLTAGE	X1 CAPACITOR 1790 V DC, 2 s Y2 CAPACITOR 1800 V AC, 2 s
■ INSULATION RESISTANCE AT 20 °C , U <sub>m</sub> = 100 V DC, t = 1 min	R <sub>i</sub> ≥ 6000 MΩ FOR C ≤ 0.33 μF R <sub>i</sub> x C <sub>n</sub> ≥ 2000 s FOR C > 0.33 μF
■ COMPLIES TO	IEC/EN 60384-14

CASING: THERMOPLASTIC  
SEALED WITH SYNTHETICAL RESIN,  
FLAME RETARDANT

WIRE DIMENSIONS ON DRAWING CORRESPOND  
WITH TYPE KPB8300 -STANDARD VERSION.

#### TERMINALS

TYPE	TYPE OF TERMINALS
KPB83xx	INSULATED STRANDED WIRE 0.5 mm <sup>2</sup> , OR INSULATED SOLID WIRE ø 0.8 mm. NON-INSULATED PART IS SOLDERED. WIRES CAN BE EQUIPPED WITH CONNECTION TERMINALS ON REQUEST.

# FILTERS FOR RADIO INTERFERENCE SUPPRESSION TYPE KPL3008

CLASS X1Y2



## ELECTRICAL CONNECTION

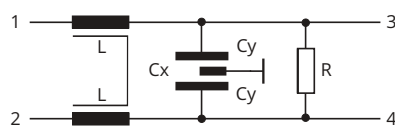

R = 470 k $\Omega$  - 2.7 M $\Omega$  ON REQUEST

KPL3008

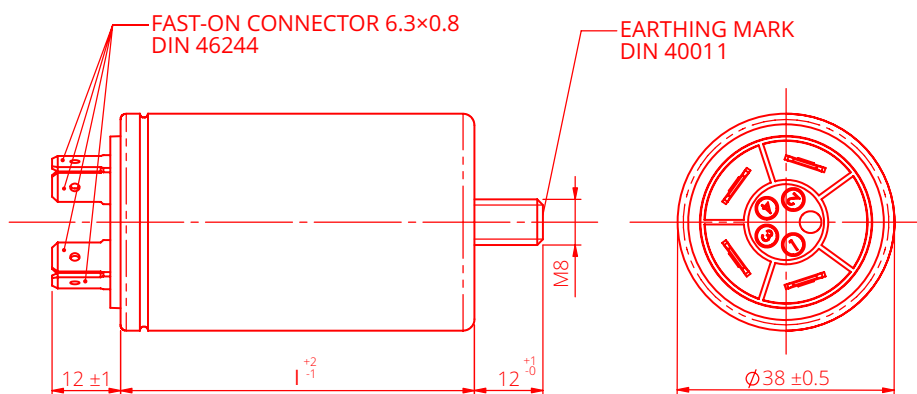

## TECHNICAL DATA

■ DIELECTRIC	PAPER IMPREGNATED
■ ELECTRODES	ALUMINIUM FOIL
■ RATED VOLTAGE	275 V AC
■ CAPACITANCE TOLERANCE	± 20 %
■ INDUCTANCE TOLERANCE	-30 % to +50 %
■ TEST VOLTAGE	X1 CAPACITOR 1790 V DC, 2 s Y2 CAPACITOR 2050 V AC, 2 s (OR 3000 V DC, 2 s)
■ INSULATION RESISTANCE AT 20 °C , U <sub>m</sub> = 100 V DC, t = 1 min	R <sub>i</sub> ≥ 6000 M $\Omega$ FOR C ≤ 0.33 $\mu$ F R <sub>i</sub> x C <sub>n</sub> ≥ 2000 s FOR C > 0.33 $\mu$ F
■ COMPLIES TO	IEC/EN 60939-2, UI1283, CSA C22.2 No. 8 CAPACITOR PART TO IEC 60384-14

CASING: ALUMINIUM CAN,  
CLOSED WITH SEALING WASHER.



### TERMINALS

TYPE	TYPE OF TERMINALS
KPL3008	4 FAST-ON CONNECTORST.

# FILTERS FOR RADIO INTERFERENCE SUPPRESSION

## TYPE KPL3008

### STANDARD VALUES KPL 3008 FOR UPPER TEMPERATURE 100 °C

CURRENT I (A)/T(°C)	NOMINAL VALUES								
	X1 (µF)	Y2 (pF)	INDUCTANCE L (mH)	DISCHARGING RESISTOR R (mΩ)	DIMENSIONS L (mm)				
7/40	0.15	2 x 2200 to 2 x 15000	0.5	1.5	38	●	●		
7/40			1	1.5	44	●	●		
10/40			0.5	1.5	38	●	●		
10/40			1	1.5	44	●	●		
16/40	0.25	2 x 2200 to 2 x 27000	0.3	1	58	●	●		
16/40			0.5	1	58	●	●		
16/40			1	1	62	●	●		
16/40			1.5	1	72	●	●		
10/70			0.3	1	58	●	●		
10/70			0.5	1	58	●	●		
10/70			1	1	62	●	●		
10/70			1.5	1	72	●	●		
10/40			0.47	2 x 2200 to 2 x 27000	0.5	0.68	62	●	●
10/40					1	0.68	62	●	●
12.5/40	0.3	0.68			62	●	●		
12.5/40	0.5	0.68			62	●	●		
12.5/40	1	0.68			62	●	●		
12.5/40	1.3	0.68			62	●	●		
12.5/40	1.5	0.68			67	●	●		
12.5/40	2	0.68			67	●	●		
16/40	0.3	0.68			62	●	●		
16/40	0.5	0.68			62	●	●		
16/40	1	0.68			67	●	●		
16/40	1.3	0.68			67	●	●		
16/40	1.5	0.68			72	●	●		
10/70	0.3	0.68			62	●	●		
10/70	0.5	0.68			62	●	●		
10/70	1	0.68			67	●	●		
10/70	1.3	0.68			67	●	●		
10/70	1.5	0.68			72	●	●		
3/40	0.15	2 x 6800			10	0.68	58	●	●
12.5/40	0.47	2 x 25000			1.3	0.68	58	●	●
3/40	1	2 x 10000	1	0.47	80	●	●		
10/40	1	2 x 2200 to 2 x 27000	0.5	0.47	80	●	●		
10/40			1	0.47	80	●	●		
12.5/40			0.3	0.47	80	●	●		
12.5/40			0.5	0.47	80	●	●		
12.5/40			1	0.47	80	●	●		
12.5/40			1.3	0.47	80	●	●		
12.5/40			1.5	0.47	85	●	●		
16/40			0.3	0.47	80	●	●		
16/40			0.5	0.47	80	●	●		
16/40			1	0.47	85	●	●		
16/40			1.3	0.47	85	●	●		
16/40			1.5	0.47	90	●	●		
10/70			0.3	0.47	80	●	●		
10/70			0.5	0.47	80	●	●		
10/70			1	0.47	85	●	●		
10/70			1.3	0.47	85	●	●		
10/70			1.5	0.47	90	●	●		

#### NOMINAL VALUES FOR CAPACITANCE:

\* 0.15 µF + 2 x 2200 pF  
 0.15 µF + 2 x 2200 pF  
 \* 0.15 µF + 2 x 4700 pF  
 0.15 µF + 2 x 5000 pF  
 0.15 µF + 2 x 10000 pF  
 0.15 µF + 2 x 15000 pF

\* 0.25 µF + 2 x 2200 pF  
 0.25 µF + 2 x 2700 pF  
 \* 0.25 µF + 2 x 4700 pF  
 0.25 µF + 2 x 5000 pF  
 \* 0.25 µF + 2 x 10000 pF  
 \* 0.25 µF + 2 x 15000 pF  
 0.25 µF + 2 x 18000 pF  
 \* 0.25 µF + 2 x 20000 pF  
 \* 0.25 µF + 2 x 22000 pF  
 0.25 µF + 2 x 25000 pF  
 0.25 µF + 2 x 27000 pF

\* 0.47 µF + 2 x 2200 pF  
 \* 0.47 µF + 2 x 2700 pF  
 0.47 µF + 2 x 4700 pF  
 0.47 µF + 2 x 5000 pF  
 0.47 µF + 2 x 10000 pF  
 \* 0.47 µF + 2 x 15000 pF  
 0.47 µF + 2 x 18000 pF  
 \* 0.47 µF + 2 x 20000 pF  
 0.47 µF + 2 x 22000 pF  
 0.47 µF + 2 x 25000 pF  
 0.47 µF + 2 x 27000 pF

1 µF + 2 x 2200 pF  
 1 µF + 2 x 2700 pF  
 1 µF + 2 x 4700 pF  
 1 µF + 2 x 5000 pF  
 1 µF + 2 x 10000 pF  
 1 µF + 2 x 15000 pF  
 1 µF + 2 x 18000 pF  
 1 µF + 2 x 20000 pF  
 1 µF + 2 x 22000 pF  
 1 µF + 2 x 25000 pF  
 1 µF + 2 x 27000 pF

\*

ONLY FOR IEC 60939-2

APPROVALS FOR CLIMATIC CATEGORY 40/100/56 ACCORDING TO IRC 60068-1

● APPROVALS IN USE

# FILTERS FOR RADIO INTERFERENCE SUPPRESSION TYPE KPL3009

CLASS X1Y2



## ELECTRICAL CONNECTION

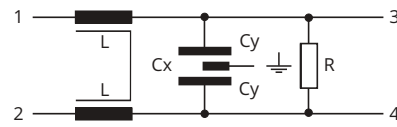

R = 470 kΩ - 2.7 MΩ ON REQUEST

KPL3009

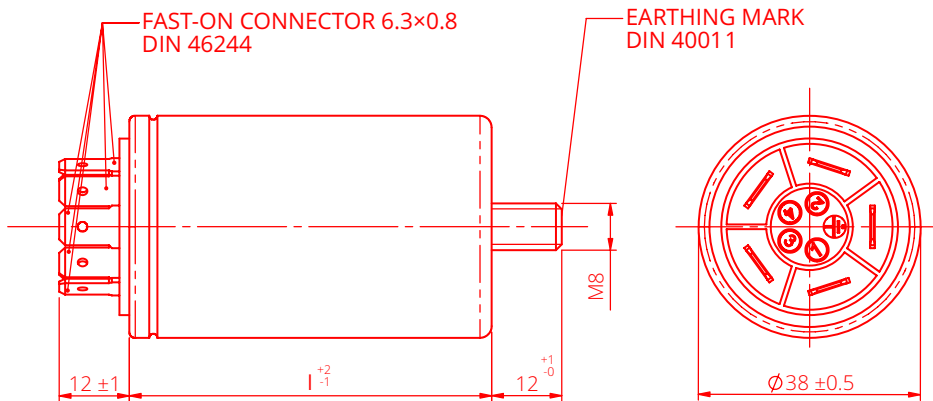

## TECHNICAL DATA

- |  |   |
|--|---|
| ■ DIELECTRIC   | PAPER IMPREGNATED   |
| ■ ELECTRODES   | ALUMINIUM FOIL  |
| ■ RATED VOLTAGE  | 275 V AC  |
| ■ CAPACITANCE TOLERANCE  | ± 20 %  |
| ■ INDUCTANCE TOLERANCE   | -30 % TO +50 %  |
| ■ TEST VOLTAGE   | X1 CAPACITOR 1790 V DC, 2 s<br>Y2 CAPACITOR 2050 V AC, 2 s<br>(OR 3000 V DC, 2 s) SHIELDS AGAINST CASING 2500 V AC, 2 s<br>(ONLY FILTERS WHERE Y2 - CAPACITOR IS NOT CONNECTED TO CASING) |
| ■ INSULATION RESISTANCE AT 20 °C ,<br>U <sub>m</sub> = 100 V DC, t = 1 min | R <sub>i</sub> ≥ 6000 MΩ FOR C ≤ 0.33 μF<br>R <sub>i</sub> x C <sub>n</sub> ≥ 2000 s FOR C > 0.33 μF  |
| ■ COMPLIES TO  | IEC/EN 60939-2, UI1283, CSA C22.2 No. 8<br>CAPACITOR PART TO IEC 60384-14   |

CASING: ALUMINIUM CAN,  
CLOSED WITH SEALING WASHER.



### TERMINALS

TYPE	TYPE OF TERMINALS
KPL3009	5 FAST-ON CONNECTORST.

# FILTERS FOR RADIO INTERFERENCE SUPPRESSION

## TYPE KPL3009

### STANDARD VALUES KPL 3009 FOR UPPER TEMPERATURE 100 °C

CURRENT I (A)/T(°C)	NOMINAL VALUES								
	X1 (µF)	Y2 (pF)	INDUCTANCE L (mH)	DISCHARGING RESISTOR R (mΩ)	DIMENSIONS L (mm)				
7/40	0.15	2 x 2200 to 2 x 15000	0.5	1.5	38	●	●		
7/40			1	1.5	44	●	●		
10/40			0.5	1.5	44	●	●		
10/40			1	1.5	44	●	●		
16/40	0.25	2 x 2200 to 2 x 27000	0.3	1	58	●	●		
16/40			0.5	1	58	●	●		
16/40			1	1	62	●	●		
16/40			1.5	1	72	●	●		
10/70			0.3	1	58	●	●		
10/70			0.5	1	58	●	●		
10/70			1	1	62	●	●		
10/70			1.5	1	72	●	●		
10/40			0.47	2 x 2200 to 2 x 27000	0.5	0.68	62	●	●
10/40					1	0.68	62	●	●
12.5/40	0.3	0.68			62	●	●		
12.5/40	0.5	0.68			62	●	●		
12.5/40	1	0.68			62	●	●		
12.5/40	1.3	0.68			62	●	●		
12.5/40	1.5	0.68			67	●	●		
12.5/40	2	0.68			67	●	●		
16/40	0.3	0.68			62	●	●		
16/40	0.5	0.68			62	●	●		
16/40	1	0.68			67	●	●		
16/40	1.3	0.68			67	●	●		
16/40	1.5	0.68			72	●	●		
10/70	0.3	0.68			62	●	●		
10/70	0.5	0.68			62	●	●		
10/70	1	0.68			67	●	●		
10/70	1.3	0.68			67	●	●		
10/70	1.5	0.68			72	●	●		
3/40	0.15	2 x 6800			10	0.68	58	●	●
12.5/40	0.47	2 x 25000			1.3	0.68	58	●	●
3/40	1	2 x 10000	1	0.47	80	●	●		
10/40	1	2 x 2200 to 2 x 27000	0.5	0.47	80	●	●		
10/40			1	0.47	80	●	●		
12.5/40			0.3	0.47	80	●	●		
12.5/40			0.5	0.47	80	●	●		
12.5/40			1	0.47	80	●	●		
12.5/40			1.3	0.47	80	●	●		
12.5/40			1.5	0.47	85	●	●		
16/40			0.3	0.47	80	●	●		
16/40			0.5	0.47	80	●	●		
16/40			1	0.47	85	●	●		
16/40			1.3	0.47	85	●	●		
16/40			1.5	0.47	90	●	●		
10/70			0.3	0.47	80	●	●		
10/70			0.5	0.47	80	●	●		
10/70			1	0.47	85	●	●		
10/70			1.3	0.47	85	●	●		
10/70			1.5	0.47	90	●	●		

#### NOMINAL VALUES FOR CAPACITANCE:

- \* 0.15 µF + 2 x 2200 pF
- 0.15 µF + 2 x 2200 pF
- \* 0.15 µF + 2 x 4700 pF
- 0.15 µF + 2 x 5000 pF
- 0.15 µF + 2 x 10000 pF
- 0.15 µF + 2 x 15000 pF

- \* 0.25 µF + 2 x 2200 pF
- 0.25 µF + 2 x 2700 pF
- \* 0.25 µF + 2 x 4700 pF
- 0.25 µF + 2 x 5000 pF
- \* 0.25 µF + 2 x 10000 pF
- \* 0.25 µF + 2 x 15000 pF
- 0.25 µF + 2 x 18000 pF
- \* 0.25 µF + 2 x 20000 pF
- \* 0.25 µF + 2 x 22000 pF
- 0.25 µF + 2 x 25000 pF
- 0.25 µF + 2 x 27000 pF

- \* 0.47 µF + 2 x 2200 pF
- \* 0.47 µF + 2 x 2700 pF
- 0.47 µF + 2 x 4700 pF
- 0.47 µF + 2 x 5000 pF
- 0.47 µF + 2 x 10000 pF
- \* 0.47 µF + 2 x 15000 pF
- 0.47 µF + 2 x 18000 pF
- \* 0.47 µF + 2 x 20000 pF
- 0.47 µF + 2 x 22000 pF
- 0.47 µF + 2 x 25000 pF
- 0.47 µF + 2 x 27000 pF

- 1 µF + 2 x 2200 pF
- 1 µF + 2 x 2700 pF
- 1 µF + 2 x 4700 pF
- 1 µF + 2 x 5000 pF
- 1 µF + 2 x 10000 pF
- 1 µF + 2 x 15000 pF
- 1 µF + 2 x 18000 pF
- 1 µF + 2 x 20000 pF
- 1 µF + 2 x 22000 pF
- 1 µF + 2 x 25000 pF
- 1 µF + 2 x 27000 pF

\* ONLY FOR IEC 60939-2

APPROVALS FOR CLIMATIC CATEGORY 40/100/56 ACCORDING TO IEC 60068-1

● APPROVALS IN USE

# FILTERS FOR RADIO INTERFERENCE SUPPRESSION TYPE KPL3023

CLASS X1Y2

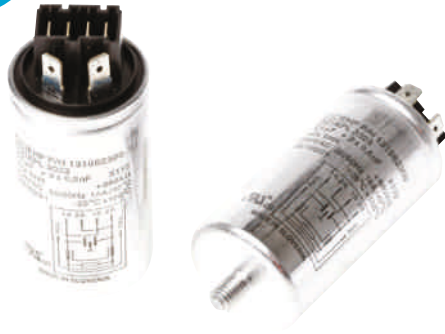

## ELECTRICAL CONNECTION

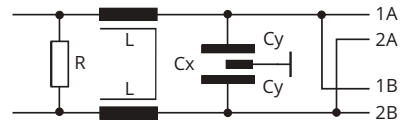

R = 470 k $\Omega$  - 2.7 M $\Omega$  ON REQUEST

KPL3023

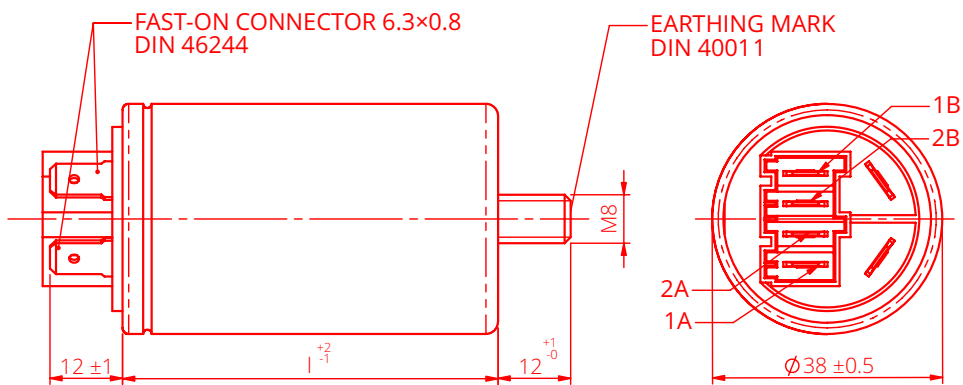

## TECHNICAL DATA

■ DIELECTRIC	PAPER IMPREGNATED
■ ELECTRODES	ALUMINIUM FOIL
■ RATED VOLTAGE	275 V AC
■ CAPACITANCE TOLERANCE	± 20 %
■ INDUCTANCE TOLERANCE	-30 % TO +50 %
■ TEST VOLTAGE	X1 CAPACITOR 1790 V DC, 2 s Y2 CAPACITOR 2050 V AC, 2 s (OR 3000 V DC, 2 s)
■ INSULATION RESISTANCE AT 20 °C , U <sub>m</sub> = 100 V DC, t = 1 min	R <sub>i</sub> ≥ 6000 M $\Omega$ FOR C ≤ 0.33 $\mu$ F R <sub>i</sub> x C <sub>n</sub> ≥ 2000 s FOR C > 0.33 $\mu$ F
■ COMPLIES TO	IEC/EN 60939-2, UL1283, CSA C22.2 No. 8 CAPACITOR PART TO IEC 60384-14

CASING: ALUMINIUM CAN,  
CLOSED WITH SEALING WASHER.



### TERMINALS

TYPE	TYPE OF TERMINALS
KPL3023	- 1A, 2A AND 1B, 2B FOR RAST 5 - 2 X FAST-ON CONNECTORS

# FILTERS FOR RADIO INTERFERENCE SUPPRESSION

## TYPE KPL3023

### STANDARD VALUES KPL 3023 FOR UPPER TEMPERATURE 100 °C

CURRENT I (A)/T(°C)	NOMINAL VALUES								
	X1 (µF)	Y2 (pF)	INDUCTANCE L (mH)	DISCHARGING RESISTOR R (mΩ)	DIMENSIONS L (mm)				
7/40	0.15	2 x 2200 to 2 x 15000	0.5	1.5	38	●	●		
7/40			1	1.5	47	●	●		
10/40			0.5	1.5	47	●	●		
10/40			1	1.5	47	●	●		
16/40	0.25	2 x 2200 to 2 x 27000	0.3	1	61	●	●		
16/40			0.5	1	61	●	●		
16/40			1	1	65	●	●		
16/40			1.5	1	75	●	●		
10/70			0.3	1	61	●	●		
10/70			0.5	1	61	●	●		
10/70			1	1	65	●	●		
10/70			1.5	1	75	●	●		
10/40			0.47	2 x 2200 to 2 x 27000	0.5	0.68	65	●	●
10/40					1	0.68	65	●	●
12.5/40	0.3	0.68			65	●	●		
12.5/40	0.5	0.68			65	●	●		
12.5/40	1	0.68			65	●	●		
12.5/40	1.3	0.68			65	●	●		
12.5/40	1.5	0.68			70	●	●		
12.5/40	2	0.68			70	●	●		
16/40	0.3	0.68			65	●	●		
16/40	0.5	0.68			65	●	●		
16/40	1	0.68			70	●	●		
16/40	1.3	0.68			70	●	●		
16/40	1.5	0.68			75	●	●		
10/70	0.3	0.68			65	●	●		
10/70	0.5	0.68			65	●	●		
10/70	1	0.68			70	●	●		
10/70	1.3	0.68			70	●	●		
10/70	1.5	0.68			75	●	●		
3/40	0.15	2 x 6800			10	0.68	61	●	●
12.5/40	0.47	2 x 25000			1.3	0.68	61	●	●
16/40	0.5	2 x 600	1	0.68	67	●	●		
3/40	1	2 x 10000	1	0.47	83	●	●		
10/40	1	2 x 2200 to 2 x 27000	0.5	0.47	83	●	●		
10/40			1	0.47	83	●	●		
12.5/40			0.3	0.47	83	●	●		
12.5/40			0.5	0.47	83	●	●		
12.5/40			1	0.47	83	●	●		
12.5/40			1.3	0.47	83	●	●		
12.5/40			1.5	0.47	88	●	●		
16/40			0.3	0.47	83	●	●		
16/40			0.5	0.47	83	●	●		
16/40			1	0.47	88	●	●		
16/40			1.3	0.47	88	●	●		
16/40			1.5	0.47	93	●	●		
10/70			0.3	0.47	83	●	●		
10/70			0.5	0.47	83	●	●		
10/70			1	0.47	88	●	●		
10/70			1.3	0.47	88	●	●		
10/70			1.5	0.47	93	●	●		

#### NOMINAL VALUES FOR CAPACITANCE:

- \* 0.15 µF + 2 x 2200 pF
- \* 0.15 µF + 2 x 2700 pF
- 0.15 µF + 2 x 4700 pF
- 0.15 µF + 2 x 5000 pF
- 0.15 µF + 2 x 10000 pF
- 0.15 µF + 2 x 15000 pF

- \* 0.25 µF + 2 x 2700 pF
- 0.25 µF + 2 x 4700 pF
- 0.25 µF + 2 x 5000 pF
- \* 0.25 µF + 2 x 10000 pF
- \* 0.25 µF + 2 x 15000 pF
- \* 0.25 µF + 2 x 18000 pF
- 0.25 µF + 2 x 20000 pF
- 0.25 µF + 2 x 22000 pF
- 0.25 µF + 2 x 25000 pF
- 0.25 µF + 2 x 27000 pF

- \* 0.47 µF + 2 x 2700 pF
- 0.47 µF + 2 x 4700 pF
- 0.47 µF + 2 x 5000 pF
- \* 0.47 µF + 2 x 10000 pF
- \* 0.47 µF + 2 x 15000 pF
- \* 0.47 µF + 2 x 18000 pF
- 0.47 µF + 2 x 20000 pF
- 0.47 µF + 2 x 22000 pF
- 0.47 µF + 2 x 25000 pF
- 0.47 µF + 2 x 27000 pF

- \* 1 µF + 2 x 2200 pF
- \* 1 µF + 2 x 2700 pF
- \* 1 µF + 2 x 4700 pF
- \* 1 µF + 2 x 5000 pF
- \* 1 µF + 2 x 10000 pF
- \* 1 µF + 2 x 15000 pF
- \* 1 µF + 2 x 18000 pF
- \* 1 µF + 2 x 20000 pF
- \* 1 µF + 2 x 22000 pF
- \* 1 µF + 2 x 25000 pF
- 1 µF + 2 x 27000 pF

\* ONLY FOR IEC 60939-2

APPROVALS FOR CLIMATIC CATEGORY 40/100/56 ACCORDING TO IEC 60068-1

● APPROVALS IN USE



# FILTERS FOR RADIO INTERFERENCE SUPPRESSION TYPE KPL3024

CLASS X1Y2



## ELECTRICAL CONNECTION

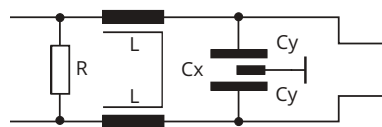

R = 470 kΩ - 2.7 MΩ ON REQUEST

KPL3024

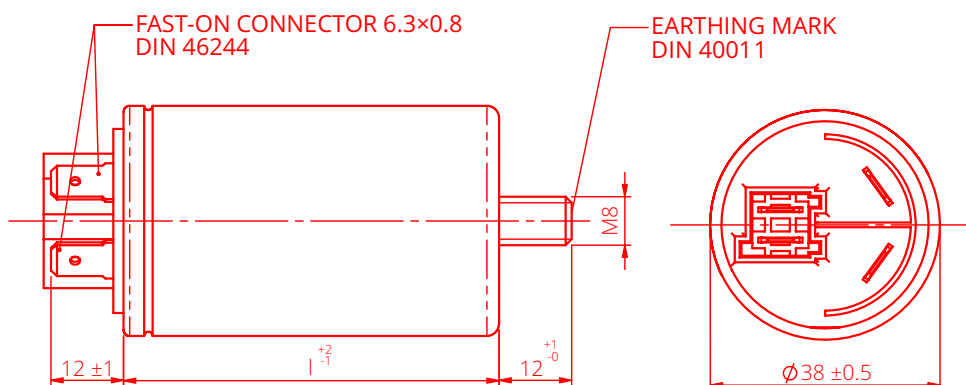

## TECHNICAL DATA

■ DIELECTRIC	PAPER IMPREGNATED
■ ELECTRODES	ALUMINIUM FOIL
■ RATED VOLTAGE	275 V AC
■ CAPACITANCE TOLERANCE	± 20 %
■ INDUCTANCE TOLERANCE	-30 % TO +50 %
■ TEST VOLTAGE	X1 CAPACITOR 1790 V DC, 2 s Y2 CAPACITOR 3000 V DC, 2 s (2050 V AC, 2 s)
■ INSULATION RESISTANCE AT 20 °C , U <sub>m</sub> = 100 V DC, t = 1 min	R <sub>i</sub> ≥ 6000 MΩ FOR C ≤ 0.33 μF R <sub>i</sub> x C <sub>n</sub> ≥ 2000 s FOR C > 0.33 μF
■ COMPLIES TO	IEC/EN 60939-2, UL1283, CSA C22.2 No. 8 CAPACITOR PART TO IEC 60384-14



CASING: ALUMINIUM CAN,  
CLOSED WITH SEALING WASHER.

### TERMINALS

TYPE	TYPE OF TERMINALS
KPL3024	- FOR RAST 5 - 2 X FAST-ON CONNECTORS

# FILTERS FOR RADIO INTERFERENCE SUPPRESSION TYPE KPL3024

## STANDARD VALUES KPL 3024 FOR UPPER TEMPERATURE 100 °C

CURRENT I (A)/T(°C)	NOMINAL VALUES								
	X1 (µF)	Y2 (pF)	INDUCTANCE L (mH)	DISCHARGING RESISTOR R (mΩ)	DIMENSIONS L (mm)				
7/40	0.15	2 x 2200 to 2 x 15000	0.5	1.5	38	●	●		
7/40			1	1.5	44	●	●		
10/40			0.5	1.5	44	●	●		
10/40			1	1.5	44	●	●		
16/40	0.25	2 x 2200 to 2 x 27000	0.3	1	58	●	●		
16/40			0.5	1	58	●	●		
16/40			1	1	62	●	●		
16/40			1.5	1	72	●	●		
10/70			0.3	1	58	●	●		
10/70			0.5	1	58	●	●		
10/70			1	1	62	●	●		
10/70			1.5	1	72	●	●		
10/40			0.47	2 x 2200 to 2 x 27000	0.5	0.68	62	●	●
10/40					1	0.68	62	●	●
12.5/40	0.3	0.68			62	●	●		
12.5/40	0.5	0.68			62	●	●		
12.5/40	1	0.68			62	●	●		
12.5/40	1.3	0.68			62	●	●		
12.5/40	1.5	0.68			67	●	●		
12.5/40	2	0.68			67	●	●		
16/40	0.3	0.68			62	●	●		
16/40	0.5	0.68			62	●	●		
16/40	1	0.68			67	●	●		
16/40	1.3	0.68			67	●	●		
16/40	1.5	0.68			72	●	●		
10/70	0.3	0.68			62	●	●		
10/70	0.5	0.68			62	●	●		
10/70	1	0.68			67	●	●		
10/70	1.3	0.68			67	●	●		
10/70	1.5	0.68			72	●	●		
3/40	0.15	2 x 6800			10	0.68	58	●	●
12.5/40	0.47	2 x 25000			1.3	0.68	58	●	●
16/40	0.5	2 x 600	1	0.68	67	●	●		
3/40	1	2 x 10000	1	0.47	80	●	●		
10/40	1	2 x 2200 to 2 x 27000	0.5	0.47	80	●	●		
10/40			1	0.47	80	●	●		
12.5/40			0.3	0.47	80	●	●		
12.5/40			0.5	0.47	80	●	●		
12.5/40			1	0.47	80	●	●		
12.5/40			1.3	0.47	80	●	●		
12.5/40			1.5	0.47	85	●	●		
16/40			0.3	0.47	80	●	●		
16/40			0.5	0.47	80	●	●		
16/40			1	0.47	85	●	●		
16/40			1.3	0.47	85	●	●		
16/40			1.5	0.47	90	●	●		
10/70			0.3	0.47	80	●	●		
10/70			0.5	0.47	80	●	●		
10/70			1	0.47	85	●	●		
10/70			1.3	0.47	85	●	●		
10/70			1.5	0.47	90	●	●		

### NOMINAL VALUES FOR CAPACITANCE:

- \* 0.15 µF + 2 x 2200 pF
- 0.15 µF + 2 x 2700 pF
- \* 0.15 µF + 2 x 4700 pF
- 0.15 µF + 2 x 5000 pF
- 0.15 µF + 2 x 10000 pF
- 0.15 µF + 2 x 15000 pF

- \* 0.25 µF + 2 x 2200 pF
- 0.25 µF + 2 x 2700 pF
- \* 0.25 µF + 2 x 4700 pF
- 0.25 µF + 2 x 5000 pF
- \* 0.25 µF + 2 x 10000 pF
- \* 0.25 µF + 2 x 15000 pF
- 0.25 µF + 2 x 18000 pF
- \* 0.25 µF + 2 x 20000 pF
- \* 0.25 µF + 2 x 22000 pF
- 0.25 µF + 2 x 25000 pF

- \* 0.47 µF + 2 x 2200 pF
- \* 0.47 µF + 2 x 2700 pF
- 0.47 µF + 2 x 4700 pF
- 0.47 µF + 2 x 5000 pF
- 0.47 µF + 2 x 10000 pF
- \* 0.47 µF + 2 x 15000 pF
- 0.47 µF + 2 x 18000 pF
- \* 0.47 µF + 2 x 20000 pF
- 0.47 µF + 2 x 22000 pF
- 0.47 µF + 2 x 25000 pF

- \* 1 µF + 2 x 2200 pF
- \* 1 µF + 2 x 2700 pF
- \* 1 µF + 2 x 4700 pF
- \* 1 µF + 2 x 5000 pF
- \* 1 µF + 2 x 10000 pF
- \* 1 µF + 2 x 15000 pF
- \* 1 µF + 2 x 18000 pF
- \* 1 µF + 2 x 20000 pF
- \* 1 µF + 2 x 22000 pF
- \* 1 µF + 2 x 25000 pF
- 1 µF + 2 x 27000 pF

● APPROVALS IN USE

APPROVALS FOR CLIMATIC CATEGORY 40/100/56 ACCORDING TO IEC 60068-1

● APPROVALS IN USE

# FILTERS FOR RADIO INTERFERENCE SUPPRESSION TYPE KPL3508

CLASS X1Y2



## ELECTRICAL CONNECTION

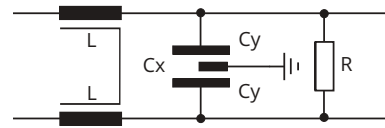

R = 470 k $\Omega$  - 2.7 M $\Omega$  ON REQUEST

CASING: THERMOPLASTIC CAN,  
SEALED WITH SYNTHETICAL  
RESIN, FLAME RETARDANT

## TERMINALS

TYPE	TYPE OF TERMINALS
KPL3508	FAST-ON CONNECTORS

KPL3508

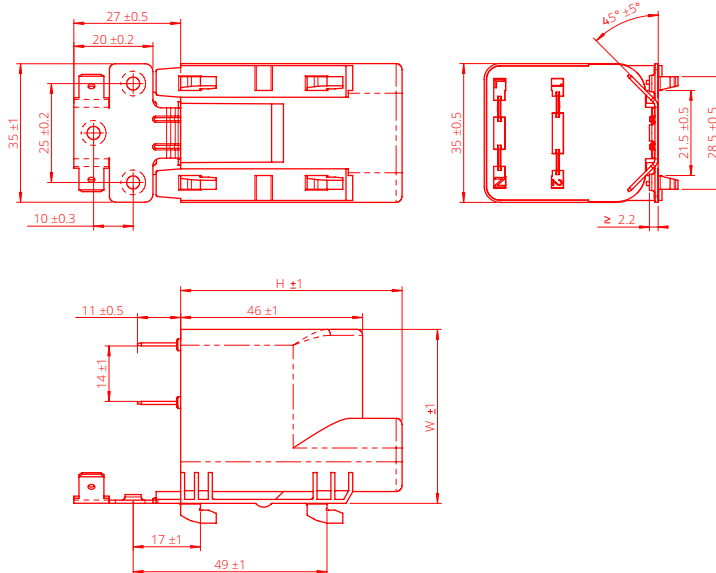



## TECHNICAL DATA

■ DIELECTRIC	PAPER IMPREGNATED
■ ELECTRODES	ALUMINIUM FOIL
■ RATED VOLTAGE	275 V AC
■ CAPACITANCE TOLERANCE	± 20 %
■ INDUCTANCE TOLERANCE	-30 % TO +50 %
■ TEST VOLTAGE	X1 CAPACITOR 1790 V DC, 2 s Y2 CAPACITOR 3000 V DC, 2 s (2050 V AC, 2 s)
■ INSULATION RESISTANCE AT 20 °C , U <sub>m</sub> = 100 V DC, t = 1 min	R <sub>i</sub> ≥ 6000 M $\Omega$ FOR C ≤ 0.33 $\mu$ F R <sub>i</sub> x C <sub>n</sub> ≥ 2000 s FOR C > 0.33 $\mu$ F
■ COMPLIES TO	IEC/EN 60939-2, UL1283, CSA C22.2 No. 8 CAPACITOR PART TO IEC 60384-14

# FILTERS FOR RADIO INTERFERENCE SUPPRESSION TYPE KPL3508

## STANDARD VALUES KPL 3508 FOR UPPER TEMPERATURE 100 °C

CURRENT I (A)/T(°C)	Nominal values							
	X1 (µF)	Y2 (pF)	INDUCTANCE L (mH)	DISCHARGING RESISTOR R (mΩ)	DIMENSIONS H (mm)	DIMENSIONS W (mm)		
10/40	0.25	2 x 2200 to 2 x 27000	0.47	1	46	41	●	●
10/40			0.5	1	46	41	●	●
10/40			1	1	46	41	●	●
10/40			1.8	1	46	41	●	●
12.5/40			0.3	1	46	41	●	●
12.5/40			0.47	1	46	41	●	●
12.5/40			1	1	46	41	●	●
12.5/40			1.3	1	46	41	●	●
12.5/40			1.5	1	46	41	●	●
12.5/40			1.8	1	46	41	●	●
16/40			0.3	1	46	41	●	●
16/40			0.47	1	46	41	●	●
16/40			1	1	46	41	●	●
10/70			0.3	1	46	41	●	●
10/70			0.47	1	46	41	●	●
10/70			1	1	46	41	●	●
10/40	0.33	2 x 2200 to 2 x 27000	0.47	0.68	46	41	●	●
10/40			0.5	0.68	46	41	●	●
10/40			1	0.68	46	41	●	●
10/40			1.8	0.68	46	41	●	●
12.5/40			0.3	0.68	46	41	●	●
12.5/40			0.47	0.68	46	41	●	●
12.5/40			1	0.68	46	41	●	●
12.5/40			1.3	0.68	46	41	●	●
12.5/40			1.5	0.68	46	41	●	●
12.5/40			1.8	0.68	46	41	●	●
16/40			0.3	0.68	46	41	●	●
16/40			0.47	0.68	46	41	●	●
16/40			1	0.68	46	41	●	●
10/70			0.3	0.68	46	41	●	●
10/70			0.47	0.68	46	41	●	●
10/70			1	0.68	46	41	●	●
10/40	0.47	2 x 2200 to 2 x 27000	0.47	0.68	46	41	●	●
10/40			0.5	0.68	46	41	●	●
10/40			1	0.68	46	41	●	●
10/40			1.8	0.68	46	41	●	●
12.5/40			0.3	0.68	46	41	●	●
12.5/40			0.47	0.68	46	41	●	●
12.5/40			1	0.68	46	41	●	●
12.5/40			1.3	0.68	46	41	●	●
12.5/40			1.5	0.68	46	41	●	●
12.5/40			1.8	0.68	46	41	●	●
16/40			0.3	0.68	46	41	●	●
16/40			0.47	0.68	46	41	●	●
16/40			1	0.68	46	41	●	●
10/70			0.3	0.68	46	41	●	●
10/70			0.47	0.68	46	41	●	●
10/70			1	0.68	46	41	●	●

### NOMINAL VALUES FOR CAPACITANCE:

0.25 µF + 2 x 2200 pF  
0.25 µF + 2 x 2700 pF  
0.25 µF + 2 x 4700 pF  
0.25 µF + 2 x 5000 pF  
0.25 µF + 2 x 10000 pF  
0.25 µF + 2 x 15000 pF  
0.25 µF + 2 x 20000 pF  
0.25 µF + 2 x 22000 pF  
0.25 µF + 2 x 25000 pF  
0.25 µF + 2 x 27000 pF

0.33 µF + 2 x 2200 pF  
0.33 µF + 2 x 2700 pF  
0.33 µF + 2 x 4700 pF  
0.33 µF + 2 x 5000 pF  
0.33 µF + 2 x 10000 pF  
0.33 µF + 2 x 15000 pF  
0.33 µF + 2 x 20000 pF  
0.33 µF + 2 x 22000 pF  
0.33 µF + 2 x 25000 pF



0.47 µF + 2 x 2200 pF  
0.47 µF + 2 x 2700 pF  
0.47 µF + 2 x 4700 pF  
0.47 µF + 2 x 5000 pF  
0.47 µF + 2 x 10000 pF  
0.47 µF + 2 x 15000 pF  
0.47 µF + 2 x 20000 pF  
0.47 µF + 2 x 22000 pF  
0.47 µF + 2 x 25000 pF

● APPROVALS IN USE

# FILTERS FOR RADIO INTERFERENCE SUPPRESSION

## TYPE KPL3508

### STANDARD VALUES KPL 3508 FOR UPPER TEMPERATURE 100 °C

CURRENT I (A)/T(°C)	NOMINAL VALUES							
	X1 (µF)	Y2 (pF)	INDUCTANCE L (mH)	DISCHARGING RESISTOR R (mΩ)	DIMENSIONS H (mm)	DIMENSIONS W (mm)		
10/40	0.56	2 x 2200 to 2 x 27000	0.47	0.68	56	44	●	
10/40			0.5	0.68	56	44	●	
10/40			1	0.68	56	44	●	
10/40			1.8	0.68	56	44	●	
12.5/40			0.3	0.68	56	44	●	
12.5/40			0.47	0.68	56	44	●	
12.5/40			1	0.68	56	44	●	
12.5/40			1.3	0.68	56	44	●	
12.5/40			1.5	0.68	56	44	●	
12.5/40			1.8	0.68	56	44	●	
16/40			0.3	0.68	56	44	●	
16/40			0.47	0.68	56	44	●	
16/40			1	0.68	56	44	●	
10/70			0.3	0.68	56	44	●	
10/70			0.47	0.68	56	44	●	
10/70			1	0.68	56	44	●	
10/40	0.68	2 x 2200 to 2 x 27000	0.47	0.68	56	44	●	●
10/40			0.5	0.68	56	44	●	●
10/40			1	0.68	56	44	●	●
10/40			1.8	0.68	56	44	●	●
12.5/40			0.3	0.68	56	44	●	●
12.5/40			0.47	0.68	56	44	●	●
12.5/40			1	0.68	56	44	●	●
12.5/40			1.3	0.68	56	44	●	●
12.5/40			1.5	0.68	56	44	●	●
12.5/40			1.8	0.68	56	44	●	●
16/40			0.3	0.68	56	44	●	●
16/40			0.47	0.68	56	44	●	●
16/40			1	0.68	56	44	●	●
10/70			0.3	0.68	56	44	●	
10/70			0.47	0.68	56	44	●	
10/70			1	0.68	56	44	●	
10/40	1	2 x 2200 to 2 x 27000	0.47	0.68	56	44	●	●
10/40			0.5	0.68	56	44	●	●
10/40			1	0.68	56	44	●	●
10/40			1.8	0.68	56	44	●	●
12.5/40			0.3	0.68	56	44	●	●
12.5/40			0.47	0.68	56	44	●	●
12.5/40			1	0.68	56	44	●	●
12.5/40			1.3	0.68	56	44	●	●
12.5/40			1.5	0.68	56	44	●	●
12.5/40			1.8	0.68	56	44	●	●
16/40			0.3	0.68	56	44	●	●
16/40			0.47	0.68	56	44	●	●
16/40			1	0.68	56	44	●	●
10/70			0.3	0.68	56	44	●	
10/70			0.47	0.68	56	44	●	
10/70			1	0.68	56	44	●	

#### NOMINAL VALUES FOR CAPACITANCE:

0.56 µF + 2 x 2200 pF  
 0.56 µF + 2 x 2700 pF  
 0.56 µF + 2 x 4700 pF  
 0.56 µF + 2 x 5000 pF  
 0.56 µF + 2 x 10000 pF  
 0.56 µF + 2 x 15000 pF  
 0.56 µF + 2 x 20000 pF  
 0.56 µF + 2 x 22000 pF  
 0.56 µF + 2 x 25000 pF  
 0.56 µF + 2 x 27000 pF

0.68 µF + 2 x 2200 pF  
 0.68 µF + 2 x 2700 pF  
 0.68 µF + 2 x 4700 pF  
 0.68 µF + 2 x 5000 pF  
 0.68 µF + 2 x 10000 pF  
 0.68 µF + 2 x 15000 pF  
 0.68 µF + 2 x 20000 pF  
 0.68 µF + 2 x 22000 pF  
 0.68 µF + 2 x 25000 pF

1 µF + 2 x 2200 pF  
 1 µF + 2 x 2700 pF  
 1 µF + 2 x 4700 pF  
 1 µF + 2 x 5000 pF  
 1 µF + 2 x 10000 pF  
 1 µF + 2 x 15000 pF  
 1 µF + 2 x 20000 pF  
 1 µF + 2 x 22000 pF  
 1 µF + 2 x 25000 pF

● APPROVALS IN USE

# FILTERS FOR RADIO INTERFERENCE SUPPRESSION

## TYPE KPL3523

CLASS X1Y2



### ELECTRICAL CONNECTION

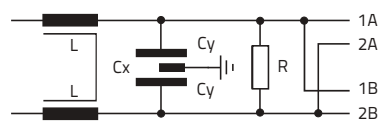

R = 470 k $\Omega$  - 2.7 M $\Omega$  on request

CASING: THERMOPLASTIC CAN,  
SEALED WITH SYNTHETICAL  
RESIN, FLAME RETARDANT

### TERMINALS

TYPE	TYPE OF TERMINALS
KPL3523	- 1A, 2A AND B1, 2B FOR RAST 5 - 2 X FAST-ON CONNECTORS

KPL3523

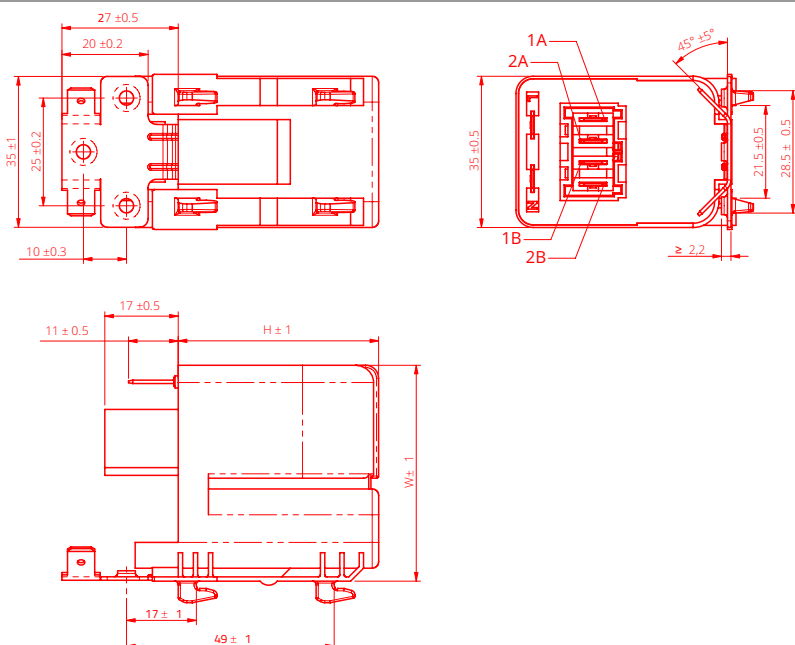



### TECHNICAL DATA

■ DIELECTRIC	PAPER IMPREGNATED
■ ELECTRODES	ALUMINIUM FOIL
■ RATED VOLTAGE	250 V AC, 275 V AC
■ CAPACITANCE TOLERANCE	$\pm 20\%$
■ INDUCTANCE TOLERANCE	-30 % TO +50 %
■ TEST VOLTAGE	X1 CAPACITOR 1790 V DC, 2 s Y2 CAPACITOR 3000 V DC, 2 s (2050 V AC, 2 s)
■ INSULATION RESISTANCE AT 20 °C, $U_m = 100$ V DC, $t = 1$ min	$R_i \geq 6000$ M $\Omega$ FOR $C \leq 0.33$ $\mu$ F $R_i \times C_n \geq 2000$ s FOR $C > 0.33$ $\mu$ F
■ COMPLIES TO	IEC/EN 60939-2, UL1283, CSA C22.2 No. 8 CAPACITOR PART TO IEC 60384-14

# FILTERS FOR RADIO INTERFERENCE SUPPRESSION TYPE KPL3523

## STANDARD VALUES KPL 3523 FOR UPPER TEMPERATURE 100 °C

CURRENT I (A)/T(°C)	NOMINAL VALUES							
	X1 (µF)	Y2 (pF)	INDUCTANCE L (mH)	DISCHARGING RESISTOR R (mΩ)	DIMENSIONS H (mm)	DIMENSIONS W (mm)		
10/40	0.25	2 x 2200 to 2 x 27000	0.47	1	46	50	●	●
10/40			0.5	1	46	50	●	●
10/40			1	1	46	50	●	●
10/40			1.8	1	46	50	●	●
12.5/40			0.3	1	46	50	●	●
12.5/40			0.47	1	46	50	●	●
12.5/40			1	1	46	50	●	●
12.5/40			1.3	1	46	50	●	●
12.5/40			1.5	1	46	50	●	●
12.5/40			1.8	1	46	50	●	●
16/40			0.3	1	46	50	●	●
16/40			0.47	1	46	50	●	●
16/40			1	1	46	50	●	●
10/70			0.3	1	46	50	●	●
10/70			0.47	1	46	50	●	●
10/70			1	1	46	50	●	●
10/40	0.33	2 x 2200 to 2 x 27000	0.47	0.68	46	50	●	●
10/40			0.5	0.68	46	50	●	●
10/40			1	0.68	46	50	●	●
10/40			1.8	0.68	46	50	●	●
12.5/40			0.3	0.68	46	50	●	●
12.5/40			0.47	0.68	46	50	●	●
12.5/40			1	0.68	46	50	●	●
12.5/40			1.3	0.68	46	50	●	●
12.5/40			1.5	0.68	46	50	●	●
12.5/40			1.8	0.68	46	50	●	●
16/40			0.3	0.68	46	50	●	●
16/40			0.47	0.68	46	50	●	●
16/40			1	0.68	46	50	●	●
10/70			0.3	0.68	46	50	●	●
10/70			0.47	0.68	46	50	●	●
10/70			1	0.68	46	50	●	●
10/40	0.47	2 x 2200 to 2 x 27000	0.47	0.68	46	50	●	●
10/40			0.5	0.68	46	50	●	●
10/40			1	0.68	46	50	●	●
10/40			1.8	0.68	46	50	●	●
12.5/40			0.3	0.68	46	50	●	●
12.5/40			0.47	0.68	46	50	●	●
12.5/40			1	0.68	46	50	●	●
12.5/40			1.3	0.68	46	50	●	●
12.5/40			1.5	0.68	46	50	●	●
12.5/40			1.8	0.68	46	50	●	●
16/40			0.3	0.68	46	50	●	●
16/40			0.47	0.68	46	50	●	●
16/40			1	0.68	46	50	●	●
10/70			0.3	0.68	46	50	●	●
10/70			0.47	0.68	46	50	●	●
10/70			1	0.68	46	50	●	●

### NOMINAL VALUES FOR CAPACITANCE:

0.25 µF + 2 x 2200 pF  
0.25 µF + 2 x 2700 pF  
0.25 µF + 2 x 4700 pF  
0.25 µF + 2 x 5000 pF  
0.25 µF + 2 x 10000 pF  
0.25 µF + 2 x 15000 pF  
0.25 µF + 2 x 20000 pF  
0.25 µF + 2 x 22000 pF  
0.25 µF + 2 x 25000 pF  
0.25 µF + 2 x 27000 pF



0.33 µF + 2 x 2200 pF  
0.33 µF + 2 x 2700 pF  
0.33 µF + 2 x 4700 pF  
0.33 µF + 2 x 5000 pF  
0.33 µF + 2 x 10000 pF  
0.33 µF + 2 x 15000 pF  
0.33 µF + 2 x 20000 pF  
0.33 µF + 2 x 22000 pF  
0.33 µF + 2 x 25000 pF

0.47 µF + 2 x 2200 pF  
0.47 µF + 2 x 2700 pF  
0.47 µF + 2 x 4700 pF  
0.47 µF + 2 x 5000 pF  
0.47 µF + 2 x 10000 pF  
0.47 µF + 2 x 15000 pF  
0.47 µF + 2 x 20000 pF  
0.47 µF + 2 x 22000 pF  
0.47 µF + 2 x 25000 pF

● APPROVALS IN USE

# FILTERS FOR RADIO INTERFERENCE SUPPRESSION TYPE KPL3523

## STANDARD VALUES KPL 3523 FOR UPPER TEMPERATURE 100 °C

CURRENT I (A)/T(°C)	Nominal values							
	X1 (μF)	Y2 (pF)	INDUCTANCE L (mH)	DISCHARGING RESISTOR R (mΩ)	DIMENSIONS H (mm)	DIMENSIONS W (mm)		
10/40	0.56	2 x 2200 to 2 x 27000	0.47	0.68	46	50	●	
10/40			0.5	0.68	46	50	●	
10/40			1	0.68	46	50	●	
10/40			1.8	0.68	46	50	●	
12.5/40			0.3	0.68	46	50	●	
12.5/40			0.47	0.68	46	50	●	
12.5/40			1	0.68	46	50	●	
12.5/40			1.3	0.68	46	50	●	
12.5/40			1.5	0.68	46	50	●	
12.5/40			1.8	0.68	46	50	●	
16/40			0.3	0.68	46	50	●	
16/40			0.47	0.68	46	50	●	
16/40			1	0.68	46	50	●	
10/70			0.3	0.68	46	50	●	
10/70			0.47	0.68	46	50	●	
10/70			1	0.68	46	50	●	
10/40	0.68	2 x 2200 to 2 x 27000	0.47	0.68	46	50	●	●
10/40			0.5	0.68	46	50	●	●
10/40			1	0.68	46	50	●	●
10/40			1.8	0.68	46	50	●	●
12.5/40			0.3	0.68	46	50	●	●
12.5/40			0.47	0.68	46	50	●	●
12.5/40			1	0.68	46	50	●	●
12.5/40			1.3	0.68	46	50	●	●
12.5/40			1.5	0.68	46	50	●	●
12.5/40			1.8	0.68	46	50	●	●
16/40			0.3	0.68	46	50	●	●
16/40			0.47	0.68	46	50	●	●
16/40			1	0.68	46	50	●	●
10/70			0.3	0.68	46	50	●	●
10/70			0.47	0.68	46	50	●	●
10/70			1	0.68	46	50	●	●
10/40	1	2 x 2200 to 2 x 27000	0.47	0.68	46	50	●	●
10/40			0.5	0.68	46	50	●	●
10/40			1	0.68	46	50	●	●
10/40			1.8	0.68	46	50	●	●
12.5/40			0.3	0.68	46	50	●	●
12.5/40			0.47	0.68	46	50	●	●
12.5/40			1	0.68	46	50	●	●
12.5/40			1.3	0.68	46	50	●	●
12.5/40			1.5	0.68	46	50	●	●
12.5/40			1.8	0.68	46	50	●	●
16/40			0.3	0.68	46	50	●	●
16/40			0.47	0.68	46	50	●	●
16/40			1	0.68	46	50	●	●
10/70			0.3	0.68	46	50	●	●
10/70			0.47	0.68	46	50	●	●
10/70			1	0.68	46	50	●	●
16/40	0.47	-	0.47	0.68	46	50	●	●

### NOMINAL VALUES FOR CAPACITANCE:

0.56 μF + 2 x 2200 pF  
0.56 μF + 2 x 2700 pF  
0.56 μF + 2 x 4700 pF  
0.56 μF + 2 x 5000 pF  
0.56 μF + 2 x 10000 pF  
0.56 μF + 2 x 15000 pF  
0.56 μF + 2 x 20000 pF  
0.56 μF + 2 x 22000 pF  
0.56 μF + 2 x 25000 pF  
0.56 μF + 2 x 27000 pF

0.68 μF + 2 x 2200 pF  
0.68 μF + 2 x 2700 pF  
0.68 μF + 2 x 4700 pF  
0.68 μF + 2 x 5000 pF  
0.68 μF + 2 x 10000 pF  
0.68 μF + 2 x 15000 pF  
0.68 μF + 2 x 20000 pF  
0.68 μF + 2 x 22000 pF  
0.68 μF + 2 x 25000 pF

1 μF + 2 x 2200 pF  
1 μF + 2 x 2700 pF  
1 μF + 2 x 4700 pF  
1 μF + 2 x 5000 pF  
1 μF + 2 x 10000 pF  
1 μF + 2 x 15000 pF  
1 μF + 2 x 20000 pF  
1 μF + 2 x 22000 pF  
1 μF + 2 x 25000 pF

● APPROVALS IN USE



# FILTERS FOR RADIO INTERFERENCE SUPPRESSION TYPE KPL3524

CLASS X1Y2



## ELECTRICAL CONNECTION

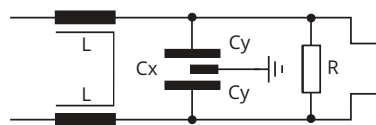

R = 470 kΩ - 2.7 MΩ ON REQUEST

CASING: THERMOPLASTIC CAN,  
SEALED WITH SYNTHETICAL  
RESIN, FLAME RETARDANT

## TERMINALS

TYPE	TYPE OF TERMINALS
KPL3524	- FOR RAST 5 - 2 X FAST-ON CONNECTORS

KPL3524

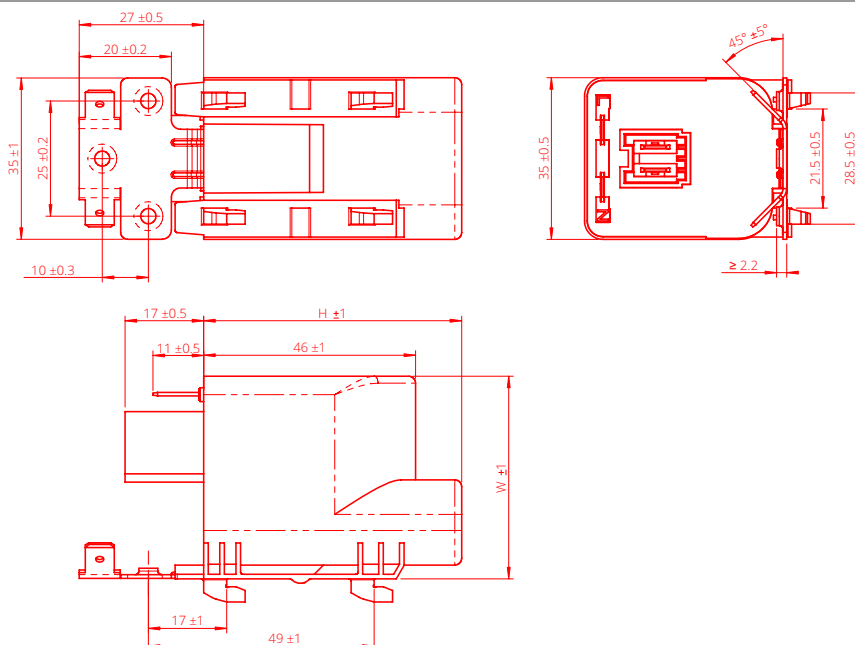



## TECHNICAL DATA

■ DIELECTRIC	PAPER IMPREGNATED
■ ELECTRODES	ALUMINIUM FOIL
■ RATED VOLTAGE	250 V AC, 275 V AC
■ CAPACITANCE TOLERANCE	± 20 %
■ INDUCTANCE TOLERANCE	-30 % TO +50 %
■ TEST VOLTAGE	X1 CAPACITOR 1790 V DC, 2 s Y2 CAPACITOR 3000 V DC, 2 s (2050 V AC, 2 s)
■ INSULATION RESISTANCE AT 20 °C, U <sub>m</sub> = 100 V DC, t = 1 min	R <sub>i</sub> ≥ 6000 MΩ FOR C ≤ 0.33 µF R <sub>i</sub> x C <sub>n</sub> ≥ 2000 s FOR C > 0.33 µF
■ COMPLIES TO	IEC/EN 60939-2, UL1283, CSA C22.2 No. 8 CAPACITOR PART TO IEC 60384-14

# FILTERS FOR RADIO INTERFERENCE SUPPRESSION

## TYPE KPL3524

### STANDARD VALUES KPL 3524 FOR UPPER TEMPERATURE 100 °C

CURRENT I (A)/T(°C)	Nominal values							
	X1 (µF)	Y2 (pF)	INDUCTANCE L (mH)	DISCHARGING RESISTOR R (mΩ)	DIMENSIONS H (mm)	DIMENSIONS W (mm)		
10/40	0.25	2 x 2200 to 2 x 27000	0.47	1	46	41	●	●
10/40			0.5	1	46	41	●	●
10/40			1	1	46	41	●	●
10/40			1.8	1	46	41	●	●
12.5/40			0.3	1	46	41	●	●
12.5/40			0.47	1	46	41	●	●
12.5/40			1	1	46	41	●	●
12.5/40			1.3	1	46	41	●	●
12.5/40			1.5	1	46	41	●	●
12.5/40			1.8	1	46	41	●	●
16/40			0.3	1	46	41	●	●
16/40			0.47	1	46	41	●	●
16/40			1	1	46	41	●	●
10/70			0.3	1	46	41	●	●
10/70			0.47	1	46	41	●	●
10/70			1	1	46	41	●	●
10/40	0.33	2 x 2200 to 2 x 27000	0.47	0.68	46	41	●	●
10/40			0.5	0.68	46	41	●	●
10/40			1	0.68	46	41	●	●
10/40			1.8	0.68	46	41	●	●
12.5/40			0.3	0.68	46	41	●	●
12.5/40			0.47	0.68	46	41	●	●
12.5/40			1	0.68	46	41	●	●
12.5/40			1.3	0.68	46	41	●	●
12.5/40			1.5	0.68	46	41	●	●
12.5/40			1.8	0.68	46	41	●	●
16/40			0.3	0.68	46	41	●	●
16/40			0.47	0.68	46	41	●	●
16/40			1	0.68	46	41	●	●
10/70			0.3	0.68	46	41	●	●
10/70			0.47	0.68	46	41	●	●
10/70			1	0.68	46	41	●	●
10/40	0.47	2 x 2200 to 2 x 27000	0.47	0.47	56	44	●	●
10/40			0.5	0.47	56	44	●	●
10/40			1	0.47	56	44	●	●
10/40			1.8	0.47	56	44	●	●
12.5/40			0.3	0.47	56	44	●	●
12.5/40			0.47	0.47	56	44	●	●
12.5/40			1	0.47	56	44	●	●
12.5/40			1.3	0.47	56	44	●	●
12.5/40			1.5	0.47	56	44	●	●
12.5/40			1.8	0.47	56	44	●	●
16/40			0.3	0.47	56	44	●	●
16/40			0.47	0.47	56	44	●	●
16/40			1	0.47	56	44	●	●
10/70			0.3	0.47	56	44	●	●
10/70			0.47	0.47	56	44	●	●
10/70			1	0.47	56	44	●	●

#### NOMINAL VALUES FOR CAPACITANCE:

0.25 µF + 2 x 2200 pF  
 0.25 µF + 2 x 2700 pF  
 0.25 µF + 2 x 4700 pF  
 0.25 µF + 2 x 5000 pF  
 0.25 µF + 2 x 10000 pF  
 0.25 µF + 2 x 15000 pF  
 0.25 µF + 2 x 20000 pF  
 0.25 µF + 2 x 22000 pF  
 0.25 µF + 2 x 25000 pF  
 0.25 µF + 2 x 27000 pF

0.33 µF + 2 x 2200 pF  
 0.33 µF + 2 x 2700 pF  
 0.33 µF + 2 x 4700 pF  
 0.33 µF + 2 x 5000 pF  
 0.33 µF + 2 x 10000 pF  
 0.33 µF + 2 x 15000 pF  
 0.33 µF + 2 x 20000 pF  
 0.33 µF + 2 x 22000 pF  
 0.33 µF + 2 x 25000 pF



0.47 µF + 2 x 2200 pF  
 0.47 µF + 2 x 2700 pF  
 0.47 µF + 2 x 4700 pF  
 0.47 µF + 2 x 5000 pF  
 0.47 µF + 2 x 10000 pF  
 0.47 µF + 2 x 15000 pF  
 0.47 µF + 2 x 20000 pF  
 0.47 µF + 2 x 22000 pF  
 0.47 µF + 2 x 25000 pF

● APPROVALS IN USE

# FILTERS FOR RADIO INTERFERENCE SUPPRESSION

## TYPE KPL3524

### STANDARD VALUES KPL 3524 FOR UPPER TEMPERATURE 100 °C

CURRENT I (A)/T(°C)	NOMINAL VALUES							
	X1 (µF)	Y2 (pF)	INDUCTANCE L (mH)	DISCHARGING RESISTOR R (mΩ)	DIMENSIONS H (mm)	DIMENSIONS W (mm)		
10/40	0.56	2 x 2200 to 2 x 27000	0.47	0.68	56	44	●	
10/40			0.5	0.68	56	44	●	
10/40			1	0.68	56	44	●	
10/40			1.8	0.68	56	44	●	
12.5/40			0.3	0.68	56	44	●	
12.5/40			0.47	0.68	56	44	●	
12.5/40			1	0.68	56	44	●	
12.5/40			1.3	0.68	56	44	●	
12.5/40			1.5	0.68	56	44	●	
12.5/40			1.8	0.68	56	44	●	
16/40			0.3	0.68	56	44	●	
16/40			0.47	0.68	56	44	●	
16/40			1	0.68	56	44	●	
10/70			0.3	0.68	56	44	●	
10/70			0.47	0.68	56	44	●	
10/70			1	0.68	56	44	●	
10/40	0.68	2 x 2200 to 2 x 27000	0.47	0.47	56	44	●	●
10/40			0.5	0.47	56	44	●	●
10/40			1	0.47	56	44	●	●
10/40			1.8	0.47	56	44	●	●
12.5/40			0.3	0.47	56	44	●	●
12.5/40			0.47	0.47	56	44	●	●
12.5/40			1	0.47	56	44	●	●
12.5/40			1.3	0.47	56	44	●	●
12.5/40			1.5	0.47	56	44	●	●
12.5/40			1.8	0.47	56	44	●	●
16/40			0.3	0.47	56	44	●	●
16/40			0.47	0.47	56	44	●	●
16/40			1	0.47	56	44	●	●
10/70			0.3	0.47	56	44	●	
10/70			0.47	0.47	56	44	●	
10/70			1	0.47	56	44	●	
10/40	1	2 x 2200 to 2 x 27000	0.47	0.47	56	44	●	●
10/40			0.5	0.47	56	44	●	●
10/40			1	0.47	56	44	●	●
10/40			1.8	0.47	56	44	●	●
12.5/40			0.3	0.47	56	44	●	●
12.5/40			0.47	0.47	56	44	●	●
12.5/40			1	0.47	56	44	●	●
12.5/40			1.3	0.47	56	44	●	●
12.5/40			1.5	0.47	56	44	●	●
12.5/40			1.8	0.47	56	44	●	●
16/40			0.3	0.47	56	44	●	●
16/40			0.47	0.47	56	44	●	●
16/40			1	0.47	56	44	●	●
10/70			0.3	0.47	56	44	●	
10/70			0.47	0.47	56	44	●	
10/70			1	0.47	56	44	●	

#### NOMINAL VALUES FOR CAPACITANCE:

0.56 µF + 2 x 2200 pF  
 0.56 µF + 2 x 2700 pF  
 0.56 µF + 2 x 4700 pF  
 0.56 µF + 2 x 5000 pF  
 0.56 µF + 2 x 10000 pF  
 0.56 µF + 2 x 15000 pF  
 0.56 µF + 2 x 20000 pF  
 0.56 µF + 2 x 22000 pF  
 0.56 µF + 2 x 25000 pF  
 0.56 µF + 2 x 27000 pF

0.68 µF + 2 x 2200 pF  
 0.68 µF + 2 x 2700 pF  
 0.68 µF + 2 x 4700 pF  
 0.68 µF + 2 x 5000 pF  
 0.68 µF + 2 x 10000 pF  
 0.68 µF + 2 x 15000 pF  
 0.68 µF + 2 x 20000 pF  
 0.68 µF + 2 x 22000 pF  
 0.68 µF + 2 x 25000 pF

1 µF + 2 x 2200 pF  
 1 µF + 2 x 2700 pF  
 1 µF + 2 x 4700 pF  
 1 µF + 2 x 5000 pF  
 1 µF + 2 x 10000 pF  
 1 µF + 2 x 15000 pF  
 1 µF + 2 x 20000 pF  
 1 µF + 2 x 22000 pF  
 1 µF + 2 x 25000 pF

● APPROVALS IN USE

# FILTERS FOR RADIO INTERFERENCE SUPPRESSION TYPE KPL3300

CLASS X1Y2

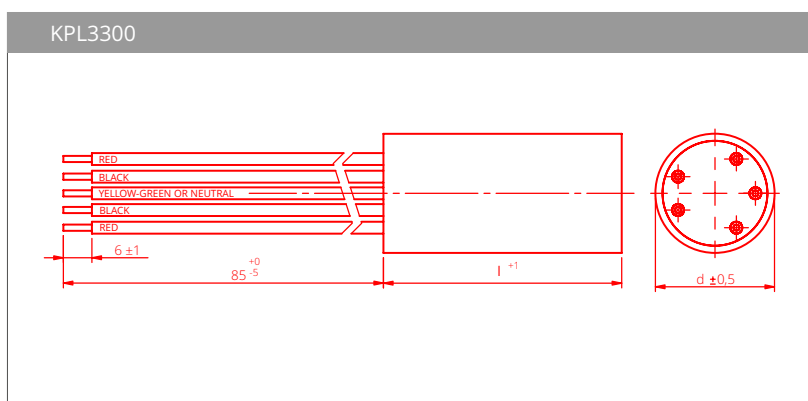
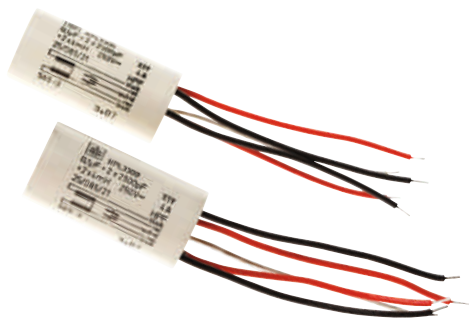

## ELECTRICAL CONNECTION

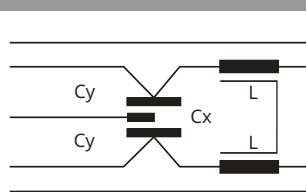

R = 470 kΩ - 2.7 MΩ ON REQUEST

## TECHNICAL DATA

■ CONSTRUCTION:	- CAPACITOR	PAPER IMPREGNATED
■ ELECTRODES		ALUMINIUM FOIL
■ RATED VOLTAGE		250 V AC, 275 V AC
■ CAPACITANCE TOLERANCE		± 20 %
■ INDUCTANCE TOLERANCE		-30% to +50 %
■ CLIMATIC CATEGORY		25/85/21 ACC. TO IEC 60068-1
■ TEMPERATURE RANGE		-25 ° TO +85 °C
■ TEST VOLTAGE		X1 - CAPACITOR 1625 V DC, 2 s FOR $U_R = 250$ V X1 - CAPACITOR 1790 V DC, 2 s FOR $U_R = 275$ V Y2 - CAPACITOR 2700 V DC, 2 s (OR 1800 V AC, 2 s)
■ INSULATION RESISTANCE AT 20 °C , $U_m = 100$ V DC, t = 1 min		$R_i \geq 6000$ MΩ FOR $C \leq 0.33$ μF $R_i \times C_{ii} \geq 2000$ s FOR $C > 0.33$ μF
■ COMPLIES TO		IEC/EN 60939-2, CAPACITOR SECTION IEC 60384-14

## STANDARD VALUES KPL3300

CURRENT I (A)	RATED VALUES			
	X1 (μF)	Y2 (pF)	INDUCTANCE L (mH)	DIMENSIONS d x l (mm)
4	0.1	2 x 2500	2 x 1	25 x 50
6	0.1	2 x 2500	2 x 1	25 x 50
3	0.1	2 x 2500	2 x 4	25 x 50
4	0.1	2 x 2500	2 x 2	25 x 50
2	0.1	2 x 2500	2 x 6	25 x 50

CASING: THERMOPLASTIC,  
SEALED WITH SYNTHETICAL RESIN.

### TERMINALS

TYPE	TYPE OF TERMINALS
KPL3300	STRANDED WIRE 0.5 mm <sup>2</sup> WITH PVC INSULATION

# FILTERS FOR RADIO INTERFERENCE SUPPRESSION TYPE KNL3524

CLASS X1Y2



## ELECTRICAL CONNECTION

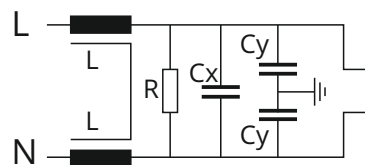

CASING: THERMOPLASTIC CAN, SEALED  
WITH SYNTHETICAL RESIN,  
FLAME RETARDANT

## TERMINALS

TYPE	TYPE OF TERMINALS
KNL3524	- FOR RAST 5 - 2 X FAST-ON CONNECTORS

KNL3524

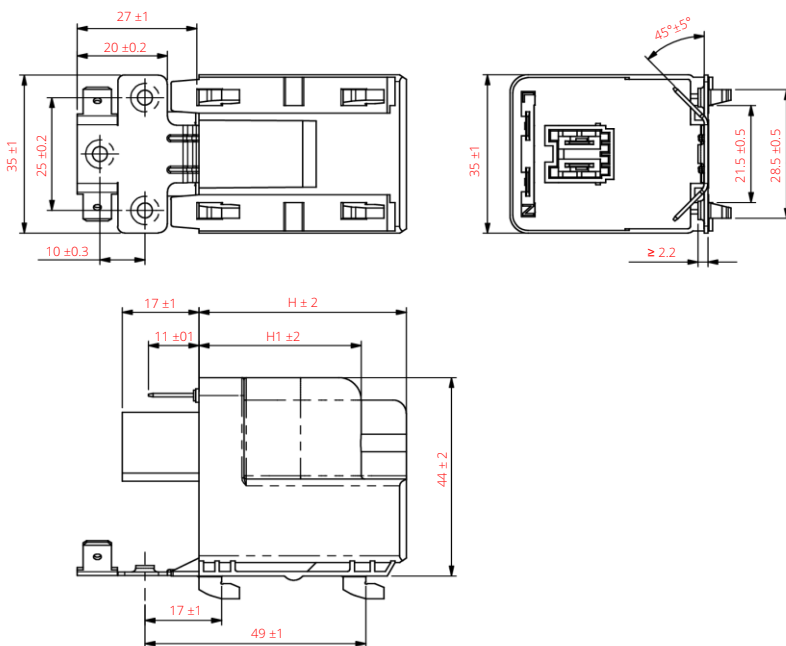



## TECHNICAL DATA

■ DIELECTRIC	POLYPROPYLENE FILM, METALLIZED
■ RATED VOLTAGE	250 V AC
■ CAPACITANCE TOLERANCE	± 20 %
■ INDUCTANCE TOLERANCE	-30 % TO +50 %
■ TEST VOLTAGE	X1 CAPACITOR 1625 V DC, 2 s Y2 CAPACITOR 3000 V DC, 2 s (2050 V AC, 2 s)
■ INSULATION RESISTANCE AT 20 °C, U <sub>m</sub> = 100 V DC, t = 1 min	R <sub>i</sub> ≥ 6000 MΩ FOR C ≤ 0.33 μF R <sub>i</sub> x C <sub>n</sub> ≥ 2000 s FOR C > 0.33 μF
■ COMPLIES TO	IEC/EN 60939-2, UL1283, CSA C22.2 No. 8 CAPACITOR PART TO IEC 60384-14

# FILTERS FOR RADIO INTERFERENCE SUPPRESSION

## TYPE KNL3524

### STANDARD VALUES KNL 3524



CURRENT I (A)/T(°C)	RATED VALUES								RATED CAPACITANCE VALUES		
	X1 (µF)	Y2 (pF) OPTIONAL	INDUCTANCE L (mH)	DISCHARGING RESISTOR R (mΩ)	DIMENSIONS H (mm)	DIMENSIONS W (mm)			Cx (µF)	+ 2 x	Cy (pF)
10/40	0.33	2 x 2200 up to 2 x 27000	0.3	0.68	46	37	●	○			
10/40			0.47	0.68	46	37	●	○			
10/40			0.5	0.68	46	37	●	○			
10/40			1	0.68	46	46	●	○			
10/40			1.3	0.68	46	46	●	○			
10/40			1.5	0.68	46	46	●	○	0.33	+ 2 x	2200
10/40			1.8	0.68	46	46	●	○	0.33	+ 2 x	2700
12.5/40			0.3	0.68	46	37	●	○	0.33	+ 2 x	4700
12.5/40			0.47	0.68	46	37	●	○	0.33	+ 2 x	5000
12.5/40			0.5	0.68	46	37	●	○	0.33	+ 2 x	10000
12.5/40			1	0.68	46	46	●	○	0.33	+ 2 x	15000
12.5/40			1.3	0.68	46	46	●	○	0.33	+ 2 x	20000
12.5/40			1.5	0.68	46	46	●	○	0.33	+ 2 x	22000
12.5/40			1.8	0.68	46	46	●	○	0.33	+ 2 x	25000
16/40 or 10/70			0.3	0.68	46	37	●	○	0.33	+ 2 x	27000
16/40 or 10/70			0.47	0.68	46	37	●	○			
16/40 or 10/70			0.5	0.68	46	37	●	○			
16/40 or 10/70			1	0.68	46	46	●	○			
16/40 or 10/70			1.3	0.68	46	46	●	○			
16/40 or 10/70			1.5	0.68	46	46	●	○			
16/40 or 10/70	1.8	0.68	46	46	●	○					
10/40	0.47	2 x 2200 up to 2 x 27000	0.3	0.68	46	37	●	○			
10/40			0.47	0.68	46	37	●	○			
10/40			0.5	0.68	46	37	●	○			
10/40			1	0.68	46	46	●	○			
10/40			1.3	0.68	46	46	●	○			
10/40			1.5	0.68	46	46	●	○	0.47	+ 2 x	2200
10/40			1.8	0.68	46	46	●	○	0.47	+ 2 x	2700
12.5/40			0.3	0.68	46	37	●	○	0.47	+ 2 x	4700
12.5/40			0.47	0.68	46	37	●	○	0.47	+ 2 x	5000
12.5/40			0.5	0.68	46	37	●	○	0.47	+ 2 x	10000
12.5/40			1	0.68	46	46	●	○	0.47	+ 2 x	15000
12.5/40			1.3	0.68	46	46	●	○	0.47	+ 2 x	20000
12.5/40			1.5	0.68	46	46	●	○	0.47	+ 2 x	22000
12.5/40			1.8	0.68	46	46	●	○	0.47	+ 2 x	25000
16/40 or 10/70			0.3	0.68	46	37	●	○	0.47	+ 2 x	22000
16/40 or 10/70			0.47	0.68	46	37	●	○			
16/40 or 10/70			0.5	0.68	46	37	●	○			
16/40 or 10/70			1	0.68	46	46	●	○			
16/40 or 10/70			1.3	0.68	46	46	●	○			
16/40 or 10/70			1.5	0.68	46	46	●	○			
16/40 or 10/70	1.8	0.68	46	46	●	○					

- APPROVALS IN USE
- APPROVALS IN PENDING

# FILTERS FOR RADIO INTERFERENCE SUPPRESSION

## TYPE KNL3524

### STANDARD VALUES KNL 3524

CURRENT I (A)/T(°C)	RATED VALUES								RATED CAPACITANCE VALUES				
	X1 (µF)	Y2 (pF) OPTIONAL	INDUCTANCE L (mH)	DISCHARGING RESISTOR R (mΩ)	DIMENSIONS H (mm)	DIMENSIONS W (mm)			Cx (µF)	+ 2 x	Cy (pF)		
10/40	0.68	2 x 1000 up to 2 x 27000	0.3	0.47	46	46	●	○					
10/40			0.47	0.47	46	46	●	○					
10/40			0.5	0.47	46	46	●	○					
10/40			1	0.47	46	46	●	○					
10/40			1.3	0.47	46	46	●	○	0.68	+ 2 x	1000		
10/40			1.5	0.47	46	46	●	○	0.68	+ 2 x	2200		
10/40			1.8	0.47	46	46	●	○	0.68	+ 2 x	2700		
12.5/40					0.3	0.47	46	46	●	○	0.68	+ 2 x	4700
12.5/40					0.47	0.47	46	46	●	○	0.68	+ 2 x	5000
12.5/40					0.5	0.47	46	46	●	○	0.68	+ 2 x	10000
12.5/40					1	0.47	46	46	●	○	0.68	+ 2 x	15000
12.5/40					1.3	0.47	46	46	●	○	0.68	+ 2 x	20000
12.5/40					1.5	0.47	46	46	●	○	0.68	+ 2 x	22000
12.5/40					1.8	0.47	46	46	●	○	0.68	+ 2 x	25000
16/40 or 10/70					0.3	0.47	46	46	●	○	0.68	+ 2 x	27000
16/40 or 10/70					0.47	0.47	46	46	●	○			
16/40 or 10/70					0.5	0.47	46	46	●	○			
16/40 or 10/70					1	0.47	46	46	●	○			
16/40 or 10/70					1.3	0.47	46	46	●	○			
16/40 or 10/70					1.5	0.47	46	46	●	○			
16/40 or 10/70			1.8	0.47	46	46	●	○					
10/40	1	2 x 1000 up to 2 x 27000	0.3	0.47	46	46	●	○					
10/40			0.47	0.47	46	46	●	○					
10/40			0.5	0.47	46	46	●	○					
10/40			1	0.47	46	46	●	○					
10/40			1.3	0.47	46	46	●	○	1	+ 2 x	1000		
10/40			1.5	0.47	46	46	●	○	1	+ 2 x	2200		
10/40			1.8	0.47	46	46	●	○	1	+ 2 x	2700		
12.5/40					0.3	0.47	46	46	●	○	1	+ 2 x	4700
12.5/40					0.47	0.47	46	46	●	○	1	+ 2 x	5000
12.5/40					0.5	0.47	46	46	●	○	1	+ 2 x	10000
12.5/40					1	0.47	46	46	●	○	1	+ 2 x	15000
12.5/40					1.3	0.47	46	46	●	○	1	+ 2 x	20000
12.5/40					1.5	0.47	46	46	●	○	1	+ 2 x	22000
12.5/40					1.8	0.47	46	46	●	○	1	+ 2 x	25000
16/40 or 10/70					0.3	0.47	46	46	●	○	1	+ 2 x	22000
16/40 or 10/70					0.47	0.47	46	46	●	○			
16/40 or 10/70					0.5	0.47	46	46	●	○			
16/40 or 10/70					1	0.47	46	46	●	○			
16/40 or 10/70					1.3	0.47	46	46	●	○			
16/40 or 10/70					1.5	0.47	46	46	●	○			
16/40 or 10/70			1.8	0.47	46	46	●	○					

- APPROVALS IN USE
- APPROVALS IN PENDING

# FILTERS FOR RADIO INTERFERENCE SUPPRESSION

## TYPE KNL4524

CLASS X1Y2



### ELECTRICAL CONNECTION

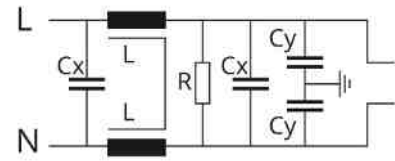

CASING: THERMOPLASTIC CAN, SEALED WITH SYNTHETICAL RESIN, FLAME RETARDANT

### TERMINALS

TYPE	TYPE OF TERMINALS
KNL4524	- FOR RAST 5 - 2 X FAST-ON CONNECTORS

### KNL4524

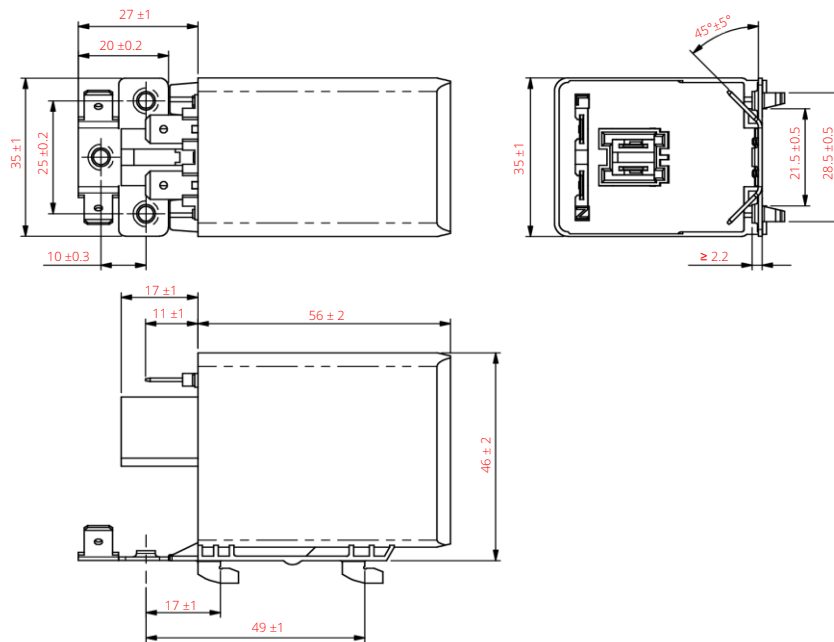

### TECHNICAL DATA

■ DIELECTRIC	POLYPROPYLENE FILM, METALLIZED
■ RATED VOLTAGE	250 V AC
■ CAPACITANCE TOLERANCE	± 20 %
■ INDUCTANCE TOLERANCE	-30 % TO +50 %
■ TEST VOLTAGE	X1 CAPACITOR 1625 V DC, 2 s Y2 CAPACITOR 3000 V DC, 2 s (2050 V AC, 2 s)
■ INSULATION RESISTANCE AT 20 °C, U <sub>m</sub> = 100 V DC, t = 1 min	R <sub>i</sub> ≥ 6000 MΩ FOR C ≤ 0.33 μF R <sub>x</sub> C <sub>n</sub> ≥ 2000 s FOR C > 0.33 μF
■ COMPLIES TO	IEC/EN 60939-2, UL1283, CSA C22.2 No. 8 CAPACITOR PART TO IEC 60384-14



# FILTERS FOR RADIO INTERFERENCE SUPPRESSION TYPE KNL4524

## STANDARD VALUES KNL 4524

CURRENT I (A)/T(°C)	RATED CAPACITANCE VALUES			RATED INDUCTANCE L (mH)	DISCHARGE RESISTOR MΩ	 IEC 60939-2
	C <sub>x1</sub> (μF)	C <sub>x2</sub> (μF)	C <sub>y</sub> (pF)			
10/40				0.3		●
10/40				0.47		●
10/40				0.5		●
10/40				1		●
10/40				1.3		●
10/40				1.5		●
10/40			2 x 4700	1.8		●
10/40			or	2		●
10/40			2 x 5000	2.5		●
10/40			or	0.3		●
12.5/40	0.33	0.33	2 x 10000	0.47	0.18	●
12.5/40	or	or	or	0.5	or	●
12.5/40	0.47	0.47	2 x 15000	1	0.33	●
12.5/40	or	or	or	1.3	or	●
12.5/40	0.68	0.68	2 x 20000	1.5	0.47	●
12.5/40	or	or	or	1.8	or	●
12.5/40	1	1	2 x 22000	2	0.68	●
12.5/40			or	2.5		●
16/40 or 10/70			2 x 25000	0.3		●
16/40 or 10/70			or	0.47		●
16/40 or 10/70			2 x 27000	0.5		●
16/40 or 10/70				1		●
16/40 or 10/70				1.3		●
16/40 or 10/70				1.5		●
16/40 or 10/70				1.8		●
16/40 or 10/70				2		●

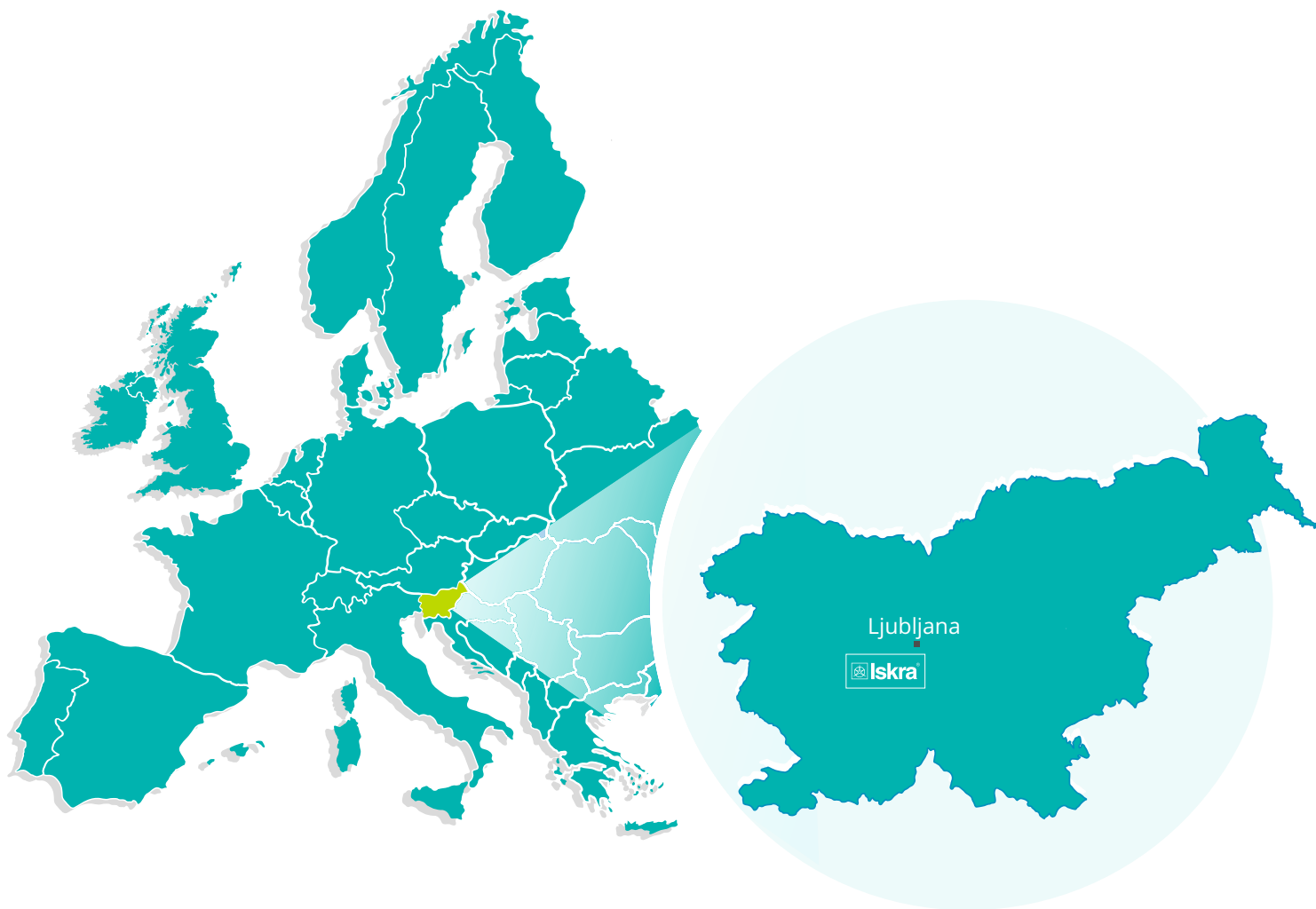

#### Headquarter

Stegne 21  
SI-1000, Ljubljana  
Phone: +386 1 513 10 00

#### BU Kondenzatorji

Vajdova ulica 71  
SI-8333, Semič  
Phone: +386 7 38 49 200

#### BU MIS

Ljubljanska c. 24a  
SI-4000, Kranj  
Phone: +386 4 237 21 12

#### PE Baterije in potenciometri

Šentvid pri Stični 108  
SI-1296, Šentvid pri Stični  
Phone: +386 1 780 08 00

#### PE Galvanotehnika

Glinek 5  
SI-1291, Škofljica  
Phone: +386 1 366 80 50

#### Iskra IP, d.o.o.

Vajdova ulica 71  
SI-8333, Semič  
Phone: +386 7 384 94 54

#### Iskra Lotrič, d.o.o.

Otoče 5a  
SI-4244, Podnart  
Phone: +386 4 535 91 68

#### Iskra ODM, d.o.o.

Otoče 5a  
4244, Podnart  
Phone: +386 4 237 21 96

#### Iskra STIK, d.o.o.

Ljubljanska cesta 24a  
SI-4000, Kranj  
Phone: +386 4 237 22 33

#### Iskra Tela L, d.o.o.

Omladinska 66  
78250, Laktaši  
Phone: +387 51 535 890

#### Iskra Sistemi - M dooel

Ul, Dame Grujev br. 16/5 kat  
1000, Skopje  
Phone: +389 75 444 498

#### Iskra Commerce, d.o.o.

Hadži Nikole Živkoviča br. 2  
11000, Beograd  
Phone: +381 11 328 10 41

#### Iskra Hong Kong Ltd.

33 Canton Road, T.S.T.  
1705, China HK City  
Phone: +852 273 00 917  
+852 273 01 020

#### Iskra INDIA Pvt Ltd.

3 shree Ganesh Glory  
Appartment Nakshtra  
Colony Near Akashwani  
Kendra, Nashik  
Phone: +91 253 2346161  
+91 909 6900893



**Iskra, d.o.o.**  
Stegne 21  
SI-1000 Ljubljana, Slovenia

Phone: +386 (0) 1 513 10 00  
[www.iskra.eu](http://www.iskra.eu)