



POWER QUALITY ANALYZER iMC784A

- **CLASS A** ACCURACY CERTIFIED.
- EN 50160 **POWER QUALITY EVALUATION**.
- AUTOMATIC **PQ REPORT** GENERATION.
- DISTURBANCE, TREND & PQ EVENT RECORDING.
- WAVEFORM RECORDER WITH PROGRAMMABLE SAMPLING TIME.
- STANDARDIZED PQDIF AND COMTRADE FORMAT SUPPORT.
- SUPPORT FOR **MODBUS, DNP3, FTP, MQTT, IEC61850 ED.2 COMMUNICATION PROTOCOLS**.
- **MIQEN** USER FRIENDLY SETTING & ANALYSIS SOFTWARE.

FEATURES

- Evaluation of the electricity supply quality in compliance with EN50160 with automatic report generation.
- Class A (0.1%) accuracy in compliance with EN61000-4-30 Ed.3.
- Instantaneous evaluation of over 700 electrical measurement quantities values including PQ related parameters, harmonics (voltage/current THDs, TDDs, up to 63rd voltage (PP, PN) /current harmonics and inter-harmonics).
- Automatic range selection of 4 current and 4 voltage channels (max. 12.5 A and 1000 V_{RMS}) with 32 kHz sampling rate.
- Oscillography capability for recording waveforms and transients with up to 625 samples/cycle sampling frequency.
- Recording of waveform, disturbance, trend and Power Quality (PQ) events in trigger related recorders.
- All trigger related recorder data available on-demand through FTP.
- A sophisticated triggering mechanism to register and record events of various nature:
 - Current and voltage transient event generated triggers based on hold-off time (in milliseconds), absolute peak value (% of U_n) and fast change (in % U_n/μs).
 - PQ event generated triggers based on the following events: voltage dip, voltage swell, voltage interruption, end of voltage interruption, rapid voltage change and inrush current.
 - External Ethernet triggers enabling trigger events with up to 8 different devices within the network.
 - External digital triggers based on logical/digital inputs.
 - Up to 16 combined triggers enabling logical operation on previously configured triggers of various nature.
- Recording a wide variety of data in the internal device 8 GB flash memory based on trigger settings:
 - All activated triggers together with timestamp, duration, condition as well as a reference to an (optionally) generated transient, waveform, disturbance and fast trend record.
 - Waveform recorder with PQDIF/COMTRADE data format selection, selectable recorded channels (4×Voltage, 4×Current, 16×Logical input), 19 samples/cycle to 625 samples/cycle resolution, pre-trigger time from 0.01 s up to 1 s, post-trigger time from 0.01 s up to 40 s (20 s for 625 samples/cycle).
 - Disturbance recorder with PQDIF/COMTRADE data format selection, selectable recorded channels (4×P-N Voltage, 3×P-P Voltage, 4×Current, 8×Logical inputs), half/full cycle averaging interval, pre-trigger time up to 3000 cycles, post trigger time up to 60000 cycles.
- Periodic measurements in 4 standard trend recorders A through D each containing up to 32 arbitrarily evaluated (maximum, minimum, average, maximum demand, minimum demand, actual, maximum period, minimum period) quantities with periods ranging from 1 min to 60 min.
- Periodic measurements in advanced fast trend recorders 1 through 4 each containing over 700 arbitrarily evaluated (maximum, minimum, average, actual) quantities with periods ranging from 1 s to 60 min. The recorder can be set to PQDIF data format selection.
- 32 adjustable alarms in 4 alarm groups each containing up to 8 alarms. Alarms relate to a particular quantity over/under threshold and serve the purpose of controlling on-device relay outputs as well as informing the server about the occurrence of alarm events.
- Recording and on-board evaluation of PQ anomalies and PQ reports based on EN50160.
- Four-quadrant energy measurement in eight programmable counters with class 0.2S accuracy with up to four tariffs and an advanced tariff clock. Every counter resolution and range can be defined:
 - Active energy import (Wh).
 - Active energy export (Wh).
 - Reactive energy import (varh).
 - Reactive energy export (varh).
 - Total absolute active energy (Wh).
 - Total absolute reactive energy (varh).
 - Total absolute apparent energy (VAh).
 - Custom settings (phase dependent, four quadrant – P/Q/import/export selection).
- Measurements of 40 minimal and maximal values in different time intervals (from 1 to 256 periods).
- Frequency range from 16 Hz to 400 Hz.
- Ethernet and USB 2.0 communication support.
- Communication – MODBUS, DNP3, FTP, MQTT, upgradeable to IEC61850 Ed.2 (To order the option of IEC61850 Ed.2 Server please order the following additional SW option number: 022491017000).
- Support for GPS, IRIG-B (modulated and digital) and NTP real time clock synchronization.
- Up to 4 inputs/outputs on I/O module 1/2 and 3/4 (analogue inputs/outputs, digital inputs/outputs, alarm/watchdog outputs, pulse input/outputs, tariff inputs, bistable alarm outputs, relay output).
- Up to 20 inputs/outputs on I/O module A and B (relay output, digital input).
- MiQEN Setting studio User-friendly setting and analysis software with FTP communication feasibility for seamless device settings and single device advanced analysis.
- On-board Web server support for basic measurement overview.
- Multilingual support (pixel display iMC784A only).

- Auxiliary power supply (two voltage ranges).
- 144 mm square panel mounting.
- Available with:
 - 5.7 inch color TFT display (iMC784A).
 - 128x64 pixel display (iMC784A).

DESCRIPTION

Power Quality Analyzer iMC784A is an important device for permanent monitoring of power quality from its production (especially renewable), transmission and distribution all the way to the final consumers. Lack of information about supplied quality of voltage can lead to unexplained production problems and malfunction or even damage to equipment used in production process. Therefore, Power Quality Analyzer iMC784A can be used for utility purposes (evaluation against standards) as well as for industry purposes (monitoring supplied power quality).

Power Quality Analyzer iMC784A performs measurements in compliance with regulatory requested standard EN 61000-4-30 Ed.3 and evaluates recorded parameters for analysis according to parameters defined in European power quality standard EN50160.

The device enables storage of a wide variety of highly detailed oscillography data in 8 GB of internal flash memory based on a sophisticated trigger settings mechanism. Data can be stored in standardized PQDIF (IEEE 1159-3) and COMTRADE (IEEE C37.111) file formats, which can be easily, exchanged with third party PQ analysis SW systems.

Moreover, Power Quality Analyzer iMC784A stores measurements and quality reports in internal memory for further analysis. By accessing recorded or real time values from multiple instruments installed on different locations, it is possible to gain the overall picture of the complete systems' behavior. This can be achieved with regard to Power Quality Analyzer iMC784A accurate internal real time clock and wide range of synchronization sources support, which assure accurate, time-stamped measurements from dislocated units.

Stored data can then be transferred to a PC or server for post analysis. The simplest way this is done is by directly connecting a PC with installed MiQEN Setting Studio SW via USB cable.

APPLICATION AND BENEFITS

Power Quality Analyzer iMC784A can be used as a standalone PQ monitoring device for detection and analysis of local PQ deviations, transients, alarms and periodic measurements. For this purpose, it is normally positioned at the point-of-common-coupling (PCC) of industrial and commercial energy consumers to monitor quality of delivered electric energy or at medium or low voltage feeders to monitor, detect and record possible disturbances caused by operation of consumers.

Identifying relevant fixed measuring points is the most important task prior to complete system installation. The implementation of a PQ system itself will not prevent disturbances in network but rather help diagnose their origins and effects by comparing and scrutinizing data from multiple time synchronized measurement points.

Server database records (with a copy in device memory) include numerous parameters of three-phase systems, which have been setup in the device (PQ parameters, over 700 evaluated electrical quantities, I/O module related physical parameters (e.g. temp., pressure, wind speed...)). On the other hand, the database also holds data on alarms and detailed time-stamped transient, waveform, disturbance PQ data and fast trend trigger records with complete oscillography data in standardized PQDIF/COMTRADE file formats.

COMPLIANCE WITH STANDARDS

Measurements and reports of power (voltage) quality (PQ) indexes are only useful when comparable to measurements and reports from other PQ measuring devices in the supply network and evaluated against agreed limits for assessment of measured PQ indices to establish an overall view about PQ issues in the network.

For this reason, it is essential to follow guidelines described in series of international and local standards. Beside requirements for safe operation (LVD directive) and immunity against more and more demanding disturbances (EMC directive), PQ measuring depends on two levels of standardization:

- Procedures for proper acquirement of PQ indexes, their timed aggregation and required accuracy are described in a standard IEC EN 61000-4-30 and two supplementary standards IEC EN 61000-4-7 (harmonics), IEC EN 61000-4-15 (flicker meter).
- Procedures for evaluation of measured PQ indices according to limit levels described in European standard EN50160.

Power Quality Analyzer iMC784A follows required procedures and meets the precision requirements for class A measuring device as described in standard IEC EN 61000-4-30. It uses acquired measurements to perform automatic evaluation of PQ according to EN50160 and issues weekly reports within the device itself. If certain PQ indices fail to meet the required power, quality levels the device highlights details of problematic anomaly events, together with their corresponding timestamps and a detailed waveform/transient or disturbance record for further thorough analysis of the occurred PQ non-compliant event.

Standard EN	Description
61010-1	Safety requirements for electrical equipment for measurement, control and laboratory use.
61557-12	Electrical safety in LV distribution systems up to 1 kV a.c. and 1.5 kV d.c. – Combined performance measuring and monitoring devices for electrical parameters
61000-4-30	Electromagnetic compatibility (EMC) – Power quality measurements methods.
61000-4-7 + A1	Electromagnetic compatibility (EMC) – General guide on harmonics and inter-harmonics measurements.
61000-4-15	Electromagnetic compatibility (EMC) – Flicker meter.
50160	Voltage characteristics of electricity supplied by public distribution networks.
62053-22	Electricity metering equipment - Static meters for active energy (classes 0.2 S and 0.5 S.)
62053-24	Electricity metering equipment - Static meters for reactive energy (class 0.5 S).
62053-31	Electricity metering equipment Particular requirements - Part 31: Pulse output devices for electromechanical and electronic meters (two wires only).
61326-1	EMC requirements for electrical equipment for measurement, control and laboratory use.
60529/A1	Degrees of protection provided by enclosures (IP code).
60068-2-1/-2/-6/-27/-30	Environmental testing (-1 Cold, -2 Dry heat, -30 Damp heat, -6 Vibration, -27 Shock).
UL 94	Tests for flammability of plastic materials for parts in devices and appliances.
IEEE 1159-3	Recommended Practice for the Transfer of Power Quality Data (PQDIF).
IEEE C37.111	Standard Common format for transient Data Exchange (COMTRADE) for Power Systems.

Table 1: List of applicable standards

VOLTAGE QUALITY

Voltage Quality is a well-defined term (sometimes also termed Power Quality – PQ) and is covered with a selection of parameters, each of which represents certain phenomenon. They represent only most common types of phenomena, which can describe operation of electrical network with closest approximation.

Power Quality Analyzer iMC784A measures, detects, stores and evaluates parameters, which are defined in several standards. Evaluation is by default performed according to limits set in European standard EN50160. Beside that, users can always alter parameters according to their own requirements or according to immunity of their equipment which operates within the analyzed power network.

PQ recording settings

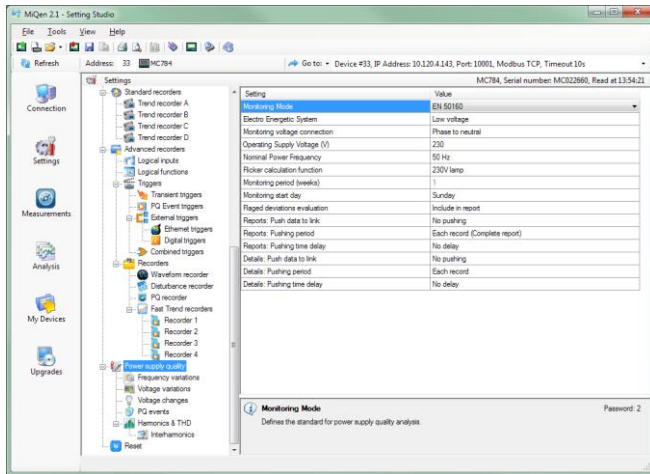

Figure 1: Settings for power quality report parameters as seen with MiQEN setting studio SW

Characteristic parameters that describe power quality are shown below:

Phenomena	PQ Parameters
Frequency variations	Frequency variations
Voltage variations	Voltage variations Voltage unbalance
Voltage changes	Rapid voltage changes Flicker
Voltage events	Voltage dips Voltage interruptions Voltage swells Short interruptions Long interruptions
Harmonics & THD	Harmonics THD's Signaling voltage

Table 2: Voltage quality parameters as defined in EN50160

PQ reports and PQ event triggers

PQ reports are issued on a basis of chosen PQ parameters as well as generation period (normally weekly) and type of network. Each report record is internally stored for later analysis together with all related anomalies and PQ records, which are generated, based on a PQ event triggering mechanism. The MiQEN setting software allows the user to quickly view PQ reports with limit lines and compliance results as well as to analyse anomalies. During the time when certain parameters are outside limit lines it is possible to view (synchronized) time stamped anomalies, together with corresponding PQ event triggered records. With all that information the user can establish the true origin of the anomaly and determine its' consequences to the network.

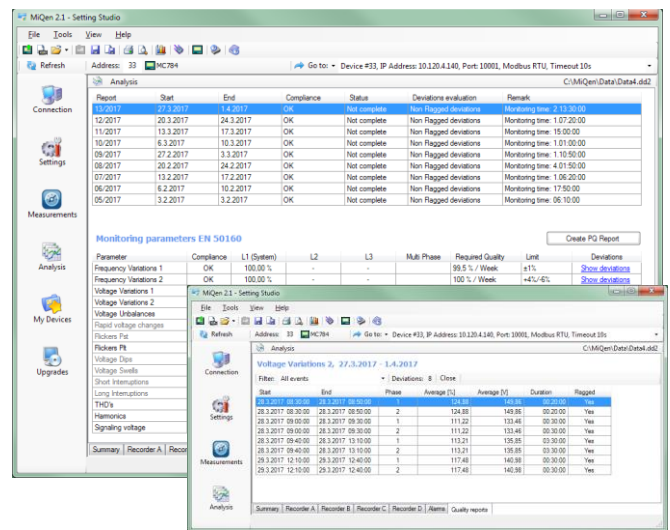

Figure 2: Viewing power quality report parameters and anomalies with MiQEN

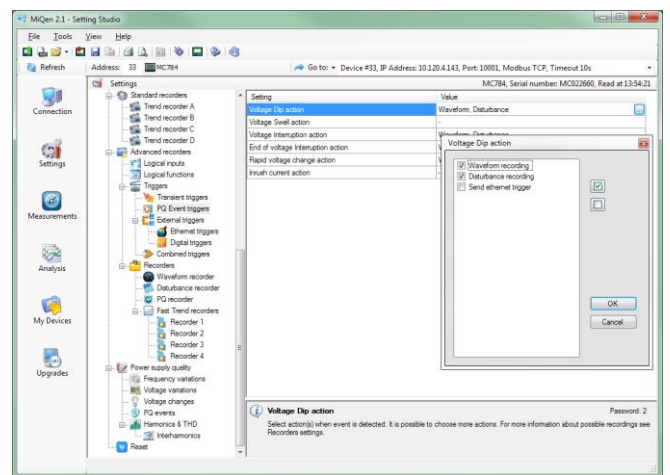

Figure 3: PQ event trigger settings in MiQEN

MEASUREMENTS

Online measurements

Online measurements are available through the display or can be monitored with the *MiQEN SW*.

For better overview over numerous readings, measurements are divided into several groups, which contain basic measurements, min. and max. values, harmonics, PQ data and alarms.

Each group can represent data in visually favored graphical form or as a detailed table form. The latter allows freezing readings and/or copying data into various report generation software tools.

Interactive instrument

A useful MiQEN SW communication feature allows interactive operation with a dislocated device as if it would be operational in front of the user.

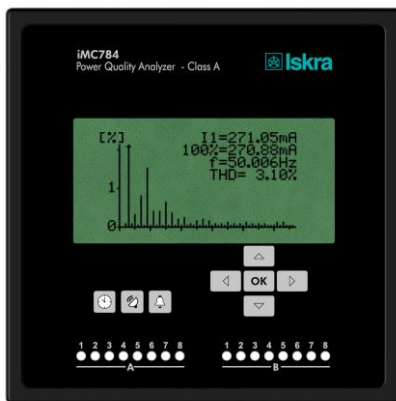

Selection of available quantities

Available online measuring quantities and their appearance can vary according to the preset power network type and other settings such as; average interval, max. demand mode, reactive power calculation method ...

Complete selection of available online measuring quantities is shown in a table on the next page.

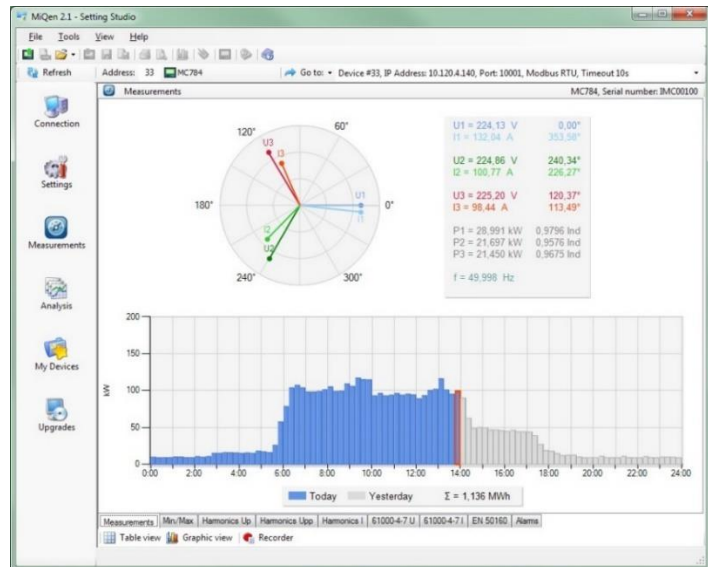

Figure 4: Online measurements in graphical form – phasor diagram and daily 24 hour total active power consumption histogram

Measurements	L1	L2	L3	Total	Others
Voltage	225.27 V	225.27 V	225.27 V	34.23 A	U* = 225.27 V
Current	21.39 A	8.558 A	4.279 A	3.152 kW	I* = 11.41 A
Real Power	1.965 kW	788.3 W	394.6 W	7.036 kvar	
Reactive Power	-4.398 kvar	-1.759.2 var	-879.5 var	7.710 kVA	
Apparent Power	4.818 kVA	1.527.8 VA	953.9 VA	0.4088 Cap	
Power Factor	0.4088 Cap	0.4089 Cap	0.4093 Cap	0.72 %	
Power Angle	-12.41 °	-12.55 °	-12.63 °	0.72 %	
Displacement Power Factor	0.9767 Cap	0.9761 Cap	0.9758 Cap	0.72 %	
THD-Up	0.72 %	0.72 %	0.72 %	214.46 %	
THD-I	215.16 %	214.79 %	214.46 %	0.77 %	
TDD-I	3.87 %	1.55 %	0.77 %	-0.703 kvar	
Fundamental Reactive Power Qfund	-5.440 kvar	-178.4 var	-89.9 var	7.002 kvar	
Deformed Power D	4.377 kvar	1.750.6 var	874.9 var	95.61	
Kfactor	95.71	95.61	95.61	418.5 %	
Current Crest factor	418.5 %	418.5 %	418.5 %	0.01 V	
DC Voltage	0.01 V	0.01 V	0.01 V	34.228 A	
Neutral line	Measured	Angle	Calculated	Error	DC
Current	0.000 A	0.00 °	34.228 A	-0.03 V	
Voltage	140.03 V	-162.73 °			
Energy counters	Counter E1 (Imp)	Counter E2 (Imp)	Counter E3 (Imp)	Counter E4 (Imp)	Active tariff
Total	383.850 kWh	124.363 kWh	703.435 kWh	2.451.707 kWh	2
Tarif 1	383.850 kWh	253.222 kWh	154.888 kWh	2.451.706 kWh	

Figure 5: A complete list of online measurements in table form

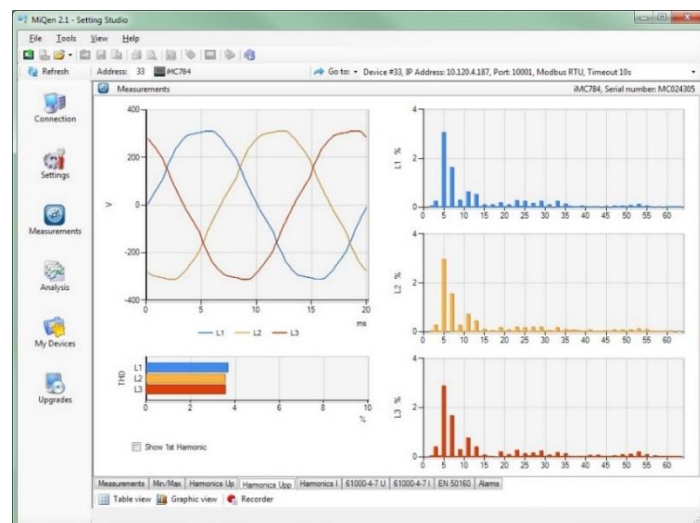

















Figure 6: Online harmonics (phase voltage, phase-phase voltage, intra-phase, current/voltage THDs and current harmonics) in graphic form

Meas. type	Measurement	3-phase 4-wire	3-phase 3-wire	1-phase	comments
Phase measurements	Voltage				
	U _{1-3_TRMS}	<input checked="" type="checkbox"/>		<input checked="" type="checkbox"/> 1ph	
	U _{AVG_TRMS}	<input checked="" type="checkbox"/>		<input checked="" type="checkbox"/>	
	U _{unbalance_neg_TRMS}	<input checked="" type="checkbox"/>	<input checked="" type="checkbox"/>		
	U _{unbalance_zero_TRMS}	<input checked="" type="checkbox"/>	<input checked="" type="checkbox"/>		
	U _{1-3_DC}	<input checked="" type="checkbox"/>		<input checked="" type="checkbox"/> 1ph	DC component of phase voltages
	U _{0_Zero_sequence_TRMS}	<input checked="" type="checkbox"/>	<input checked="" type="checkbox"/>		Zero sequence voltage
	U _{1_Positive_sequence_TRMS}	<input checked="" type="checkbox"/>	<input checked="" type="checkbox"/>		Positive sequence voltage
	U _{2_Negative_sequence_TRMS}	<input checked="" type="checkbox"/>	<input checked="" type="checkbox"/>		Negative sequence voltage
	Current				
	I _{1-3_TRMS}	<input checked="" type="checkbox"/>	<input checked="" type="checkbox"/>	<input checked="" type="checkbox"/> 1ph	
	I _{TOT_TRMS}	<input checked="" type="checkbox"/>	<input checked="" type="checkbox"/>	<input checked="" type="checkbox"/>	
	I _{AVG_TRMS}	<input checked="" type="checkbox"/>	<input checked="" type="checkbox"/>	<input checked="" type="checkbox"/>	
	I _{unbalance_TRMS}	<input checked="" type="checkbox"/>	<input checked="" type="checkbox"/>		
	I _{unbalance_zero_TRMS}	<input checked="" type="checkbox"/>	<input checked="" type="checkbox"/>		
	I _{0_Zero_sequence_TRMS}	<input checked="" type="checkbox"/>	<input checked="" type="checkbox"/>		Zero sequence current
	I _{1_Positive_sequence_TRMS}	<input checked="" type="checkbox"/>	<input checked="" type="checkbox"/>		Positive sequence current
	I _{2_Negative_sequence_TRMS}	<input checked="" type="checkbox"/>	<input checked="" type="checkbox"/>		Negative sequence current
	Power				
	P _{1-3_TRMS}	<input checked="" type="checkbox"/>		<input checked="" type="checkbox"/> 1ph	
	P _{TOT_TRMS}	<input checked="" type="checkbox"/>	<input checked="" type="checkbox"/>	<input checked="" type="checkbox"/>	
	Q _{1-3_TRMS}	<input checked="" type="checkbox"/>		<input checked="" type="checkbox"/> 1ph	Reactive power can be calculated as a squared difference between S and P or as sample delayed
Q _{TOT_TRMS}	<input checked="" type="checkbox"/>	<input checked="" type="checkbox"/>	<input checked="" type="checkbox"/>		
Q _{b1-3_TRMS}	<input checked="" type="checkbox"/>		<input checked="" type="checkbox"/> 1ph	Budeanu reactive power Phase	
Q _{bTOT_TRMS}	<input checked="" type="checkbox"/>	<input checked="" type="checkbox"/>	<input checked="" type="checkbox"/>	Budeanu reactive power Total	
S _{1-3_TRMS}	<input checked="" type="checkbox"/>		<input checked="" type="checkbox"/> 1ph		
S _{TOT_TRMS}	<input checked="" type="checkbox"/>	<input checked="" type="checkbox"/>	<input checked="" type="checkbox"/>		
D _{1-3_TRMS}	<input checked="" type="checkbox"/>		<input checked="" type="checkbox"/> 1ph	Deformed power Phase	
D _{TOT_TRMS}	<input checked="" type="checkbox"/>	<input checked="" type="checkbox"/>	<input checked="" type="checkbox"/>	Deformed power Total	
PF _{1-3_TRMS}	<input checked="" type="checkbox"/>		<input checked="" type="checkbox"/> 1ph		
PF _{TOT}	<input checked="" type="checkbox"/>	<input checked="" type="checkbox"/>			
dPF _{1-3_TRMS}	<input checked="" type="checkbox"/>		<input checked="" type="checkbox"/>	Displacement Power Factor Phase	
dPF _{TOT_TRMS}	<input checked="" type="checkbox"/>	<input checked="" type="checkbox"/>	<input checked="" type="checkbox"/> 1ph	Displacement Power Factor Total	
φ _{1-3_TRMS}	<input checked="" type="checkbox"/>		<input checked="" type="checkbox"/> 1ph		
Harmonic analysis					
THD-U ₁₋₃	<input checked="" type="checkbox"/>		<input checked="" type="checkbox"/> 1ph		
THD-I ₁₋₃	<input checked="" type="checkbox"/>	<input checked="" type="checkbox"/>	<input checked="" type="checkbox"/> 1ph		
TDD-I ₁₋₃	<input checked="" type="checkbox"/>	<input checked="" type="checkbox"/>	<input checked="" type="checkbox"/> 1ph		
U _{1-3_harmonic_1-63_%}	<input checked="" type="checkbox"/>		<input checked="" type="checkbox"/> 1ph	% of TRMS or % of base	
U _{1-3_harmonic_1-63_ABS}	<input checked="" type="checkbox"/>		<input checked="" type="checkbox"/> 1ph		
U _{1-3_harmonic_1-63_φ}	<input checked="" type="checkbox"/>		<input checked="" type="checkbox"/> 1ph	Monitoring up to 10 different fixed frequencies	
U _{1-3_inter-harmonic_%}	<input checked="" type="checkbox"/>		<input checked="" type="checkbox"/> 1ph		
U _{1-3_inter-harmonic_ABS}	<input checked="" type="checkbox"/>		<input checked="" type="checkbox"/> 1ph		
U _{1-3_inter-harmonic_1-63_%}	<input checked="" type="checkbox"/>		<input checked="" type="checkbox"/> 1ph		
U _{1-3_inter-harmonic_1-63_ABS}	<input checked="" type="checkbox"/>		<input checked="" type="checkbox"/> 1ph	% of TRMS or % of base	
U _{1-3_signaling_%}	<input checked="" type="checkbox"/>		<input checked="" type="checkbox"/> 1ph	Monitoring of signaling (ripple) voltage of set frequency. % of TRMS or % of base	
U _{1-3_signaling_ABS}	<input checked="" type="checkbox"/>		<input checked="" type="checkbox"/> 1ph		
I _{1-3_harmonic_1-63_%}	<input checked="" type="checkbox"/>	<input checked="" type="checkbox"/>	<input checked="" type="checkbox"/> 1ph	% of TRMS or % of base	
I _{1-3_harmonic_1-63_ABS}	<input checked="" type="checkbox"/>	<input checked="" type="checkbox"/>	<input checked="" type="checkbox"/> 1ph		
I _{1-3_harmonic_1-63_φ}	<input checked="" type="checkbox"/>	<input checked="" type="checkbox"/>	<input checked="" type="checkbox"/> 1ph	Monitoring up to 10 different fixed frequencies	
I _{1-3_inter-harmonic_%}	<input checked="" type="checkbox"/>	<input checked="" type="checkbox"/>	<input checked="" type="checkbox"/> 1ph		
I _{1-3_inter-harmonic_ABS}	<input checked="" type="checkbox"/>	<input checked="" type="checkbox"/>	<input checked="" type="checkbox"/> 1ph		
I _{1-3_inter-harmonic_1-63_%}	<input checked="" type="checkbox"/>	<input checked="" type="checkbox"/>	<input checked="" type="checkbox"/> 1ph		
I _{1-3_inter-harmonic_1-63_ABS}	<input checked="" type="checkbox"/>	<input checked="" type="checkbox"/>	<input checked="" type="checkbox"/> 1ph	% of TRMS or % of base	
I _{1-3_signaling_%}	<input checked="" type="checkbox"/>		<input checked="" type="checkbox"/> 1ph	Monitoring of signaling (ripple) current of set frequency. % of TRMS or % of base	
I _{1-3_signaling_ABS}	<input checked="" type="checkbox"/>		<input checked="" type="checkbox"/> 1ph		
Flickers					
Pi ₁₋₃	<input checked="" type="checkbox"/>		<input checked="" type="checkbox"/> 1ph	Instantaneous flicker sensation measured with 150 samples / sec (original sampling is 1200 samples / sec)	
Pst ₁₋₃	<input checked="" type="checkbox"/>		<input checked="" type="checkbox"/> 1ph	10 min statistical evaluation (128 classes of CPF)	
Plt ₁₋₃	<input checked="" type="checkbox"/>		<input checked="" type="checkbox"/> 1ph	Derived from 12 Pst acc. to EN 61000-4-15	
Miscellaneous					
K-factor ₁₋₃	<input checked="" type="checkbox"/>	<input checked="" type="checkbox"/>	<input checked="" type="checkbox"/> 1ph		
Current Crest factor I ₁₋₃	<input checked="" type="checkbox"/>	<input checked="" type="checkbox"/>	<input checked="" type="checkbox"/> 1ph		
Voltage Crest factor U ₁₋₃	<input checked="" type="checkbox"/>		<input checked="" type="checkbox"/> 1ph		

Meas. type	Measurement	3-phase 4-wire	3-phase 3-wire	1-phase	comments
Phase to phase measurements	Voltage				
	U _{pp1-3_TRMS}	<input checked="" type="checkbox"/>	<input checked="" type="checkbox"/>		
	U _{ppAVG_TRMS}	<input checked="" type="checkbox"/>	<input checked="" type="checkbox"/>		
	THD-U _{pp1-3}	<input checked="" type="checkbox"/>	<input checked="" type="checkbox"/>		
	Φ _{x-y_TRMS}	<input checked="" type="checkbox"/>			Phase-to-phase angle
	U _{pp1-3_harmonic_1-63_%}	<input checked="" type="checkbox"/>	<input checked="" type="checkbox"/>		% of TRMS or % of base
	U _{pp1-3_harmonic_1-63_ABS}	<input checked="" type="checkbox"/>	<input checked="" type="checkbox"/>		
	U _{pp1-3_harmonic_1-63_φ}	<input checked="" type="checkbox"/>	<input checked="" type="checkbox"/>		
	U _{pp1-3_interharmonic_1-63_%}	<input checked="" type="checkbox"/>	<input checked="" type="checkbox"/>	<input checked="" type="checkbox"/> 1ph	% of TRMS or % of base
	U _{pp1-3_interharmonic_1-63_ABS}	<input checked="" type="checkbox"/>	<input checked="" type="checkbox"/>	<input checked="" type="checkbox"/> 1ph	
	U _{underdeviation}	<input checked="" type="checkbox"/>	<input checked="" type="checkbox"/>	<input checked="" type="checkbox"/> 1ph	U _{under.} and U _{over.} are calculated for phase or phase-to-phase voltages regarding connection mode.
	U _{overdeviation}	<input checked="" type="checkbox"/>	<input checked="" type="checkbox"/>	<input checked="" type="checkbox"/> 1ph	
	Voltage Crest factor U _{pp1-3}	<input checked="" type="checkbox"/>	<input checked="" type="checkbox"/>	<input checked="" type="checkbox"/> 1ph	
	Flickers				
Pi _{pp1-3}		<input checked="" type="checkbox"/>		Phase-to-phase flickers.	
Pst _{pp1-3}		<input checked="" type="checkbox"/>			
Plt _{pp1-3}		<input checked="" type="checkbox"/>			
Metering	Energy	<input checked="" type="checkbox"/>	<input checked="" type="checkbox"/>	<input checked="" type="checkbox"/>	
	Counter E ₁₋₈	<input checked="" type="checkbox"/>	<input checked="" type="checkbox"/>	<input checked="" type="checkbox"/>	Each counter can be dedicated to any of four quadrants (P-Q, import-export, L-C). Total energy is a sum of one counter for all tariffs. Tariffs can be fixed, date/time dependent or tariff input dependent
	E _{TOT_1-8}	<input checked="" type="checkbox"/>	<input checked="" type="checkbox"/>	<input checked="" type="checkbox"/>	
	Active tariff	<input checked="" type="checkbox"/>	<input checked="" type="checkbox"/>	<input checked="" type="checkbox"/>	
Billing	<input checked="" type="checkbox"/>	<input checked="" type="checkbox"/>	<input checked="" type="checkbox"/>		
Auxiliary Channel measurements	Aux. line				
	U _{NEUTRAL-EARTH}	<input checked="" type="checkbox"/>		<input checked="" type="checkbox"/>	Aux. voltage is dedicated for neutral-earth meas. only
	I _{NEUTRAL_meas}	<input checked="" type="checkbox"/>		<input checked="" type="checkbox"/>	Measured neutral current with 4th current input
	I _{NEUTRAL_calc}	<input checked="" type="checkbox"/>	<input checked="" type="checkbox"/>	<input checked="" type="checkbox"/>	Calculated neutral current
	I _{NEUTRAL_err}	<input checked="" type="checkbox"/>		<input checked="" type="checkbox"/>	Error neutral current (difference between measured and calculated)
Maximum demand measurements	Maximum demand				
	MD _{I1-3}	<input checked="" type="checkbox"/>	<input checked="" type="checkbox"/>	<input checked="" type="checkbox"/> 1ph	
	MD _{Pimport}	<input checked="" type="checkbox"/>	<input checked="" type="checkbox"/>	<input checked="" type="checkbox"/>	
	MD _{Pexport}	<input checked="" type="checkbox"/>	<input checked="" type="checkbox"/>	<input checked="" type="checkbox"/>	
	MD _{Qind}	<input checked="" type="checkbox"/>	<input checked="" type="checkbox"/>	<input checked="" type="checkbox"/>	
	MD _{Qcap}	<input checked="" type="checkbox"/>	<input checked="" type="checkbox"/>	<input checked="" type="checkbox"/>	
	MD _S	<input checked="" type="checkbox"/>	<input checked="" type="checkbox"/>	<input checked="" type="checkbox"/>	
Min and max measurements	Min and max				
	U _{1-3_TRMS_MIN}	<input checked="" type="checkbox"/>		<input checked="" type="checkbox"/> 1ph	
	U _{1-3_TRMS_MAX}	<input checked="" type="checkbox"/>		<input checked="" type="checkbox"/> 1ph	
	U _{0_Zero_sequence_TRMS_MIN}	<input checked="" type="checkbox"/>	<input checked="" type="checkbox"/>		Max/Min Zero sequence voltage
	U _{0_Zero_sequence_TRMS_MAX}	<input checked="" type="checkbox"/>	<input checked="" type="checkbox"/>		
	U _{1_Positive_sequence_TRMS_MIN}	<input checked="" type="checkbox"/>	<input checked="" type="checkbox"/>		Max/Min Positive sequence voltage
	U _{1_Positive_sequence_TRMS_MAX}	<input checked="" type="checkbox"/>	<input checked="" type="checkbox"/>		
	U _{2_Negative_sequence_TRMS_MIN}	<input checked="" type="checkbox"/>	<input checked="" type="checkbox"/>		Max/Min Negative sequence voltage
	U _{2_Negative_sequence_TRMS_MAX}	<input checked="" type="checkbox"/>	<input checked="" type="checkbox"/>		
	U _{pp1-3_TRMS_MIN}	<input checked="" type="checkbox"/>	<input checked="" type="checkbox"/>	<input checked="" type="checkbox"/>	
	U _{pp1-3_TRMS_MAX}	<input checked="" type="checkbox"/>	<input checked="" type="checkbox"/>	<input checked="" type="checkbox"/>	
	I _{1-3_TRMS_MIN}	<input checked="" type="checkbox"/>	<input checked="" type="checkbox"/>	<input checked="" type="checkbox"/> 1ph	
	I _{1-3_TRMS_MAX}	<input checked="" type="checkbox"/>	<input checked="" type="checkbox"/>	<input checked="" type="checkbox"/> 1ph	
	I _{NEUTRAL_meas_TRMS_MIN}	<input checked="" type="checkbox"/>	<input checked="" type="checkbox"/>	<input checked="" type="checkbox"/>	
	I _{NEUTRAL_meas_TRMS_MAX}	<input checked="" type="checkbox"/>	<input checked="" type="checkbox"/>	<input checked="" type="checkbox"/>	
	I _{0_Zero_sequence_TRMS_MIN}	<input checked="" type="checkbox"/>	<input checked="" type="checkbox"/>		Max/Min Zero sequence current
	I _{0_Zero_sequence_TRMS_MAX}	<input checked="" type="checkbox"/>	<input checked="" type="checkbox"/>		
	I _{1_Positive_sequence_TRMS_MIN}	<input checked="" type="checkbox"/>	<input checked="" type="checkbox"/>		Max/Min Positive sequence current
	I _{1_Positive_sequence_TRMS_MAX}	<input checked="" type="checkbox"/>	<input checked="" type="checkbox"/>		
I _{2_Negative_sequence_TRMS_MIN}	<input checked="" type="checkbox"/>	<input checked="" type="checkbox"/>		Max/Min Negative sequence current	
I _{2_Negative_sequence_TRMS_MAX}	<input checked="" type="checkbox"/>	<input checked="" type="checkbox"/>			

For more information see **Power Quality Analyzer iMC784A** User's manual

Meas. type	Measurement	3-phase 4-wire	3-phase 3-wire	1-phase	comments
Min and max measurements	P _{1-3_TRMS_MIN}	<input checked="" type="checkbox"/>		<input checked="" type="checkbox"/> 1ph	
	P _{1-3_TRMS_MAX}	<input checked="" type="checkbox"/>		<input checked="" type="checkbox"/> 1ph	
	P _{TOT_TRMS_MIN}	<input checked="" type="checkbox"/>	<input checked="" type="checkbox"/>	<input checked="" type="checkbox"/> 1ph	
	P _{TOT_TRMS_MAX}	<input checked="" type="checkbox"/>	<input checked="" type="checkbox"/>	<input checked="" type="checkbox"/> 1ph	
	Q _{bTOT_TRMS_MIN}	<input checked="" type="checkbox"/>	<input checked="" type="checkbox"/>		Max/Min Budeanu reactive power Total
	Q _{bTOT_TRMS_MAX}	<input checked="" type="checkbox"/>	<input checked="" type="checkbox"/>		
	Q _{b1-3_TRMS_MIN}	<input checked="" type="checkbox"/>	<input checked="" type="checkbox"/>		Max/Min Budeanu reactive power Phase
	Q _{b1-3_TRMS_MAX}	<input checked="" type="checkbox"/>	<input checked="" type="checkbox"/>		
	S _{1-3_TRMS_MIN}	<input checked="" type="checkbox"/>		<input checked="" type="checkbox"/> 1ph	
	S _{1-3_TRMS_MAX}	<input checked="" type="checkbox"/>		<input checked="" type="checkbox"/> 1ph	
	S _{TOT_TRMS_MIN}	<input checked="" type="checkbox"/>	<input checked="" type="checkbox"/>	<input checked="" type="checkbox"/> 1ph	
	S _{TOT_TRMS_MAX}	<input checked="" type="checkbox"/>	<input checked="" type="checkbox"/>	<input checked="" type="checkbox"/> 1ph	
	D _{TOT_TRMS_MIN}	<input checked="" type="checkbox"/>	<input checked="" type="checkbox"/>		Max/Min Deformed power Total
	D _{TOT_TRMS_MAX}	<input checked="" type="checkbox"/>	<input checked="" type="checkbox"/>		
	D _{1-3_TRMS_MIN}	<input checked="" type="checkbox"/>	<input checked="" type="checkbox"/>		Max/Min Deformed power Phase
	D _{1-3_TRMS_MAX}	<input checked="" type="checkbox"/>	<input checked="" type="checkbox"/>		
	dPF _{TOT_TRMS_MIN}	<input checked="" type="checkbox"/>	<input checked="" type="checkbox"/>		Max/Min Displacement Power Factor Total
	dPF _{TOT_TRMS_MAX}	<input checked="" type="checkbox"/>	<input checked="" type="checkbox"/>		
	dPF _{1-3_TRMS_MIN}	<input checked="" type="checkbox"/>	<input checked="" type="checkbox"/>		Max/Min Displacement Power Factor Phase
	dPF _{1-3_TRMS_MAX}	<input checked="" type="checkbox"/>	<input checked="" type="checkbox"/>		
freq _{MIN}	<input checked="" type="checkbox"/>	<input checked="" type="checkbox"/>	<input checked="" type="checkbox"/>		
freq _{MAX}	<input checked="" type="checkbox"/>	<input checked="" type="checkbox"/>	<input checked="" type="checkbox"/>		
Other measurements	Miscellaneous				
	Internal temp.	<input checked="" type="checkbox"/>	<input checked="" type="checkbox"/>	<input checked="" type="checkbox"/>	
	Date, Time	<input checked="" type="checkbox"/>	<input checked="" type="checkbox"/>	<input checked="" type="checkbox"/>	
	Last Sync. time	<input checked="" type="checkbox"/> 	<input checked="" type="checkbox"/> 	<input checked="" type="checkbox"/> 	UTC
	GPS Time	<input checked="" type="checkbox"/> 	<input checked="" type="checkbox"/> 	<input checked="" type="checkbox"/> 	If GPS receiver is connected to dedicated RTC time synchronization input
	GPS Longitude	<input checked="" type="checkbox"/> 	<input checked="" type="checkbox"/> 	<input checked="" type="checkbox"/> 	
	GPS Latitude	<input checked="" type="checkbox"/> 	<input checked="" type="checkbox"/> 	<input checked="" type="checkbox"/> 	
	GPS Altitude	<input checked="" type="checkbox"/> 	<input checked="" type="checkbox"/> 	<input checked="" type="checkbox"/> 	

 For more information see Power Quality Analyzer iMC784A User's manual

RECORDERS

A built-in recorder (8 GB) enables storing periodic measurements, detected alarms, PQ reports with corresponding anomalies, trigger history as well as waveforms (including transients), disturbances and PQ recorder records (reports and anomalies). It supports recording of all measured quantities including voltage and current harmonics and inter-harmonics (up to 63rd) in multiple recorders. For each recorder it is possible to setup a storage interval (for periodic trend recorders) as well as other recording parameters. Apart from periodic trend recorder, data recorders are also used to store the following data:

- Alarms where each alarm is triggered by means of a preset threshold and is stored in the form of alarm i.d. and its corresponding timestamp,
- PQ reports where each report in recorder is identified by a monitoring interval (date) – typically once per week,
- PQ report anomalies representing (synchronized) time stamped PQ values that are outside PQ limit lines,
- Trigger based recorders which store a timestamp related database of all triggers which have occurred together with (optional) PQDIF/COMTRADE related records, which are recorded, based on pre-set triggering conditions. These records can be of types: waveform, disturbance, PQ or fast trend record. The figure below shows waveform recorder settings:

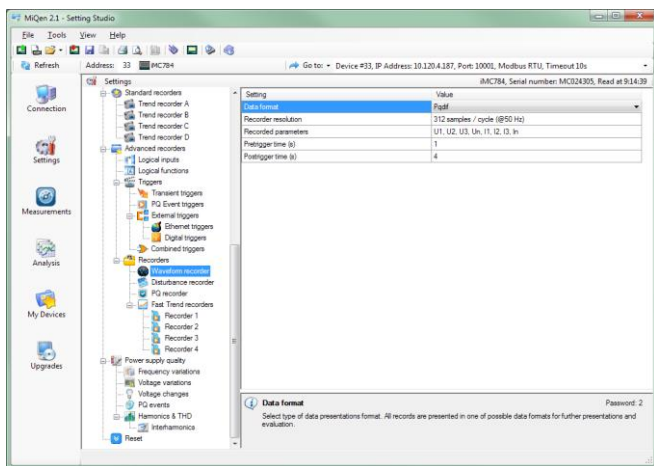

Figure 7: Setting trigger related recorders in MiQEN (example shown for waveform recorder)

The complete content of the recorder can be viewed and downloaded with MiQEN setting SW in a detailed table or visually favored graphical form.

ALARMS AND TRIGGERS

Alarms and triggers represent powerful tool for Power Quality Analyzer iMC784A control, supervision and oscillography recording features. By using alarms, the devices' performance can hence reach beyond just measuring and analyzing power network.

Power Quality Analyzer iMC784A supports recording and storing of 32 alarms in four groups. Time constant of maximal values in a thermal mode, compare time delay, hysteresis and response time are defined for each group of alarms.

For each parameter, it is possible to set a limit value, condition and alarm activation action (sound signal and/or digital output switch if available).

All alarms are also stored in internal memory for post-analysis:

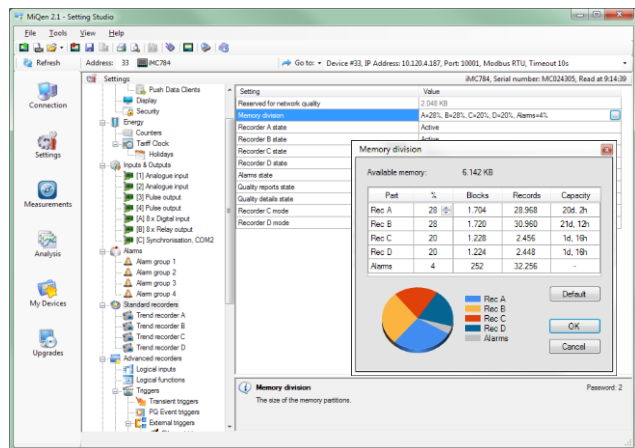

Figure 8: Setting recorder parameters and viewing memory consumption information

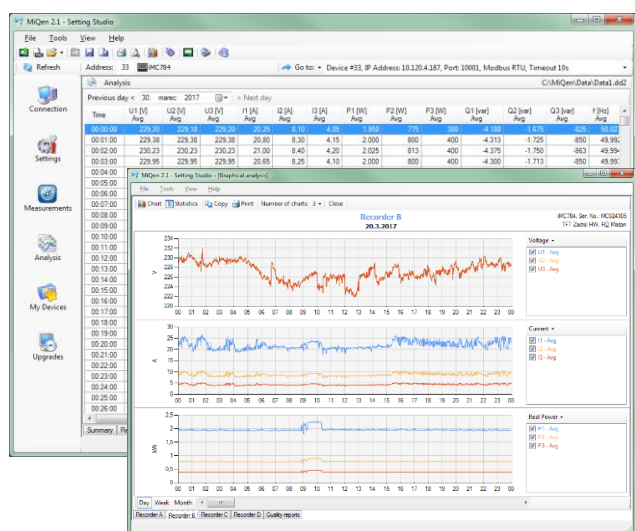

Figure 9: Viewing recorder content in table and graphical form

REAL TIME SYNCHRONISATION

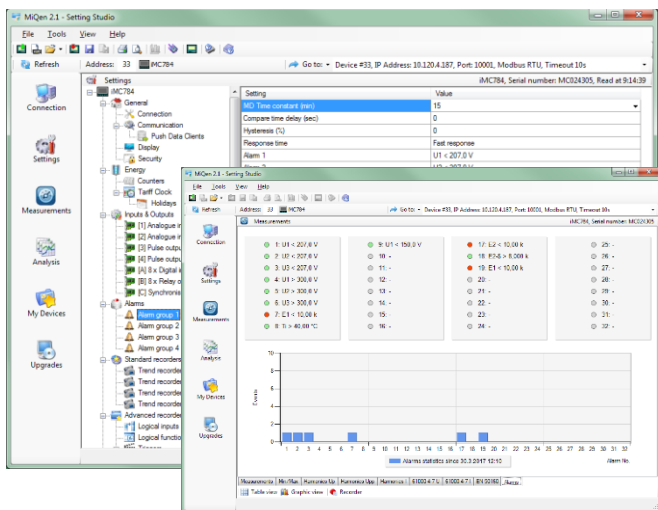

Figure 10: Setting and viewing alarms

A sophisticated triggering mechanism is used to register and record events of various natures:

- Transient event generated triggers based on hold-off time (in ms), absolute peak value (in % of U_n), fast change (in % $U_n/\mu s$),
- PQ event generated triggers based on the following events: voltage dip, voltage swell, voltage interruption, end of voltage interruption, rapid voltage change and inrush current,
- External Ethernet triggers enabling trigger events with up to 8 different dislocated devices connected within the network,
- External digital triggers based on logical/digital inputs,
- Up to 16 combined triggers enabling logical operation on previously configured triggers of various natures.

An example of transient trigger settings in MiQEN SW is shown below:

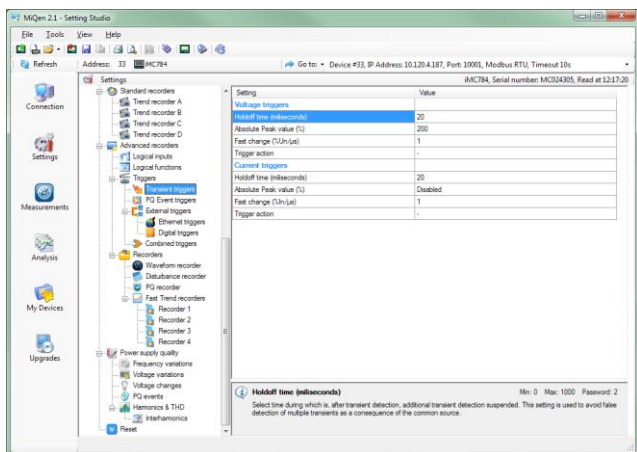

Figure 11: Setting trigger in MiQEN (example shown for transient trigger)

Synchronized real-time clock (RTC) is an essential part of any Class A analyzer for proper chronological determination of various events. Without RTC synchronization, Power Quality Analyzer iMC784A acts as a Class S device.

To distinct cause from consequence, to follow a certain event from its origin to manifestation in other parameters it is very important that each and every event and recorded measurement on one instrument can be compared with events and measurements on other devices. Even if instruments are dislocated, which is normally the case in electro distribution and transmission network events have to be time-comparable with accuracy better than a single period.

For this purpose, instruments normally support highly accurate internal RTC. Still this is not enough, since temperature is location dependent and it influences its precision. For that reason, it is required to implement periodical RTC synchronization.

Power Quality Analyzer iMC784A supports three types of RTC synchronization.

GPS time synchronization:

1pps and serial RS232 communication with NMEA 0183 sentence support.

GPS interface is designed as 5 pole pluggable terminal (+5V for receiver supply, 1pps input and standard RS232 communication interface).

Proposed GPS receiver is MEINBERG GPS164 or similar.

IRIG time code B (IRIG-B):

Unmodulated (DC 5V level shift) and modulated (1 kHz) serial coded format with support for 1pps, day of year, current year and straight seconds of day as described in standard IRIG-200-04. Supported serial time code formats are IRIG-B007 and IRIG-B127

Interface for modulated IRIG-B is designed as BNC-F terminal with 600 Ohm input impedance. Interface for unmodulated IRIG-B is designed as pluggable terminal.

Network time protocol (NTP):

Synchronization via Ethernet requires access to a NTP server.

Note: NTP can usually maintain time to within tens of milliseconds over the public Internet, but the accuracy depends on infrastructure properties - asymmetry in outgoing and incoming communication delay affects systematic bias. It is recommended that dedicated network rather than public network is used for synchronization purposes.

COMMUNICATION

Power Quality Analyzer iMC784A has a wide variety of communication possibilities to suit specific demands. It is equipped with standard communication port COM1 and auxiliary communication port COM2. This allows two different users to access data from a device simultaneously and by using TCP/IP communication, data can be accessed worldwide.

Configuration	COM1	COM2
	Ethernet & USB ⁽¹⁾	RS232/RS485 ⁽²⁾

⁽¹⁾ Galvanic separation between Eth. and USB is 1 kV_{ACRMS}. USB can be used as service port.

⁽²⁾ RS232/RS485 communication and GPS time synchronization cannot be used at the same time. When GPS time synchronization is used, RS232/RS485 communication on COM2 is not available.

Table 4: Communication configuration

Power Quality Analyzer iMC784A supports standard communication protocols MODBUS RTU, MODBUS TCP, DNP3 L1, MQTT, upgradeable to IEC61850 Ed.2 (optionally).

Additionally it supports the proprietary *PUSH or MQTT (M2M) communication mode*, which is used in system applications with multiple devices attached into the network.

TECHNICAL DATA

Measurement inputs

Frequency measurements:

Nominal frequency range 50 Hz, 60 Hz
 Measuring frequency range 16 Hz – 400 Hz

Voltage measurements:

Number of channels 4 ⁽¹⁾
 Nominal value (U_N) 500 V_{LN}, 866 V_{LL}
 Min. voltage for sync. From starting voltage for SYNC (min value - 1 V_{rms})
 Min, measured value From starting voltage for all powers
 Max. measured value (cont.) 600 V_{LN}; 1000 V_{LL}
 Max. allowed value $1.2 \times U_N$ permanently
 $2 \times U_N$; 10 s
 Consumption $< U^2 / 4.2 \text{ M}\Omega$ per phase
 Input impedance 4.2 M Ω per phase

⁽¹⁾ 4th channel is used for measuring $U_{\text{EARTH-NEUTRAL}}$

Current measurements:

Number of channels 4
 Nominal value (I_{NOM}) 1 A, 5 A
 Min. measured value From starting current for all powers
 Max. measured value 12.5 A sinusoidal (I_1 - I_3 only)
 Max. allowed value (thermal) 15 A continuous $\leq 300 \text{ A}$; 1 s
 Consumption $< I^2 \times 0.01 \Omega$ per phase

Sampling and resolution:

Waveform sampling 32 μs (625 Samples per Cycle)
 ADC resolution 24 bit 8-ch simultaneous inputs
 Reading refresh rate 100 ms – 5 s (User defined)
 Timestamp resolution 1 ms

System:

Voltage inputs can be connected either directly to low-voltage network or via a voltage transformer to a higher voltage network.

Current inputs can be connected either directly to low-voltage network or shall be connected to network via a corresponding current transformer (with standard 1 A or 5 A outputs).

Basic accuracy under reference conditions

Accuracy is presented as percentage of reading of the measured value except when it is stated as an absolute value.

Measurand	Accuracy	
Voltage L-N, L-L	$\pm 0.1 \%$	acc. to EN 61557-12
Current	$\pm 0.1 \%$	acc. to EN 61557-12
Active power ($I_N = 5\text{A}$)	$\pm 0.2 \%$	acc. to EN 61557-12
Active power ($I_N = 1\text{A}$)	$\pm 0.5 \%$	acc. to EN 61557-12
Active energy	Cl. 0.2S	acc. to EN 62053-22
Reactive energy	Cl. 0.5S	acc. to EN 62053-24
Frequency (f)	$\pm 0.01 \text{ Hz}$	acc. to EN 61557-12
Power factor (PF)	$\pm 0.5 \%$	acc. to EN 61557-12
THD (U)	$\pm 0.3 \%$	acc. to EN 61557-12
THD (I)	$\pm 0.3 \%$	acc. to EN 61557-12
Real time clock (RTC)	$< \pm 1 \text{ s / day}$	acc. to IEC61000-4-30

All values required for PQ analysis, which should be measured according to IEC61000-4-30 correspond to Class A accuracy.

For complete overview of accuracy for all measured parameters and measuring ranges, see Users' manual.

INPUT/OUTPUT modules

Power Quality Analyzer iMC784A is equipped with two main I/O modules A and B, two auxiliary I/O modules 1/2 and 3/4 and special time-synchronization module C. The following I/O modules are available:

Module type	Number of modules per slot	
	Main slot	Aux slot
Analogue output (AO)	2	/
Analogue input (AI)	2	/
Pulse output (PO)	2	/
Pulse input (PI)	2	/
Tariff input (TI)	2	/
Relay output (RO)	2	8
Digital input (DI)	2	8
Bistable alarm output (BO)	1	/
Watchdog / Relay output	WO/RO	/

Table 5: List of available I/O modules

Analogue input (AI):

Three types of analogue inputs are suitable for acquisition of low voltage DC signals from different sensors. According to application requirements it is possible to choose current, voltage or resistance (temperature) analogue input. They all use the same output terminals.

MiQen software allows setting an appropriate calculation factor, exponent and required unit for representation of primary measured value (temperature, pressure, wind speed ...).

Analogue DC current input:

Nominal input range	- 20 ... 0 ... 20 mA ($\pm 20\%$)
Input resistance	20 Ω
Accuracy	0.5 % of range
Temperature drift	0.01 % / $^{\circ}\text{C}$
Conversion resolution	16 bit (σ -delta)
Analogue input mode	internally referenced Single-ended

Analogue DC voltage input:

Nominal input range	- 10 ... 0 ... 10 V ($\pm 20\%$)
Input resistance	100 k Ω
Accuracy	0.5 % of range
Temperature drift	0.01 % / $^{\circ}\text{C}$
Conversion resolution	16 bit (σ -delta)
Analogue input mode	internally referenced Single-ended

Analogue resistance (temperature) input:

Nominal input range (low)*	0 ... 200 Ω (max. 400 Ω) PT100 (- 200 $^{\circ}\text{C}$... 850 $^{\circ}\text{C}$)
Nominal input range (high)*	0 ... 2 k Ω (max. 4 k Ω) PT1000 (- 200 $^{\circ}\text{C}$... 850 $^{\circ}\text{C}$)
Connection	2 - wire
Accuracy	0.5 % of range
Conversion resolution	16 bit (σ -delta)
Analogue input mode	internally referenced Single-ended

* Low or high input range and primary input value (resistance or temperature) are set by the MiQen setting software

Analogue output (AO):

Output range	0 ... 20 mA
Accuracy	0.5 % of range
Max. burden	150 Ω
Linearization	Linear, Quadratic
No. of break points	6
Output value limits	$\pm 120\%$ of nominal output
Response time (measurement and analogue output)	depends on set general average interval (0.1 s – 5 s)
Residual ripple	< 1 % p.p.

Outputs may be either short or open-circuited. They are electrically insulated from each other and from all other circuits.

Output range values can be altered subsequently (zoom scale) using the setting software, but a supplementary error results.

Tariff input (TI)

Rated voltage	5 ... 48 V DC 110 $\pm 20\%$ V AC/DC 230 $\pm 20\%$ V AC/DC
Frequency range	45 ... 65 Hz

Pulse input (PI)

Rated voltage	5 ... 48 V DC
Max. Current	8 mA (at 48 V DC) + 20 %
Min. pulse width	0.5 ms
Min. pulse period	2 ms
SET voltage	40 ... 120 % of rated voltage
RESET voltage	0 ... 10 % of rated voltage

Digital input (DI)

Rated voltage	5 ... 48 V DC 110 $\pm 20\%$ V AC/DC 230 $\pm 20\%$ V AC/DC
Frequency range	45 ... 65 Hz

Bistable alarm output (BO)

Type	Relay switch
Purpose	Alarm output
Rated voltage	230 V _{AC/DC} $\pm 20\%$ max
Max. switching current	1000 mA (main slot)
Contact resistance	$\leq 100\ \text{m}\Omega$ (100 mA, 24 V)

Watchdog (WO)/Relay output (RO)

Type	Relay switch
Normal operation	Relay in ON position
Failure detection delay	$\approx 1.5\ \text{s}$
Rated voltage	230 V _{AC/DC} $\pm 20\%$ max
Max. switching current	1000 mA
Contact resistance	$\leq 100\ \text{m}\Omega$ (100 mA, 24 V)

Pulse output (PO)

Type	Optocoupler open collector switch
Purpose	Pulse output
Rated voltage	40 V _{AC/DC}
Max. switching current	30 mA ($R_{ONmax} = 8\ \Omega$)
Pulse length	programmable (2 ... 999 ms)

Time synchronization input

Digital input	GPS or IRIG-B TTL
1pps voltage level	TTL level (+ 5 V)
Time code telegram	RS232 (GPS) DC level shift (IRIG-B)
AM analogue input	IRIG-B AM modulated
Carrier frequency	1 kHz
Input impedance	600 Ohms
Amplitude	2.5 V _{P-Pmin} , 8 V _{P-Pmax}
Modulation ration	3:1 – 6:1

Auxiliary Power Supply

Measurement category	CAT III 300 V
Nominal voltage AC	100 V – 240 V; -20%...+15%
Nominal frequency	40 ... 65 Hz
Nominal voltage DC	100 V - 250 V; $\pm 20\%$
Consumption (typical)	< 8 VA typical
Consumption (max. all I/O)	< 12 VA (pixel display iMC784A) < 13 VA (TFT display iMC784A)
Power-on transient current	< 20 A; 1 ms

Safety:

Protection:	protection class II functional earth terminal must be connected to earth potential! Voltage inputs via high impedance Double insulation for I/O ports and COM ports
	
Pollution degree	2
Installation category	CAT III ; 600 V
Measuring inputs	CAT IV ; 300 V Acc. to EN 61010-1

Mechanical

Dimensions	144 × 144 × 100 mm
Mounting	Panel mounting 144 × 144 mm
Required mounting hole	138 × 138 mm
Enclosure material	PC / ABS
Flammability	Acc. to UL 94 V-0
Weight	550 g
Enclosure material	PC / ABS Acc. to UL 94 V-0

Ambient conditions:

Ambient temperature	K55 temperature class Acc. to EN61557-12 - 10 ... 55 °C
Storage temperature	- 40 to + 70 °C
Average annual humidity	≤ 90 % r.h. (no condensation)
Pollution degree	2
Enclosure protection	IP 40 (front plate) IP 20 (rear side)
Installation altitude	≤ 2000 m

Real time clock

A built-in real time clock is also without external synchronization very stable when device is connected to auxiliary power supply. For handling shorter power interruptions without influence on RTC, device uses high capacity capacitor. It ensures auxiliary supply (for internal RTC only) for more than two days of operation.

Type	Low power embedded RTC
RTC stability	< 1 sec / day

Connection cables

Power Quality Analyzer iMC784A is equipped with European style pluggable terminals for measuring voltages, auxiliary supply, communication and I/O modules. Measuring current cables shall be attached as through-hole connection without screwing.

NOTE!

Stranded wire must be used with insulated end sleeve to assure firm connection.

Voltage inputs (4)	≤ 2.5 mm ² , AWG 24-12 single wire
Current inputs (3)	≤ Ø 6 mm one conductor with insulation
Current inputs – neutral (1)	≤ Ø 5 mm one conductor with insulation
Supply (2)	≤ 2.5 mm ² , AWG 24-12 single wire
I/O (31)	≤ 2.5 mm ² , AWG 24-12 single wire ≤ 2.5 mm ² , AWG 24-12 single wire

MiQen - setting studio Software

MiQen software is intended for configuration and data analysis of a PC or network connected Power Quality Analyzer iMC784A. Network and the device setting, display of measured and stored values and analysis of stored data in the device are possible via the serial, Ethernet or USB communication. The information and stored measurements can be exported in standard .scv formats as well as into the MiSMART database and PQDIF format. The software is multilingual and runs on all Windows operating systems since Windows XP.

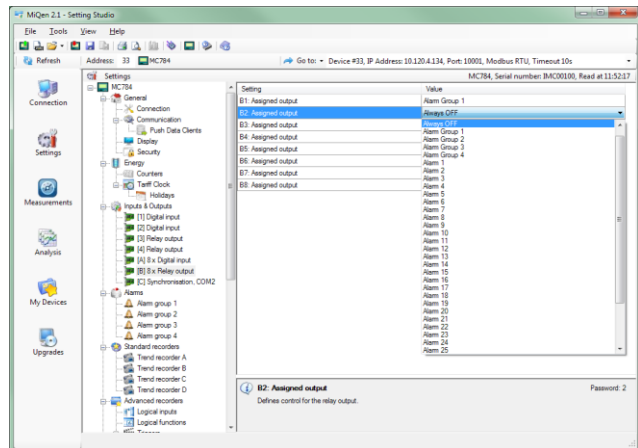
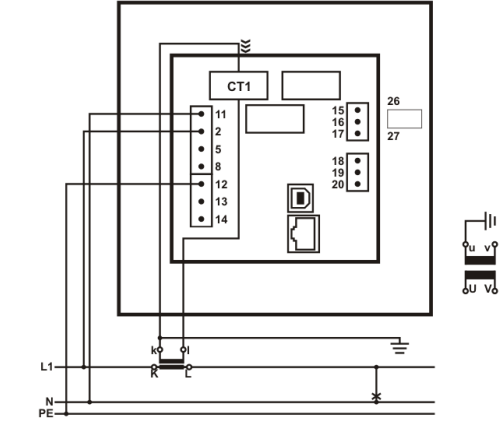
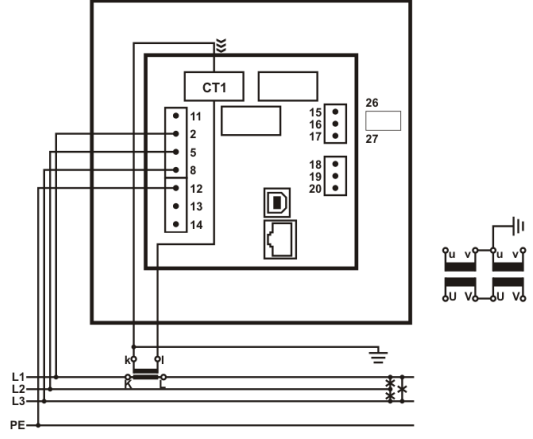
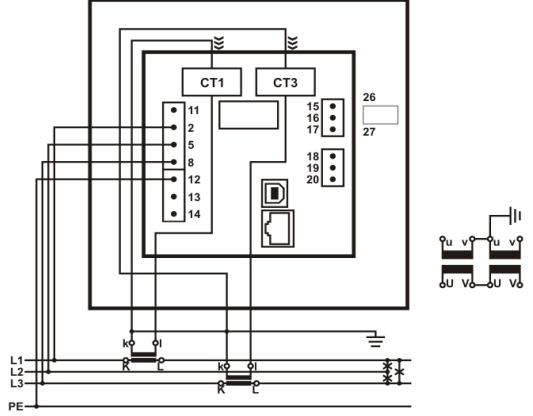

Figure 12: MiQen setting and acquisition software (relay output settings)

MiQen software is intended for the following use:

- Setting all of the instruments parameters (online and offline).
- Viewing current measured readings and stored data.
- Setting and resetting energy counters.
- Complete I/O modules configuration.
- Evaluation of the electricity supply quality in compliance with EN50160 and automatic PQ report generation.
- Viewing and exporting time-stamped PQ anomaly details.
- Upgrading instruments firmware.
- Searching the net for devices.
- Virtual interactive instrument.
- Downloading all recorded data from one selected device.
- Comprehensive help support.

CONNECTION

System/connection	Terminal assignment
<p>Connection 1b (1W1b) Single phase connection</p>	
<p>Connection 3b (1W3b) Three phase, three wire connection with balanced load</p>	
<p>Connection 3u (2W3u) Three phase, three wire connection with unbalanced load</p>	

System/connection

Connection 4b (1W4b)
 Three phase, four wire connection with balanced load

Terminal assignment

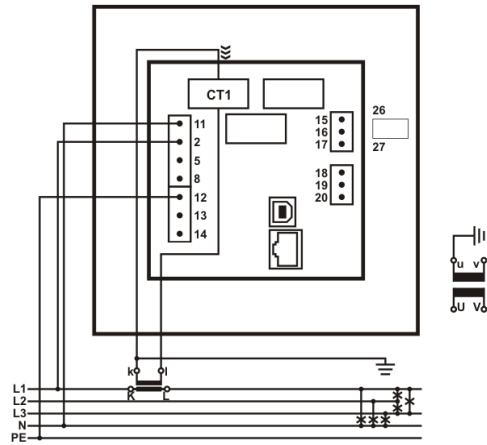

Connection 4u (3W4)
 Three phase, four wire connection with unbalanced load
 With this connection, a neutral current can be measured with 4th current sensor

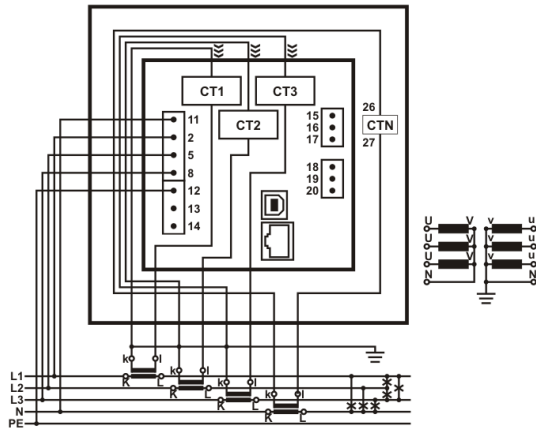

NOTE:

Terminal 12 (PE) must ALWAYS be connected regardless of system connection.

Fourth voltage channel is dedicated for measuring voltage between EARTH (PE, terminal 12) and NEUTRAL (N, terminal 11).

DIMENSIONAL DRAWING

Dimensions

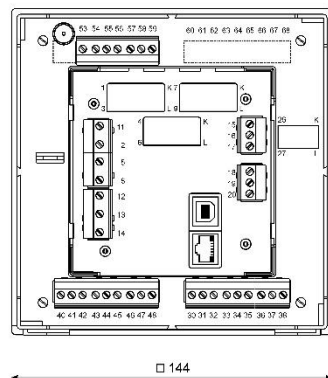
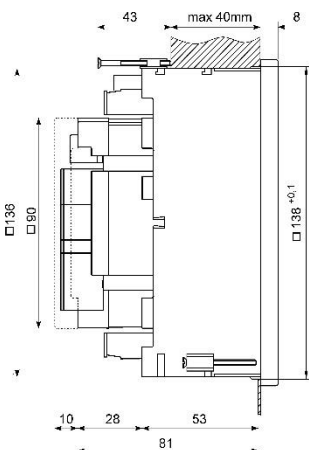

Panel cut-out

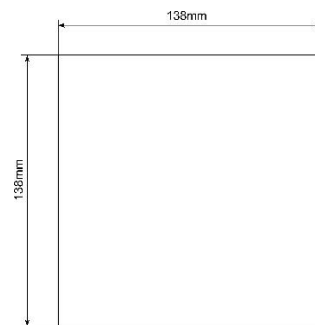

Connection table

Function		Terminals	Comment	
Measuring input	AC current	IL1	1/3	
		IL2	4/6	
		IL3	7/9	
		ILN	26/27	
	AC voltage	UL1	2	
		UL2	5	
		UL3	8	
		UN	11	
Inputs / outputs	I/O module 1/2	+ / ⚡	15	
		- / ⚡ (common)	16	
		+ / ⚡	17	
	I/O module 3/4	+ / ⚡	18	
		- / ⚡ (common)	19	
		+ / ⚡	20	
	I/O module A	- / ⚡ (common)	30	
		+ / ⚡	31 - 38	
	I/O module B	- / ⚡ (common)	40	
		+ / ⚡	41 - 48	
	I/O module C	Ⓞ BNC input	BNC	IRIG-B modulated (1kHz) time sync. signal
		1 pps	53	TTL level 1 pps time sync. Signal or IRIG-B digital
		RS485	54, 55	A – 54, B – 55
		MODEM/RS232	56-59	Rx – 56, GND – 57, Tx – 58, +5V - 59
Auxiliary power supply	+ / ⚡ (L)	13	⚡ CAT III 300V ⚡ GROUND terminal must always be connected!!	
	- / ⚡ (N)	14		
	⚡	12		
Communication	USB	Type B	USB 2.0 type B	
	ETHERNET	RJ-45	10/100 BASE-TX Ethernet	

Table 6: Connections

DATA FOR ORDERING

When ordering Power Quality Analyzer iMC784A, all required specifications shall be stated in compliance with the ordering code. Additional information could be stated. Note that fixed or programmable specifications are not part of ordering code.

Additional options:

To order the option of IEC61850 Ed.2 Server please order the following additional SW option number: 022491017000

General ordering code

The following specifications shall be stated:

Device Type	Nominal freq.	Display	Aux. power supply	Comm. COM1	I/O module 1/2	I/O module 3/4	I/O module A	I/O module B
iMC784A	X	X	H	X	X	X	X	X
							N	Without *
							M	8x Relay (alarm) output ***
							D	8x Digital input 230 V _{AC} /DC
							E	8x Digital input 110 V _{AC} /DC
							F	8x Digital input 5-48 V _{AC} /DC
					N	Without *		
					A	2x Analogue output		
					S	2x Pulse output		
					M	2x Relay (alarm) output		
					B	1x Bistable relay (alarm) output		
					W	1x Status + 1x Relay output		
					I	2x Analogue input - mA _{DC}		
					U	2x Analogue input - V _{DC}		
					R	2x Analogue input - R/Temp.		
					P	2x Pulse input 5 - 48 V _{DC}		
					D	2x Digital input 230 V _{AC} /DC		
					E	2x Digital input 110 V _{AC} /DC		
					F	2x Digital input 5 - 48 V _{AC} /DC		
					T	2x Tariff input 230 V _{AC} /DC **		
					Z	2x Tariff input 110 V _{AC} /DC **		
					Y	2x Tariff input 5 - 48 V _{AC} /DC **		
			E	E	E	Ethernet & USB *		
			S	S	S	Ethernet & USB -IEC 61850 Ed.2		
		H	H	H	H	80...300 V _{DC} , 80...276 V _{AC} *		
		T	T	T	T	5,7 inch color TFT display *		
		G	G	G	G	Graphic 128x64 pixel display		
	S	S	S	S	S	50, 60 Hz *		
	A	A	A	A	A	400 Hz		
* -						standard		
** -						I/O module 1/2 only		
*** -						I/O module A only		

Dictionary:

PQ	Power Quality alias Voltage Quality
TRMS	True Root Mean Square
PA	Power angle (between current and voltage)
PF	Power factor
VT	Voltage measuring transformer
CT	Current measuring transformer
THD	Total harmonic distortion
Ethernet	IEEE 802.3 data layer protocol
MODBUS / DNP3	Industrial protocol for data transmission
MiQen	ISKRA setting and acquisition Software
AC	Alternating quantity
RTC	Real Time Clock
IRIG	Inter-range instrumentation group time codes
NTP	Network Time Protocol

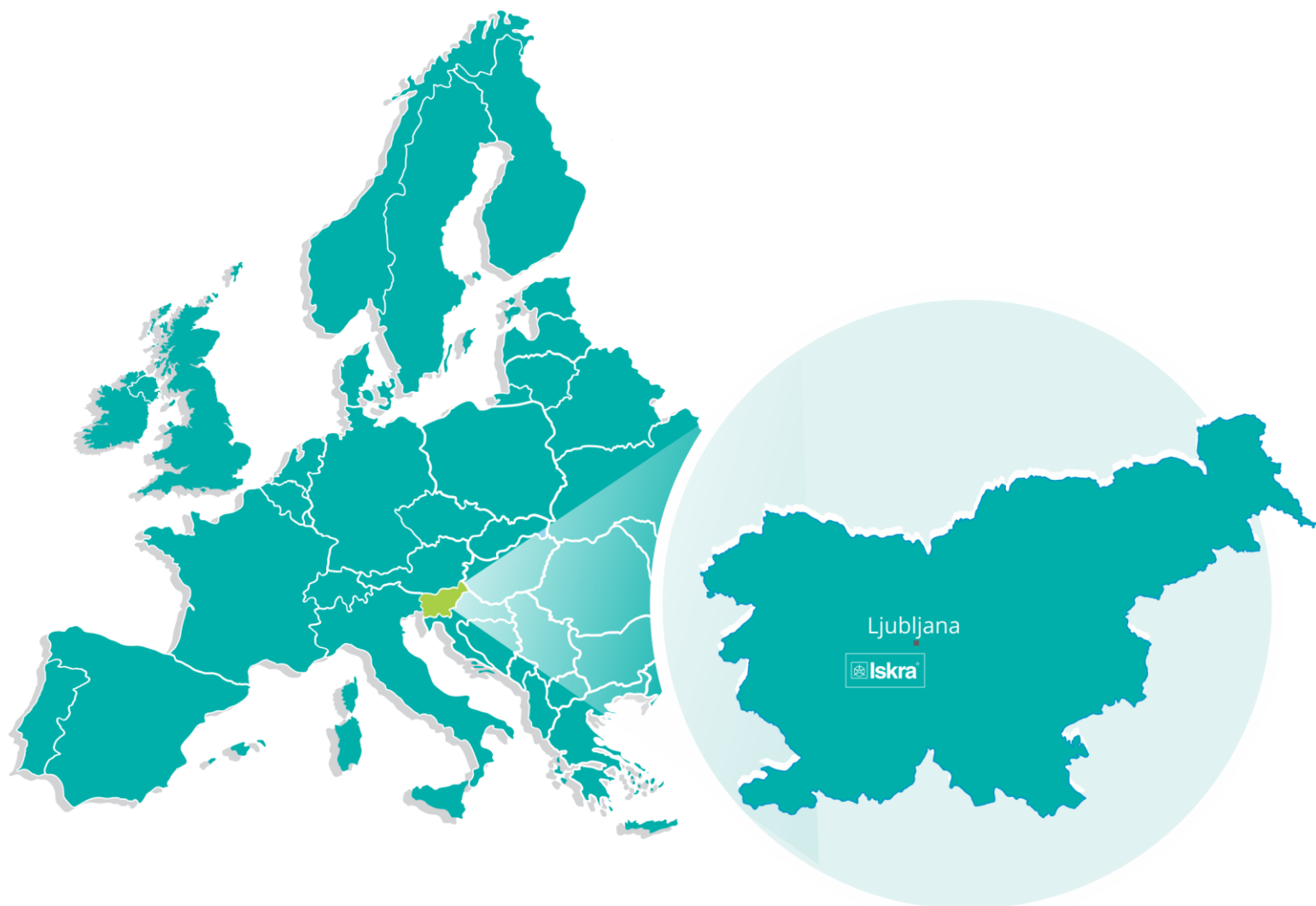

Iskra, d.o.o.
BU Ljubljana

Stegne 21
SI-1000, Ljubljana
Phone: +386 1 513 10 00

Iskra, d.o.o.
BU Capacitors

Vajdova ulica 71
SI-8333, Semič
Phone: +386 7 38 49 200

Iskra, d.o.o.
BU MIS

Ljubljanska c. 24a
SI-4000, Kranj
Phone: +386 4 237 21 12

Iskra, d.o.o.
BU Batteries & Potentiometers

Šentvid pri Stični 108
SI-1296, Šentvid pri Stični
Phone: +386 1 780 08 00

Iskra, d.o.o.
BU Electroplating

Glinek 5
SI-1291, Škofljica
Phone: +386 1 366 80 50

Iskra IP, d.o.o.

Vajdova ulica 71
SI-8333, Semič
Phone: +386 7 384 94 54

Iskra STIK, d.o.o.

Ljubljanska cesta 24a
SI-4000, Kranj
Phone: +386 4 237 22 33

Iskra Lotrič, d.o.o.

Ljubljanska c. 24a
SI-4000, Kranj
Phone: +386 4 237 21 12

Iskra ODM, d.o.o.

Ljubljanska c. 24a
SI-4000, Kranj
Phone: +386 4 237 21 12

Iskra Tela L, d.o.o.

Omladinska 66
78250, Laktaši
Phone: +387 51 535 890

Iskra Sistemi - M dooel

Ul, Dame Grujev br. 16/5 kat
1000, Skopje
Phone: +389 75 444 498

Iskra Commerce, d.o.o.

Hadži Nikole Živkoviča br. 2
11000, Beograd
Phone: +381 11 328 10 41

Iskra Hong Kong Ltd.

33 Canton Road, T.S.T.
1705, China HK City
Phone: +852 273 00 917

ISKRA ELECTRONICS GmbH

Südliche Münchner Str. 55
82031 Grünwald
Deutschland



Iskra, d.o.o.
Stegne 21
SI-1000 Ljubljana, Slovenia

Phone: +386 (0) 1 513 10 00
www.iskra.eu