



MULTIFUNCTION METER iMC740

- MEASUREMENTS OF INSTANTANEOUS VALUES OF MORE THAN **140 QUANTITIES**.
- **CLASS S** MEASURING ACCURACY ACCORDING TO EN 61000-4-30.
- VOLTAGE AND CURRENT AUTO RANGE MEASUREMENTS UP TO 1000 V_{TRMS}, 12.5 A.
- **WIDE FREQUENCY** MEASUREMENT **RANGE** 16 HZ – 400 HZ.
- UP TO **THREE INDEPENDENT COMMUNICATION PORTS**.
- SUPPORT FOR **NTP REAL TIME SYNCHRONISATION**.
- UP TO **4 INPUTS/OUTPUTS**.

FEATURES

- Measurements of instantaneous values of more than 140 quantities including harmonics, unbalance, etc..
- Class S (0.2%) accuracy in compliance with EN 61557-12.
- Four quadrant energy measurement with class 0.5 S or 0.2 S for active energy (8 programmable energy counters, up to four tariffs, tariff clock, etc.).
- Automatic range selection of 3 current and 4 voltage channels (max. 12.5 A and 1000 V_{TRMS}) with 32 kHz sampling rate.
- Measurements of 40 minimal and maximal values in different time intervals (from 1 period to 256 periods).
- Frequency range from 16 Hz to 400 Hz.
- Up to three independent communication ports (RS232 or RS485 up to 115,200 bit/s, Ethernet and USB 2.0).
- MODBUS and DNP3 communication protocols.
- Support for NTP real time synchronisation.
- Up to 4 inputs and outputs (analogue inputs/outputs, digital inputs/outputs, alarm/watchdog outputs, pulse input/outputs, tariff inputs).
- Multilingual support.
- Universal power supply.
- 96 mm square panel mounting.
- User-friendly setting and evaluation software, MiQen.
- Extension unit with four configurable analogue outputs – EX104 (0.4 mA_{DC} ... 20 mA_{DC}, 0 V_{DC} ... 10 V_{DC}).

DESCRIPTION

The iMC740 Multifunction Meter is an important device for permanent monitoring measuring and analysing single-phase or three-phase electrical power network.

The meter measures TRMS value according to the principle of fast sampling of voltage and current signals. A built-in microprocessor calculates measurands (voltage, current, frequency, energy, power, power factor, THD phase angles, etc.) from the measured signals.

The iMC740 Multifunction Meter performs measurements in compliance with regulatory requested standard EN 61557-12.

With the RS232/RS485 or Ethernet/USB communication, the meter can be set, and measurements checked.

APPLICATION AND BENEFITS

The iMC740 Multifunction Meter is intended for monitoring and measuring of electrical quantities of a three-phase electric-energy distribution system.

Identifying relevant fixed measuring points is the most important task prior to complete system installation. This system itself will not prevent disturbances in network but will help diagnose their origin and effects. This is possible only with a system approach by using time synchronized meters with wide range of measuring parameters.

COMPLIANCE WITH STANDARDS

The iMC740 Multifunction Meter follows required procedures and meets the precision requirements for class S measuring device as described in standard IEC EN 61557-12.

Standard EN	Description
61010-1	Safety requirements for electrical equipment for measurement, control and laboratory use.
61557-12	Electrical safety in LV distribution systems up to 1 kV a.c. and 1.5 kV d.c. – Combined performance measuring and monitoring devices for electrical parameters.
61000-4-7:2002 + A1	Electromagnetic compatibility (EMC) – General guide on harmonics and inter-harmonics measurements.
50160	Voltage characteristics of electricity supplied by public distribution networks.
62053-22	Electricity metering equipment - Static meters for active energy (classes 0.2 S and 0.5 S).
62053-24	Electricity metering equipment – Static meters for reactive energy at fundamental frequency (classes 0,5 S, 1 S and 1).
62053-23	Electricity metering equipment -Static meters for reactive energy (classes 2 and 3).
61326-1	EMC requirements for electrical equipment for measurement, control and laboratory use.
60529:1997/A1	Degrees of protection provided by enclosures (IP code).
60068-2-1/ -2/ -6/ -27/-30	Environmental testing (-1 Cold, -2 Dry heat, -30 Damp heat, -6 Vibration, -27 Shock).
UL 94	Tests for flammability of plastic materials for parts in devices and appliances.

Table 1: List of applicable standards

MEASUREMENTS

ONLINE MEASUREMENTS

Online measurements are available on display or can be monitored with setting and monitoring software **MiQen**.

Readings on display are performed continuously with refresh time dependent on set average interval whereas rate of readings monitored with **MiQen** is fixed and refreshed approx. each second.

For better overview over numerous readings, they are divided into several groups, which contain basic measurements, min. and max. values, harmonics and alarms.

Each group can represent data in visually favored graphical form or detailed tabular form. Latter allows freezing readings and/or copying data into various report generation software tools.

INTERACTIVE INSTRUMENT

Additional communication feature of a device allows interactive handling with a dislocated device as if it would be operational in front of user.

This feature is useful for presentations or product training.



SELECTION OF AVAILABLE QUANTITIES

Available online measuring quantities and their appearance can vary according to set type of power network and other settings such as

average interval, max. demand mode, reactive power calculation method ...

Complete selection of available online measuring quantities is shown in a table on the next page.

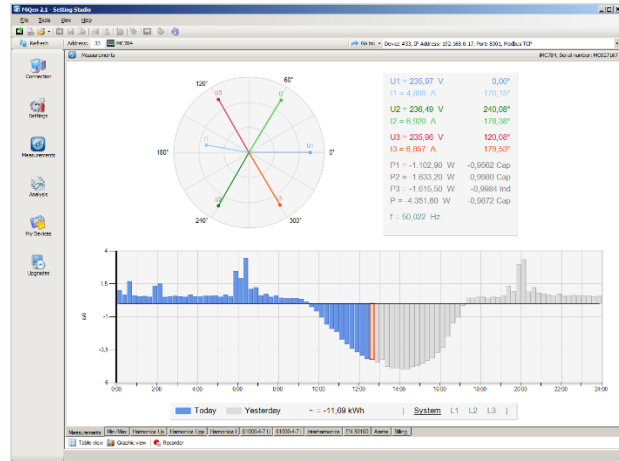

Figure 1: The sample of online measurements in graphical form – phase diagram and daily total active power consumption histogram

Measurements	L1	L2	L3	Total	Others
Phase measurements	225.51 V	225.14 V	225.54 V	17.54 A	LPF = 225.05 V
Current	2.92 A	5.86 A	8.76 A	17.54 A	I ² = 5.85 A
Active Power	0.269 kW	0.541 kW	0.808 kW	1.617 kW	
Reactive Power	-0.601 kvar	-1.202 kvar	-1.793 kvar	-3.600 kvar	
Apparent Power	0.658 kVA	1.315 kVA	1.971 kVA	3.947 kVA	
Power Factor	1.000 Ind	0.4102 Cap	0.4096 Cap	0.4097 Cap	
Power Angle	0.00°	-43.95°	-43.99°	-43.97°	
Displacement Power Factor	1.000 Ind	0.7080 Cap	0.7186 Cap	0.7183 Cap	
THD-Lip	2.76 %	2.76 %	2.76 %	2.76 %	
THDI	142.59 %	142.01 %	142.32 %	142.32 %	
TDDI	0.23 %	0.47 %	0.71 %	0.71 %	
Fundamental Reactive Power (Qnd)	-0.264 kvar	-0.525 kvar	-0.791 kvar	-1.584 kvar	
Deformed Power (D)	0.538 kvar	1.077 kvar	1.619 kvar	3.224 kvar	
Wfactor	75.37	72.99	73.60	73.60	
Current Crest factor	403.4 %	403.5 %	403.5 %	403.5 %	
Voltage Crest factor	140.6 %	140.6 %	140.6 %	140.6 %	
DC Voltage	1.03 V	1.94 V	0.68 V		
Phase to phase measurements	L1-L2	L2-L3	L3-L1	Total	Others
Phase to phase voltage	0.00 V	0.00 V	0.00 V		U _{net} = 0.00 V
Phase Angle	-0.03°	0.01°	0.00°		
THD-Lip	0.00 %	0.00 %	0.00 %		
Crest factor	0.0 %	0.0 %	0.0 %		
DC Voltage	-0.01 V	0.35 V	-0.35 V		DC
Neutral line	Measured	Angle	Calculated	Error	DC
Current	0.25 A	0.00°	17.56 A	17.56 A	0.43 V
Neutral line	192.11 V	-161.11°			

Figure 2: The sample of online measurements in tabular form

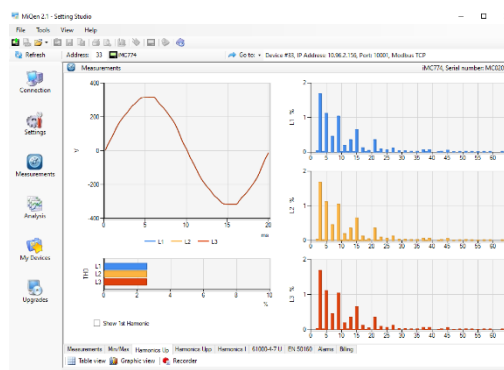















Figure 3: The sample of online harmonic measurements in graphical form

Meas. type	Measurement	3-phase 4-wire	3-phase 3-wire	1-phase	comments
Phase measurements	<i>Voltage</i>				
	U _{1-3_TRMS}	<input checked="" type="checkbox"/>		<input checked="" type="checkbox"/> 1ph	
	U _{AVG_TRMS}	<input checked="" type="checkbox"/>		<input checked="" type="checkbox"/>	
	U _{1-3_DC}	<input checked="" type="checkbox"/>		<input checked="" type="checkbox"/> 1ph	DC component of phase voltages
	<i>Current</i>				
	I _{1-3_TRMS}	<input checked="" type="checkbox"/>	<input checked="" type="checkbox"/>	<input checked="" type="checkbox"/> 1ph	
	I _{TOT_TRMS}	<input checked="" type="checkbox"/>	<input checked="" type="checkbox"/>	<input checked="" type="checkbox"/>	
	I _{AVG_TRMS}	<input checked="" type="checkbox"/>	<input checked="" type="checkbox"/>	<input checked="" type="checkbox"/>	
	I _{NEUTRAL_calc}	<input checked="" type="checkbox"/>	<input checked="" type="checkbox"/>	<input checked="" type="checkbox"/>	Calculated neutral current
	<i>Power</i>				
	P _{1-3_TRMS}	<input checked="" type="checkbox"/>		<input checked="" type="checkbox"/> 1ph	
	P _{TOT_TRMS}	<input checked="" type="checkbox"/>	<input checked="" type="checkbox"/>	<input checked="" type="checkbox"/>	
	Q _{1-3_TRMS}	<input checked="" type="checkbox"/> 		<input checked="" type="checkbox"/> 1ph 	Reactive power can be calculated as a squared difference between S and P or as delayed sample
	Q _{TOT_TRMS}	<input checked="" type="checkbox"/>	<input checked="" type="checkbox"/>	<input checked="" type="checkbox"/>	
	S _{1-3_TRMS}	<input checked="" type="checkbox"/>		<input checked="" type="checkbox"/> 1ph	
	S _{TOT_TRMS}	<input checked="" type="checkbox"/>	<input checked="" type="checkbox"/>	<input checked="" type="checkbox"/>	
	Q _{fund1-3_TRMS}	<input checked="" type="checkbox"/> 		<input checked="" type="checkbox"/> 1ph 	Fundamental reactive power of first harmonics
	Q _{fundTOT_TRMS}	<input checked="" type="checkbox"/>	<input checked="" type="checkbox"/>	<input checked="" type="checkbox"/>	
	PF ₁₋₃	<input checked="" type="checkbox"/>		<input checked="" type="checkbox"/> 1ph	
	PF _{TOT}	<input checked="" type="checkbox"/>	<input checked="" type="checkbox"/>	<input checked="" type="checkbox"/>	
	φ ₁₋₃	<input checked="" type="checkbox"/>		<input checked="" type="checkbox"/> 1ph	PA – Power angle
	<i>Harmonic analysis</i>				
	THD-U ₁₋₃	<input checked="" type="checkbox"/>		<input checked="" type="checkbox"/> 1ph	
	THD-I ₁₋₃	<input checked="" type="checkbox"/>	<input checked="" type="checkbox"/>	<input checked="" type="checkbox"/> 1ph	
	TDD-I ₁₋₃	<input checked="" type="checkbox"/>	<input checked="" type="checkbox"/>	<input checked="" type="checkbox"/> 1ph	
	U _{1-3_harmonic_1-63_%}	<input checked="" type="checkbox"/> 		<input checked="" type="checkbox"/> 1ph 	% of TRMS or % of base
	U _{1-3_harmonic_1-63_ABS}	<input checked="" type="checkbox"/>		<input checked="" type="checkbox"/> 1ph	
	U _{1-3_harmonic_1-63_φ}	<input checked="" type="checkbox"/>		<input checked="" type="checkbox"/> 1ph	
U _{1-3_signaling_ABS}	<input checked="" type="checkbox"/>		<input checked="" type="checkbox"/> 1ph		
I _{1-3_harmonic_1-63_%}	<input checked="" type="checkbox"/> 	<input checked="" type="checkbox"/> 	<input checked="" type="checkbox"/> 1ph 	% of TRMS or % of base	
I _{1-3_harmonic_1-63_ABS}	<input checked="" type="checkbox"/>	<input checked="" type="checkbox"/>	<input checked="" type="checkbox"/> 1ph		
I _{1-3_harmonic_1-63_φ}	<input checked="" type="checkbox"/>	<input checked="" type="checkbox"/>	<input checked="" type="checkbox"/> 1ph		
Phase to phase measurements	<i>Voltage</i>				
	U _{pp1-3_TRMS}	<input checked="" type="checkbox"/>	<input checked="" type="checkbox"/>		
	U _{ppAVG_TRMS}	<input checked="" type="checkbox"/>	<input checked="" type="checkbox"/>		
	φ _{x-y}	<input checked="" type="checkbox"/>	<input checked="" type="checkbox"/>		Phase-to-phase angle
	<i>Harmonic analysis</i>				
	THD-U _{pp1-3}	<input checked="" type="checkbox"/>	<input checked="" type="checkbox"/>		
	U _{pp1-3_harmonic_1-63_%}	<input checked="" type="checkbox"/> 	<input checked="" type="checkbox"/> 		% of TRMS or % of base
	U _{pp1-3_harmonic_1-63_ABS}	<input checked="" type="checkbox"/>	<input checked="" type="checkbox"/>		
	U _{pp1-3_harmonic_1-63_φ}	<input checked="" type="checkbox"/>	<input checked="" type="checkbox"/>		

Meas. type	Measurement	3-phase 4-wire	3-phase 3-wire	1-phase	comments
Metering	Energy				
	Counter E ₁₋₈	<input checked="" type="checkbox"/>	<input checked="" type="checkbox"/>	<input checked="" type="checkbox"/>	Each counter can be dedicated to any of four quadrants (P-Q, import-export, L-C). Total energy is a sum of one counter for all tariffs. Tariffs can be fixed, date/time dependent or tariff input dependent
	E _{TOT_1-8}	<input checked="" type="checkbox"/>	<input checked="" type="checkbox"/>	<input checked="" type="checkbox"/>	
	Active tariff	<input checked="" type="checkbox"/>	<input checked="" type="checkbox"/>	<input checked="" type="checkbox"/>	
	Cost _{by_meters} ₁₋₄	<input checked="" type="checkbox"/>	<input checked="" type="checkbox"/>	<input checked="" type="checkbox"/>	Calculated costs depend on specified price per hour and currency
	Cost _{1-4_TOT}	<input checked="" type="checkbox"/>	<input checked="" type="checkbox"/>	<input checked="" type="checkbox"/>	
	Billing	<input checked="" type="checkbox"/>	<input checked="" type="checkbox"/>	<input checked="" type="checkbox"/>	
Maximum demand measurements	Maximum demand				
	MD _I ₁₋₃	<input checked="" type="checkbox"/>	<input checked="" type="checkbox"/>	<input checked="" type="checkbox"/> 1ph	
	MD _P _{import}	<input checked="" type="checkbox"/>	<input checked="" type="checkbox"/>	<input checked="" type="checkbox"/>	
	MD _P _{export}	<input checked="" type="checkbox"/>	<input checked="" type="checkbox"/>	<input checked="" type="checkbox"/>	
	MD _Q _{ind}	<input checked="" type="checkbox"/>	<input checked="" type="checkbox"/>	<input checked="" type="checkbox"/>	
	MD _Q _{cap}	<input checked="" type="checkbox"/>	<input checked="" type="checkbox"/>	<input checked="" type="checkbox"/>	
	MD _S	<input checked="" type="checkbox"/>	<input checked="" type="checkbox"/>	<input checked="" type="checkbox"/>	
Min and max measurements	Min and max				
	U _{1-3_TRMS_MIN}	<input checked="" type="checkbox"/>		<input checked="" type="checkbox"/> 1ph	
	U _{1-3_TRMS_MAX}	<input checked="" type="checkbox"/>		<input checked="" type="checkbox"/> 1ph	
	U _{pp} _{1-3_TRMS_MIN}	<input checked="" type="checkbox"/>	<input checked="" type="checkbox"/>	<input checked="" type="checkbox"/>	
	U _{pp} _{1-3_TRMS_MAX}	<input checked="" type="checkbox"/>	<input checked="" type="checkbox"/>	<input checked="" type="checkbox"/>	
	I _{1-3_TRMS_MIN}	<input checked="" type="checkbox"/>	<input checked="" type="checkbox"/>	<input checked="" type="checkbox"/> 1ph	
	I _{1-3_TRMS_MAX}	<input checked="" type="checkbox"/>	<input checked="" type="checkbox"/>	<input checked="" type="checkbox"/> 1ph	
	P _{1-3_TRMS_MIN}	<input checked="" type="checkbox"/>		<input checked="" type="checkbox"/> 1ph	
	P _{1-3_TRMS_MAX}	<input checked="" type="checkbox"/>		<input checked="" type="checkbox"/> 1ph	
	P _{TOT_TRMS_MIN}	<input checked="" type="checkbox"/>	<input checked="" type="checkbox"/>	<input checked="" type="checkbox"/> 1ph	
	P _{TOT_TRMS_MAX}	<input checked="" type="checkbox"/>	<input checked="" type="checkbox"/>	<input checked="" type="checkbox"/> 1ph	
	S _{1-3_TRMS_MIN}	<input checked="" type="checkbox"/>		<input checked="" type="checkbox"/> 1ph	
	S _{1-3_TRMS_MAX}	<input checked="" type="checkbox"/>		<input checked="" type="checkbox"/> 1ph	
	S _{TOT_TRMS_MIN}	<input checked="" type="checkbox"/>	<input checked="" type="checkbox"/>	<input checked="" type="checkbox"/> 1ph	
	S _{TOT_TRMS_MAX}	<input checked="" type="checkbox"/>	<input checked="" type="checkbox"/>	<input checked="" type="checkbox"/> 1ph	
	freq _{MIN}	<input checked="" type="checkbox"/>	<input checked="" type="checkbox"/>	<input checked="" type="checkbox"/>	
	freq _{MAX}	<input checked="" type="checkbox"/>	<input checked="" type="checkbox"/>	<input checked="" type="checkbox"/>	
Other measurements	Miscellaneous				
	freq _{MEAN}	<input checked="" type="checkbox"/>	<input checked="" type="checkbox"/>	<input checked="" type="checkbox"/>	
	Internal temp.	<input checked="" type="checkbox"/>	<input checked="" type="checkbox"/>	<input checked="" type="checkbox"/>	
	Date, Time	<input checked="" type="checkbox"/>	<input checked="" type="checkbox"/>	<input checked="" type="checkbox"/>	
	Last Sync. time	<input checked="" type="checkbox"/> 	<input checked="" type="checkbox"/> 	<input checked="" type="checkbox"/> 	UTC

 For more information see *iMC7x0 Power Monitoring Device* User's manual

Table 3: Selection of available measurement quantities

DESCRIPTION OF PROPERTIES

Memory card

The **iMC740 Multifunction Meter** is equipped with a front panel slot for full sized SD memory card that supports capacity up to 2 GB. It is intended for setting file and performing firmware upgrade.

Alarms

Alarms are powerful tool for **the iMC740 Multifunction Meter** control and supervision features. Devices' performance can with this features reach beyond measuring and analyzing power network.

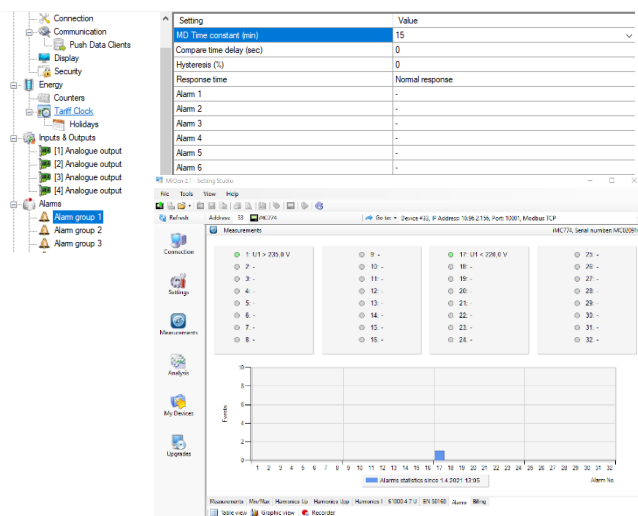

Figure 4: The sample of setting and viewing alarms

REAL TIME SYNCHRONISATION

For this purpose, instruments normally support highly accurate internal RTC. Still this is not enough, since temperature is location dependant and it influences its precision. For that reason, it is required to implement periodical RTC synchronization.

The **iMC740 Multifunction Meter** supports Network time protocol synchronization (NTP).

Network time protocol (NTP):

Synchronization via Ethernet requires access to an NTP server.

PLEASE NOTE: NTP can usually maintain time to within tens of milliseconds over the public Internet, but the accuracy depends on infrastructure properties - asymmetry in outgoing and incoming communication delay affects systematic bias. It is recommended that dedicated network rather than public network is used for synchronisation purposes.

COMMUNICATION

The **iMC740 Multifunction Meter** has a wide variety of communication possibilities to suit specific demands. It is equipped with standard communication port COM1 and auxiliary communication port COM2. This allows two different users to access data from a device simultaneously and by using TCP/IP communication, data can be accessed worldwide.

COM2 port is optional and can be ordered as one of I/O modules.

Different configurations are possible (to be specified with an order).

Configuration	COM1	COM2
1	RS232/485	/
2	RS232/485	RS232 or RS485
3 ⁽¹⁾	Ethernet & USB	/
4 ⁽¹⁾	Ethernet & USB	RS232 or RS485

⁽¹⁾ Galvanic separation between Eth. and USB is 1 kVACRMS

Table 4: List of communication configurations

The **iMC740 Multifunction Meter** supports standard communication protocols MODBUS RTU, TCP and DNP3 L1.

Analogue extender EX104 (accessory)

If there is a demand for additional analogue outputs, analogue extender EX104 can be used.

It is a standalone unit, connected to meter via module 2 (module for communication with EX104 needs to be specified at order). Up to 4 analogue outputs can be used with one extender. Up to 4 extender EX104 can be used with one iMC740 meter. More information can be found in Analogue extender EX104 data sheet (E P22.495.400).

TECHNICAL DATA

Measurement inputs

Nominal frequency range	50 Hz, 60 Hz
Measuring frequency range	16 Hz–400 Hz

Voltage measurements:

Number of channels	4 ⁽¹⁾
Sampling rate	32 kHz
Min. voltage for sync.	1 V _{TRMS}
Nominal value (U _N)	500 V _{LN} , 866 V _{LL}
Max. measured value (cont.)	600 V _{LN} ; 1000 V _{LL}
Max. allowed value	1.2 × U _N permanently 2 × U _N ; 10 s
Consumption	< U ² / 4.2MΩ per phase
Input impedance	4.2MΩ per phase

⁽¹⁾ 4th channel is used for measuring U_{EARTH-NEUTRAL}

Current measurements:

Number of channels	3
Sampling rate	32 kHz
Nominal value (I _{NOM})	1 A, 5 A
Max. measured value (I ₁ -I ₃ only)	12.5 A sin.
Max. allowed value (thermal)	15 A cont.
Consumption	≤ 300 A; 1s < I ² × 0.01Ω per phase

Basic accuracy under reference conditions

Accuracy is presented as percentage of reading of the measurand except when it is stated as an absolute value.

Measurand	Accuracy class	According to
Voltage L-N, L-L	0.2	EN 61557-12
Current	0.2	EN 61557-12
Active power (I _N = 5 A)	0.2	EN 61557-12
Active power (I _N = 1 A)	0.5	EN 61557-12
Active energy	0.5S	EN 62053-22
Reactive energy	1	EN 62053-24
Frequency (f)	0.02 Class A	EN 61557-12
Power factor (PF)	0.5	EN 61557-12
THD (U)	0.3 Class A / I	EN 61557-12
THD (I)	0.3	EN 61557-12
Real time clock (RTC)	< ± 1 s/day	IEC 61000-4-30

For complete overview of accuracy for all measured parameters and measuring ranges see Users' manual.

INPUT/OUTPUT modules

The **iMC740 Multifunction Meter** is equipped with two main I/O slots. According to order, each slots' function can be as presented in a table below.

Module type	Number of I/O per module
Relay output (RO)	2
Analogue output (AO)	2 x 20 mA
Analogue input (AI)	2
Pulse output (PO)	2
Pulse input (PI)	2
Bistable Digital output (BO)	1
Digital output (DO)	2
Digital input (DI)	2
Tariff input (TI)	2
Additional communication port (COM2)	1
Status output (WO)	1 + 1xRO
Communication port for analogue extender EX104	1

Table 5: List of available I/O modules

Analogue input:

Three types of analogue inputs are suitable for acquisition of low voltage DC signals from different sensors. According to application requirements it is possible to choose current, voltage or resistance (temperature) analogue input. They all use the same output terminals.

MiQen software allows setting an appropriate calculation factor, exponent and required unit for representation of primary measured value (temperature, pressure, wind speed ...).

DC current input:

Nominal input range	-20 mA...0...20 mA (±20%)
Input resistance	20 Ω
Accuracy	0.5 % of range
Temperature drift	0.01% / °C
Conversion resolution	16 bit (sigma-delta) internally referenced
Analogue input mode	Single-ended

DC voltage input:

Nominal input range	-10 V...0...10 V (±20%)
Input resistance	100 kΩ
Accuracy	0.5 % of range
Temperature drift	0.01% / °C
Conversion resolution	16 bit (sigma-delta) internally referenced
Analogue input mode	Single-ended

Resistance (temperature) input:

Nominal input range (low)*	0 Ω - 200 Ω (max. 400 Ω) PT100 (-200°C–850°C)
Nominal input range (high)*	0 kΩ – 2 kΩ (max. 4 kΩ) PT1000 (-200°C–850°C)
Connection	2-wire
Accuracy	0.5 % of range
Conversion resolution	16 bit (sigma-delta) internally referenced
Analogue input mode	Single-ended

* Low or high input range and primary input value (resistance or temperature) are set by the MiQen setting software

Analogue output:

Output range	0 mA...20 mA
Accuracy	0.5% of range
Max. burden	150 Ω
Linearization	Linear, Quadratic
No. of break points	5
Output value limits	± 120% of nominal output
Response time (measurement and analogue output)	depends on set general average interval (0.1 s – 5 s)
Residual ripple	< 1 % p.p.

Outputs may be either short or open-circuited. They are electrically insulated from each other and from all other circuits.

Output range values can be altered subsequently (zoom scale) using the setting software, but a supplementary error results.

Digital input:

Purpose	Tariff input, Pulse input, General purpose digital input
---------	--

Tariff input

No. of inputs per module	2
Rated voltage	5 V...48 V _{AC/DC} * 110 ± 20 % V _{AC/DC} * 230 ± 20 % V _{AC/DC} *
Frequency range	45 Hz...65 Hz

*Depends on a build in hardware

Pulse input

No. of inputs per module	2
Rated voltage	5 V- 48 V _{DC} (±20 %)
Max. current	8 mA (at 48 V _{DC} + 20 %)
Min. pulse width	0.5 ms
Min. pulse period	2 ms
SET voltage	(40...120) % of rated voltage
RESET voltage	(0...10) % of rated voltage

General purpose digital input

No. of inputs per module	2
Voltage	5 V...48 V _{AC/DC} * 110 ± 20 % V _{AC/DC} * 230 ± 20 % V _{AC/DC} *

*Depends on a build in hardware

Digital output:

Type	Relay switch
No. of outputs per module	2
Purpose	Alarm output, General purpose Digital output, Pulse output, Status output (watchdog)
Rated voltage	230 V _{AC/DC} ± 20% max
Max. switching current	1000 mA
Contact resistance	≤ 100 mΩ (100 mA, 24 V)
Impulse	Max. 4000 imp/hour Min. length 100 ms

Type	Bistable Relay switch
No. of outputs per module	1
Purpose	Alarm output, General purpose digital output
Max. switching power	40 VA
Rated voltage	230 V _{AC/DC} ± 20% max
Max. switching current	1000 mA
Contact resistance	≤ 100 mΩ (100 mA, 24 V)

Type	Optocoupler open collector switch
No. of outputs per module	2
Purpose	Pulse output
Rated voltage	40 V _{AC/DC}
Max. switching current	30 mA (R _{ONmax} = 8 Ω)
Pulse length	programmable (2 ms... 999 ms)

Type	Relay switch
No. of outputs	1 x watchdog + 1 x relay output
Normal operation	Relay in ON position
Failure detection delay	≈ 1.5 s
Rated voltage	230 V _{AC/DC} ± 20 % max
Max. switching current	1000 mA
Contact resistance	≤ 100 mΩ (100 mA, 24 V)

Power Supply

Standard:	CAT III 300V
Nominal voltage AC	48 V... 276 V
Nominal frequency	40 Hz... 65 Hz
Nominal voltage DC	20 V... 300 V
Consumption (max. all I/O)	< 8 VA
Power-on transient current	< 20 A; 1 ms

AC power supply	CAT III 300 V
Nominal voltage AC	110 V, 230 V or 400 V
Nominal frequency	40 Hz... 65 Hz
Consumption (max. all I/O)	< 8 VA

Safety

Safety: protection class II
functional earth terminal must be connected to earth potential!



Voltage inputs via high impedance
Double insulation for I/O ports and COM ports

Pollution degree: 2
Test voltages: U_{AUX} against SELV circuits – 3.51 kV RMS
Other circuits to functional earth – 2.21 kV RMS

EMC: Directive on electromagnetic compatibility 2004/108/EC
In compliance with EN 61326-1:2013 for industrial environment

Protection: In compliance with EN 60529: 1997/A1:2000
Front side (with protection cover for memory slot): IP40
Rear side (with protection cover): IP20

Mechanical

Dimensions	96 mm × 96 mm × 96.5 mm
Mounting	Panel mounting 96 mm × 96 mm 92 mm × 92 mm
Required mounting hole	
Enclosure material	PC/ABS
Flammability	Acc. to UL 94 V-0
Weight	550 g
Enclosure material	PC/ABS Acc. to UL 94 V-0

Ambient conditions

Ambient temperature	K55 temperature class Acc. to EN 61557-12 -10 °C ... 55 °C
Storage temperature	-40 °C to +70 °C
Ambient humidity	≤ 75% r.h. (no condensation)
Max. storage and transport humidity	≤ 90% r.h. (no condensation)
Voltage and current max. temperature influence limit	± 20 ppm / K (10 V-600 V; 0.05 A-10 A) (T_{amb} : -30°C to +70°C)

Real time clock

A built-in real time clock is also without external synchronization very stable when device is connected to auxiliary power supply. For handling shorter power interruptions without influence on RTC, device uses high capacity capacitor battery. It ensures auxiliary supply (for internal RTC only) for more than two days of operation (6 years with battery).

To enable clock operation backup supercap or battery is built-in.

<i>Supercap life span</i>	<i>approx. 2 days</i>
<i>Type</i>	<i>Low power embedded RTC</i>
<i>RTC stability</i>	<i>< 1 sec / day</i>
<i>Battery life span</i>	<i>approx. 6 years (at 23 °C)</i>

Connection cables

The **iMC740 Multifunction Meter** is equipped with European style pluggable terminals for measuring voltages, auxiliary supply, communication and I/O modules.

Measuring current cables can be connected in two ways. They shall be attached as through-hole connection without screwing or as detachable screw terminals.

PLEASE NOTE: Stranded wire must be used with insulated end sleeve to assure firm connection.

<i>Voltage inputs (4)</i>	<i>≤ 2.5 mm² , AWG 24-12 single wire</i>
<i>Current inputs (3)</i>	<i>≤ ∅ 6 mm one conductor with insulation</i>
<i>Supply (3)</i>	<i>≤ 2.5 mm² , AWG 24-12 single wire</i>
<i>Com (5), I/O (6)</i>	<i>≤ 2.5 mm² , AWG 24-12 single wire</i>

MiQen - setting and acquisition Software

MiQen software is intended for supervision of the **iMC740** and many other instruments on a PC. Network and the device setting, display of measured and stored values and analysis of stored data in the device are possible via the serial, Ethernet or USB communication. The information and stored measurements can be exported in standard Windows formats. Multilingual software functions on Windows XP operating system or higher.

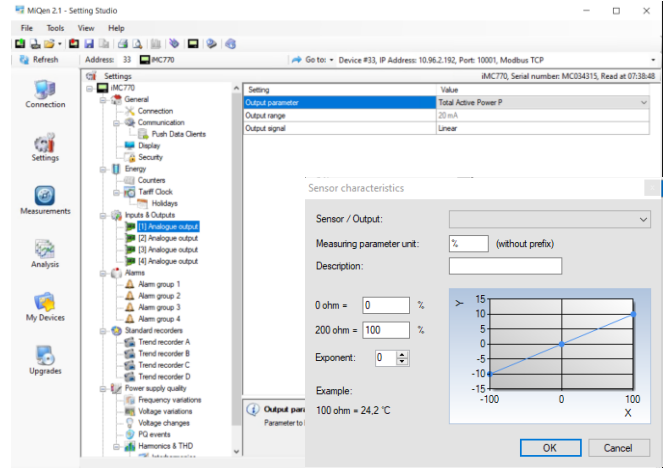

Figure 5: MiQen setting and acquisition software

MiQen software is intended for:

- Setting all of the instruments parameters (online and offline).
- Viewing current measured readings.
- Setting and resetting energy counters.
- Complete I/O modules configuration.
- Upgrading instruments firmware.
- Searching the net for devices.
- Virtual interactive instrument.
- Comprehensive help support.

PLEASE NOTE!
MiQen software functions depend on the type of connected device.

CONNECTION

Two possible connections of current are available, through-hole connection and terminal connection (see pictures below).

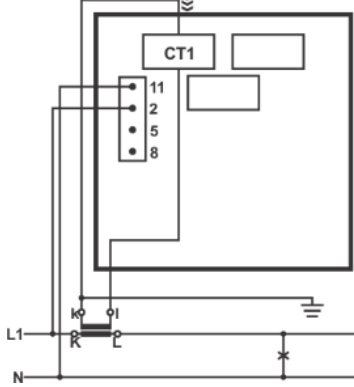
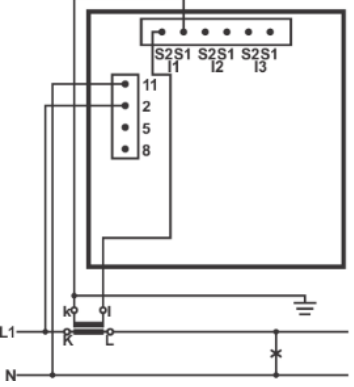
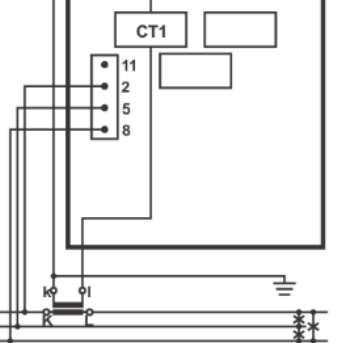
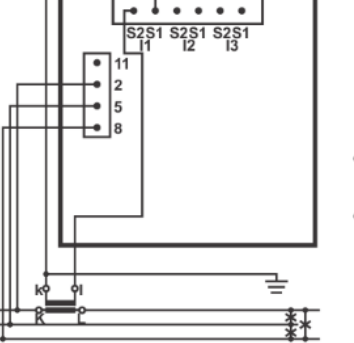
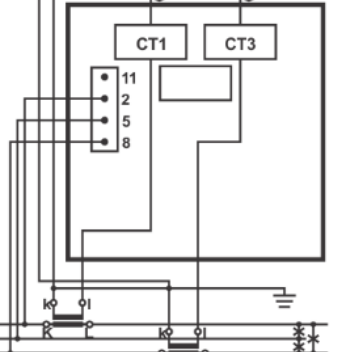
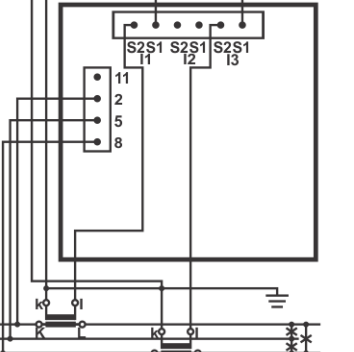
System/connection	Through-hole connection assignment	Terminal connection assignment
<p>1b (1W1b)</p> <p>Single-phase connection.</p>		
<p>3b (1W3b)</p> <p>Three-phase, three-wire connection with balanced load.</p>		
<p>3u (2W3u)</p> <p>Three-phase, three-wire connection with unbalanced load.</p>		

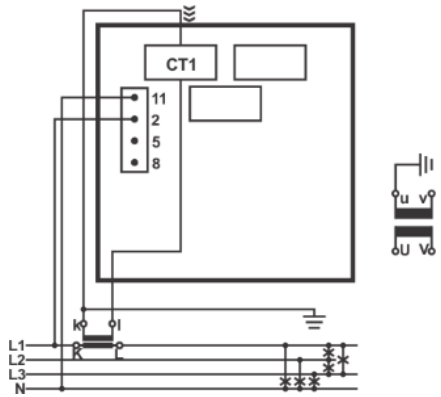
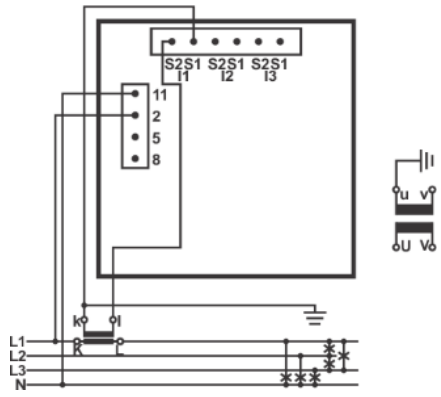
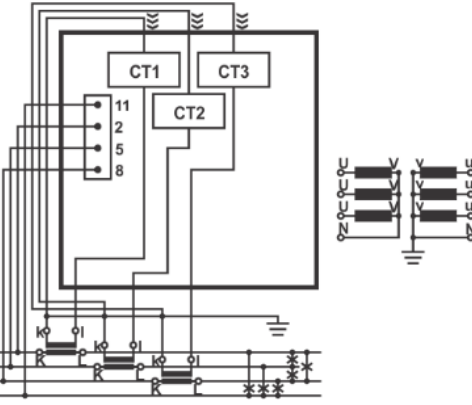
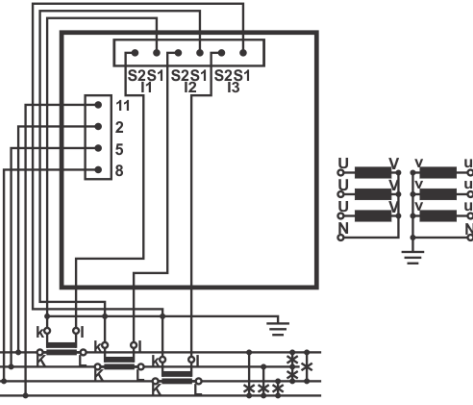
System/connection	Through-hole connection assignment	Terminal connection assignment
<p>4b (1W4b)</p> <p>Three-phase, four wire connection with balanced load.</p>		
<p>4u (3W4)</p> <p>Three-phase, four wire connection with unbalanced load.</p>		

DIMENSIONAL DRAWING

Dimensions for iMC740 (through-hole connection assignment):

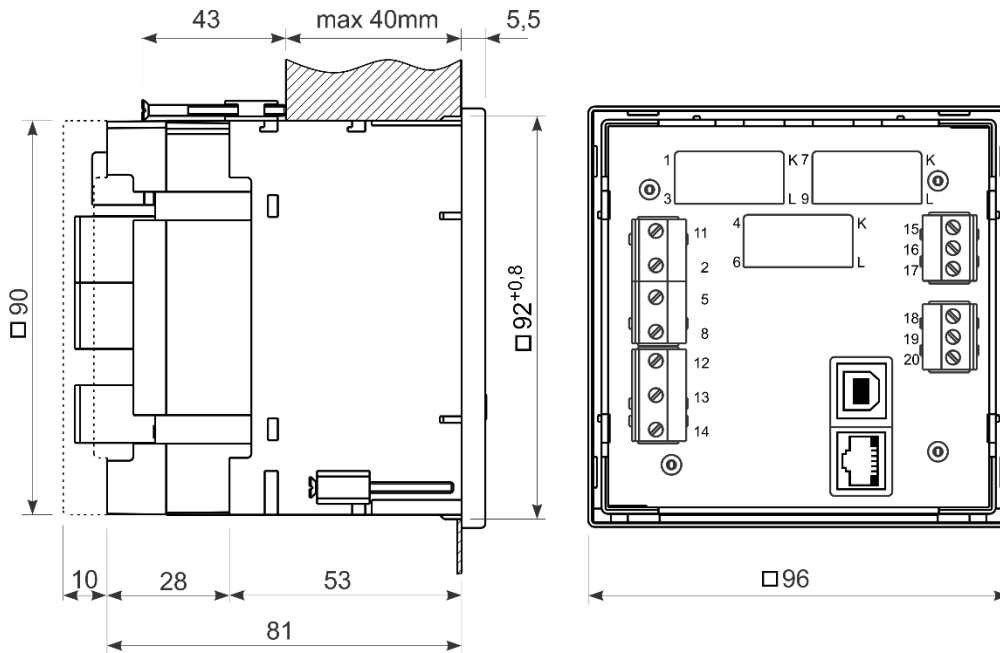

Dimensions for iMC740 (terminal connection assignment):

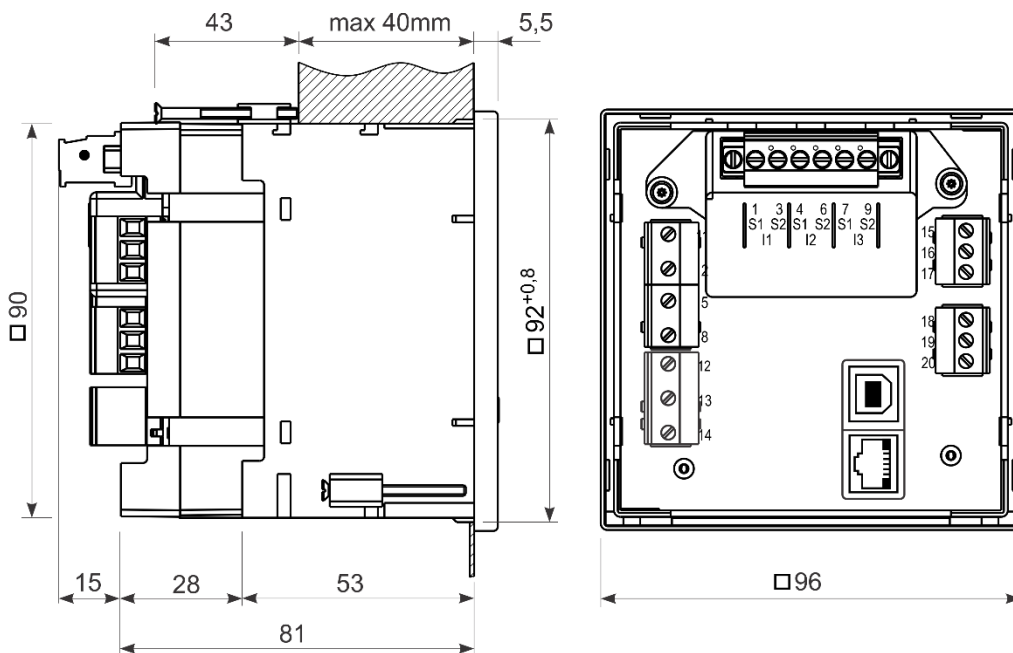

PLEASE NOTE: Terminals for communication could be chosen (see picture below).

Terminals options

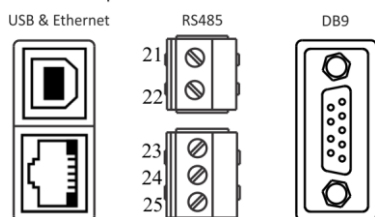

Connection table

Function			Terminals	Comment
Measuring input:	AC current	IL1	1/3	⚠ CAT II 600V CAT III 300V
		IL2	4/6	
		IL3	7/9	
	AC voltage	UL1	2	⚠ CAT II 600V CAT III 300V
		UL2	5	
		UL3	8	
UN		11		
Inputs/outputs:	Module 1/2	⊕ ₊	15	
		⊕ ₋ (common)	16	
		⊕ ₊	17	
	Module 3/4	⊕ ₊	18	
		⊕ ₋ (common)	19	
		⊕ ₊	20	
Auxiliary power supply:		+ / AC (L)	13	⚠ CAT III 300V
		- / AC (N)	14	
		GROUND	12	⚡ GROUND terminal must be always connected !!
Communication:	RS485	A	21	RS232 and RS485 are both supported, but only one at the time can be used! In case of Ethernet / USB communication, terminals from 21 to 25 are replaced with RJ45 and USB-B
		B	22	
	RS232	RX	23	
		GND	24	
		TX	25	
Communication: DB9 female	RS232	Rx	3	RS232 and RS485 are both supported, but only one at the time can be used!
		⏏	5	
		Tx	2	
	RS485	B	7	
		A	8	

Table 6: Connections

DATA FOR ORDERING

When ordering **The iMC740 Multifunction Meter**, all required specifications shall be stated in compliance with the ordering code. Additional information could be stated. PLEASE NOTE that fixed or programmable specifications are not part of ordering code.

General ordering code

The following specifications shall be stated:

Device Type	Nominal freq.	Aux. power supply	Comm. COM1	I/O module 1/2	I/O module 3/4	RTC backup supply	Current connection
iMC740	X	X	X	X	X	X	X
							T Through Hole Transformer *
							C Screw Terminal Connector *****
						C	Supercap *
						B	Battery
				N			Without *
				A			2× Analogue output ****
				S			2× Pulse output
				M			2× Relay (alarm) output
				B			1× Bistable relay (alarm) output
				W			1× Status + 1× Relay output
				I			2× Analogue input - mA _{DC}
				U			2× Analogue input - V _{DC}
				R			2× Analogue input - R/Temp.
				P			2× Pulse input 5 - 48 V _{DC}
				D			2× Digital input 230 V _{AC/DC}
				E			2× Digital input 110 V _{AC/DC}
				F			2× Digital input 5 - 48 V _{AC/DC}
				T			2× Tariff input 230 V _{AC/DC} ***
				Z			2× Tariff input 110 V _{AC/DC} ***
				Y			2× Tariff input 5 - 48 V _{AC/DC} ***
				G			RS232 Communication - COM2 **
				C			RS485 Communication - COM2 **
				X			Output Extender - COM2 **
			T				RS232 & RS485 Terminal *
			R				RS232 & 485 DB9
			E				Ethernet & USB
		U					20 ... 300 V _{DC} , 48 ... 276 V _{AC} *
		D					110 V _{AC}
		E					230 V _{AC}
		F					400 V _{AC}
	S						50, 60 Hz *
	A						400 Hz
	B						16 2/3 Hz

* - standard

** - I/O module 3/4 only

*** - I/O module 1/2 only

**** - not available for Nominal freq. 16 2/3 Hz

***** - without protection back cover

Example of ordering:

iMC740 with a universal supply is connected to 230 V voltage and 5 A secondary current on 50 Hz network. Ethernet & USB communication, watchdog output (plus one relay output) as I/O 1/2 and two pulse outputs as I/O 3/4. RTC with supercap supply. Through-hole type current transformers.

Voltage and current nominal value are due to auto-range fixed to max. nominal value and are therefore omitted from ordering code.

Connection type is user programmable and is therefore omitted from ordering code. Default is 4u connection.

Example ordering code:

```

iMC740  S  U  E  W  S  C  T
          |  |  |  |  |  |  |
          |  |  |  |  |  |  Through Hole Transformer
          |  |  |  |  |  Supercap
          |  |  |  |  2× Pulse output
          |  |  |  1× Status (Watchdog) + 1× Relay output
          |  |  Ethernet & USB
          |  Universal (20 V DC... 300 V DC, 48 V AC... 276 V AC)
          50 Hz, 60 Hz
    
```

DICTIONARY:

<i>PQ</i>	<i>Power Quality alias Voltage Quality</i>
<i>RMS</i>	<i>Root Mean Square</i>
<i>TRMS</i>	<i>True Root Mean Square</i>
<i>PA</i>	<i>Power angle (between current and voltage)</i>
<i>PF</i>	<i>Power factor</i>
<i>VT</i>	<i>Voltage measuring transformer</i>
<i>CT</i>	<i>Current measuring transformer</i>
<i>THD</i>	<i>Total harmonic distortion</i>
<i>Ethernet</i>	<i>IEEE 802.3 data layer protocol</i>
<i>MODBUS</i>	<i>Industrial protocol for data transmission</i>
<i>MiQen</i>	<i>ISKRA setting and acquisition Software</i>
<i>AC</i>	<i>Alternating quantity</i>
<i>RTC</i>	<i>Real Time Clock</i>
<i>IRIG</i>	<i>Inter-range instrumentation group time codes</i>
<i>NTP</i>	<i>Network Time Protocol</i>

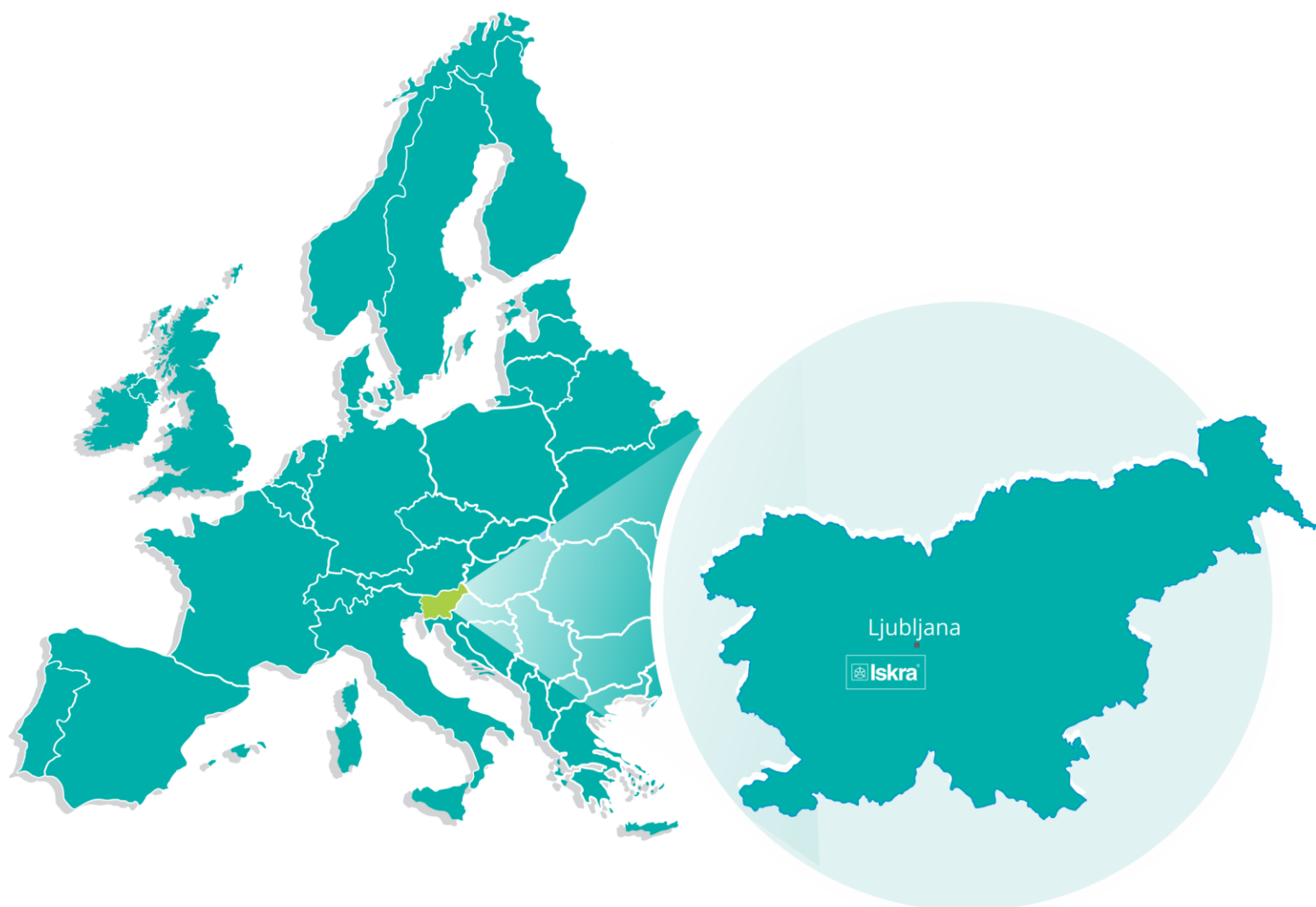

Iskra, d.o.o.
BU Ljubljana
 Stegne 21
 SI-1000, Ljubljana
 Phone: +386 1 513 10 00

Iskra, d.o.o.
BU Capacitors
 Vajdova ulica 71
 SI-8333, Semič
 Phone: +386 7 38 49 200

Iskra, d.o.o.
BU MIS
 Ljubljanska c. 24a
 SI-4000, Kranj
 Phone: +386 4 237 21 12

Iskra, d.o.o.
BU Batteries & Potentiometers
 Šentvid pri Stični 108
 SI-1296, Šentvid pri Stični
 Phone: +386 1 780 08 00

Iskra, d.o.o.
BU Electroplating
 Glinek 5
 SI-1291, Škofljica
 Phone: +386 1 366 80 50

Iskra IP, d.o.o.
 Vajdova ulica 71
 SI-8333, Semič
 Phone: +386 7 384 94 54

Iskra STIK, d.o.o.
 Ljubljanska cesta 24a
 SI-4000, Kranj
 Phone: +386 4 237 22 33

Iskra Lotrič, d.o.o.
 Ljubljanska c. 24a
 SI-4000, Kranj
 Phone: +386 4 237 21 12

Iskra ODM, d.o.o.
 Ljubljanska c. 24a
 SI-4000, Kranj
 Phone: +386 4 237 21 12

Iskra Tela L, d.o.o.
 Omladinska 66
 78250, Laktaši
 Phone: +387 51 535 890

Iskra Sistemi - M dooel
 Ul, Dame Grujev br. 16/5 kat
 1000, Skopje
 Phone: +389 75 444 498

Iskra Commerce, d.o.o.
 Hadži Nikole Živkoviča br. 2
 11000, Beograd
 Phone: +381 11 328 10 41

Iskra Hong Kong Ltd.
 33 Canton Road, T.S.T.
 1705, China HK City
 Phone: +852 273 00 917

ISKRA ELECTRONICS GmbH
 Südliche Münchner Str. 55
 82031 Grünwald
 Deutschland



Iskra, d.o.o.
 Stegne 21
 SI-1000 Ljubljana, Slovenia

Phone: +386 (0) 1 513 10 00
www.iskra.eu